

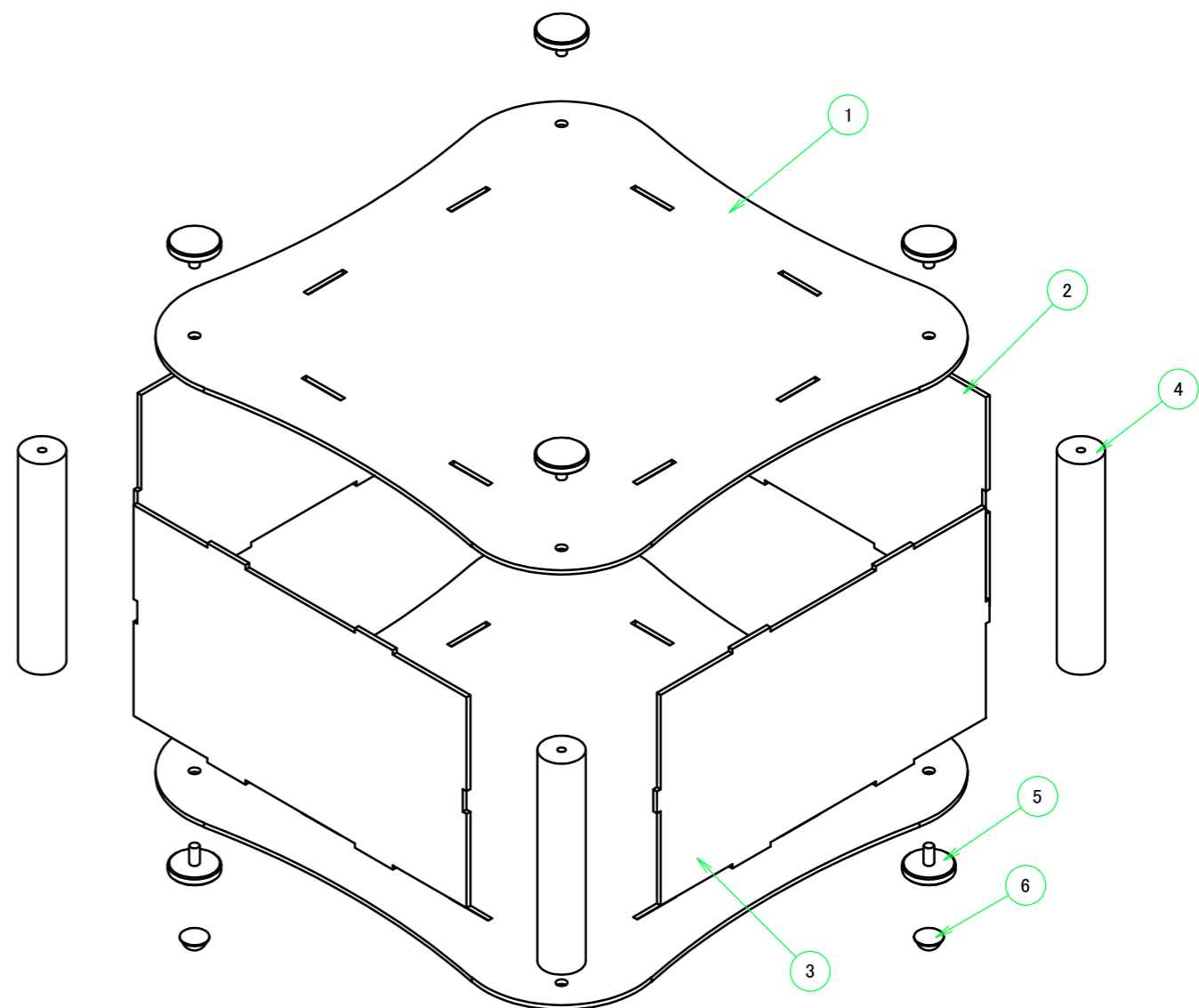

構成内容 / Components				
No.	名称 / Part name	数量 / Pcs	材質 / Material	色・表面処理 / Color・Finish
1	上下カバー Top and Bottom cover	各1 1 each	アルミ板 A1100P t2.0 Aluminium A1100P t2.0	シルバーアルマイト Silver・Anodized
2	Wパネル W Panel	2	アルミ板 A1100P t2.0 Aluminium A1100P t2.0	シルバーアルマイト Silver・Anodized
3	Dパネル D Panel	2	アルミ板 A1100P t2.0 Aluminium A1100P t2.0	シルバーアルマイト Silver・Anodized
4	支柱 Extruded Pillar	4	アルミ押出材 A6063S-T5 Extruded aluminium A6063S-T5	シルバーアルマイト Silver・Anodized
5	取付用ローレットビス(M4 x 8) Knurled Thumb Screw(M4 - 8)	8	真ちゆう Brass	ニッケルメッキ Nickel plated
6	ゴム足 / Rubber feet	4	ポリウレタン / Polyurethane	透明 / Transparent

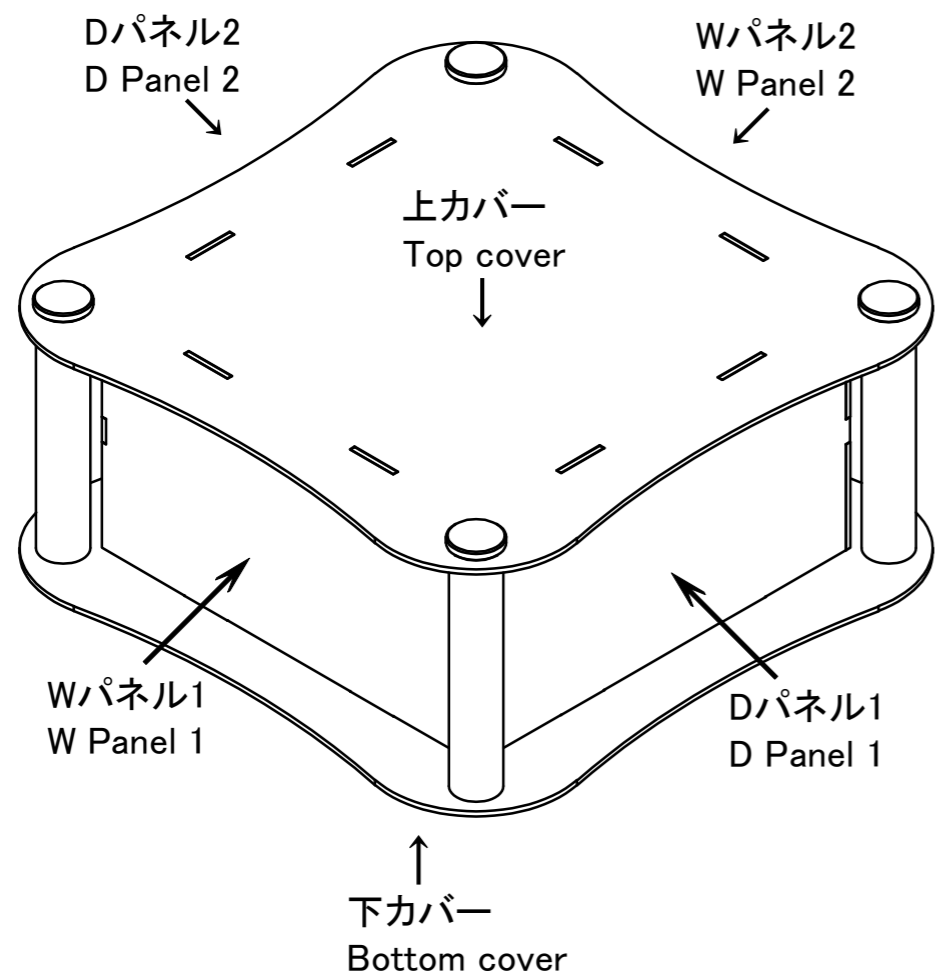

 *ゴム足は任意の位置に貼り付けできます。
 *Adhesive rubber feet in cluded

取付用ローレットビス / Knurled Thumb Screw

ゴム足 / Rubber feet

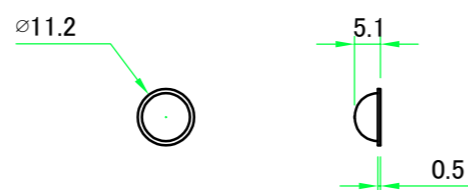
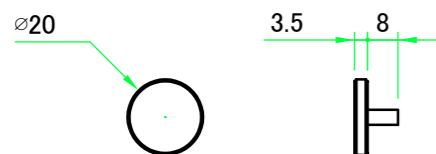

本図面および付帯する部品図の著作権は株式会社タカチ電機工業に帰属します。 / Copyright (C) TAKACHI ELECTRONICS ENCLOSURE CO., LTD. All Rights Reserved.

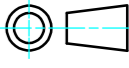
TAKACHI 株式会社タカチ電機工業 TAKACHI ELECTRONICS ENCLOSURE CO., LTD.			品名/Title 曲線型アルミケース ARC DESIGN ALUMINIUM CASE	 尺度/Scale 1:2.5
承認/Approved 中根	検図/Checked 横田	製図/Created 常山	型番/Product number ALR18-10-18	
			作成日/Date 2022/11/22	1 / 5

外視 / External View

Wパネル2 / W Panel 2

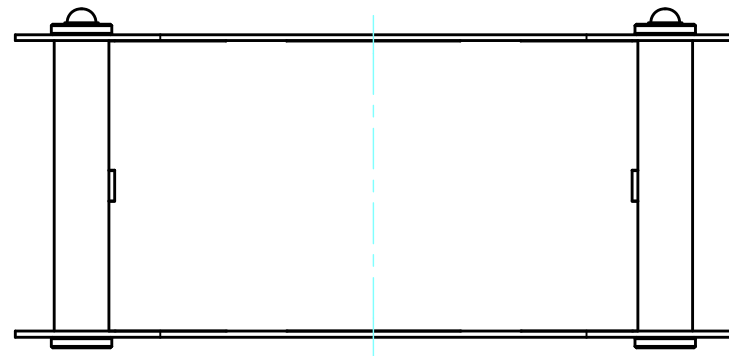

Dパネル2 / D Panel 2

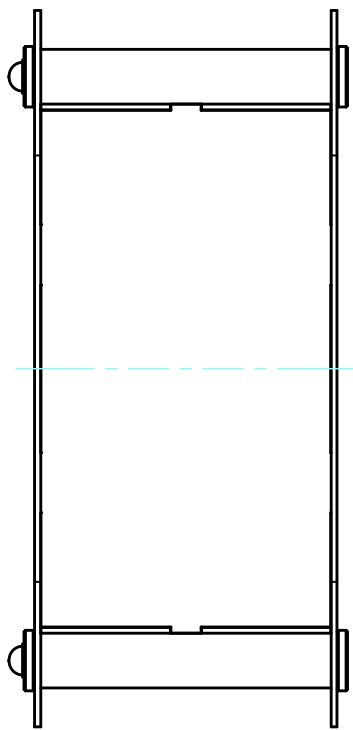

上カバー / Top cover

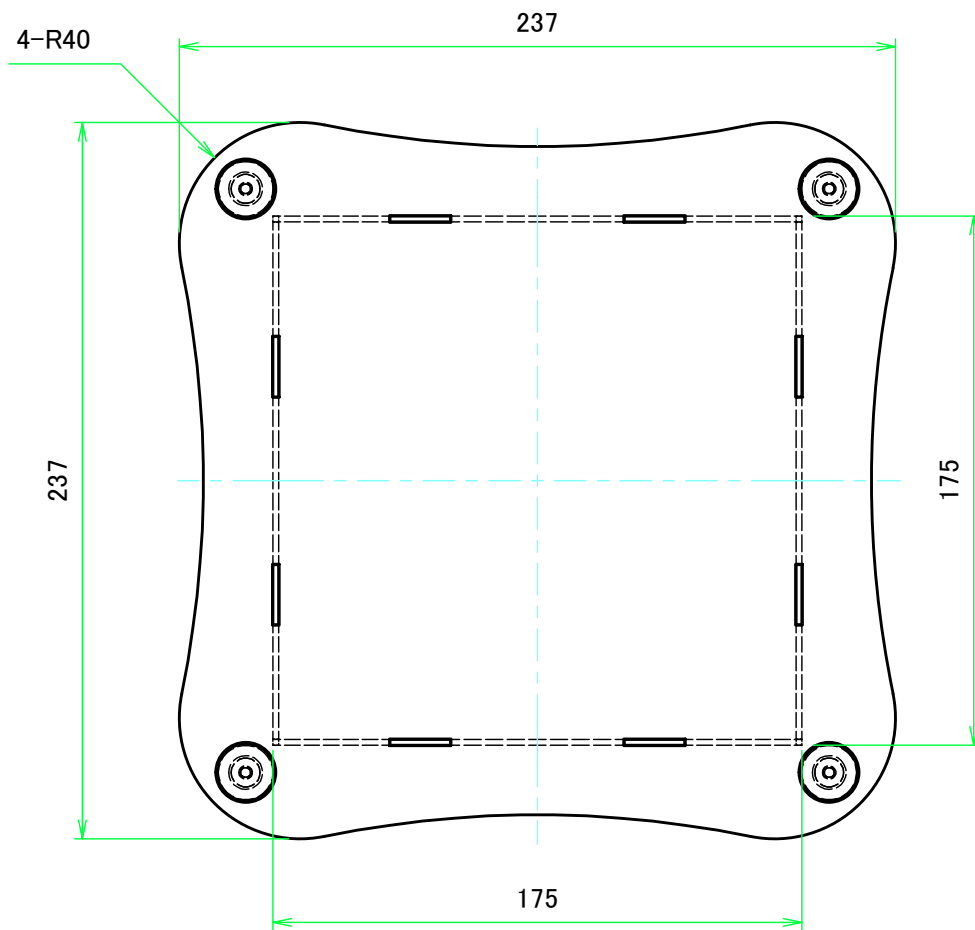

Dパネル1 / D Panel 1

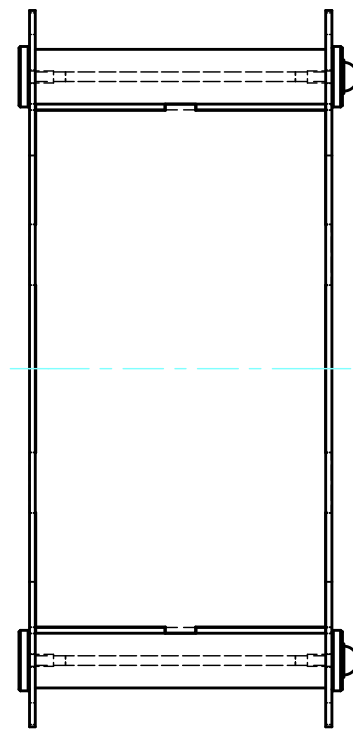

下カバー / Bottom cover

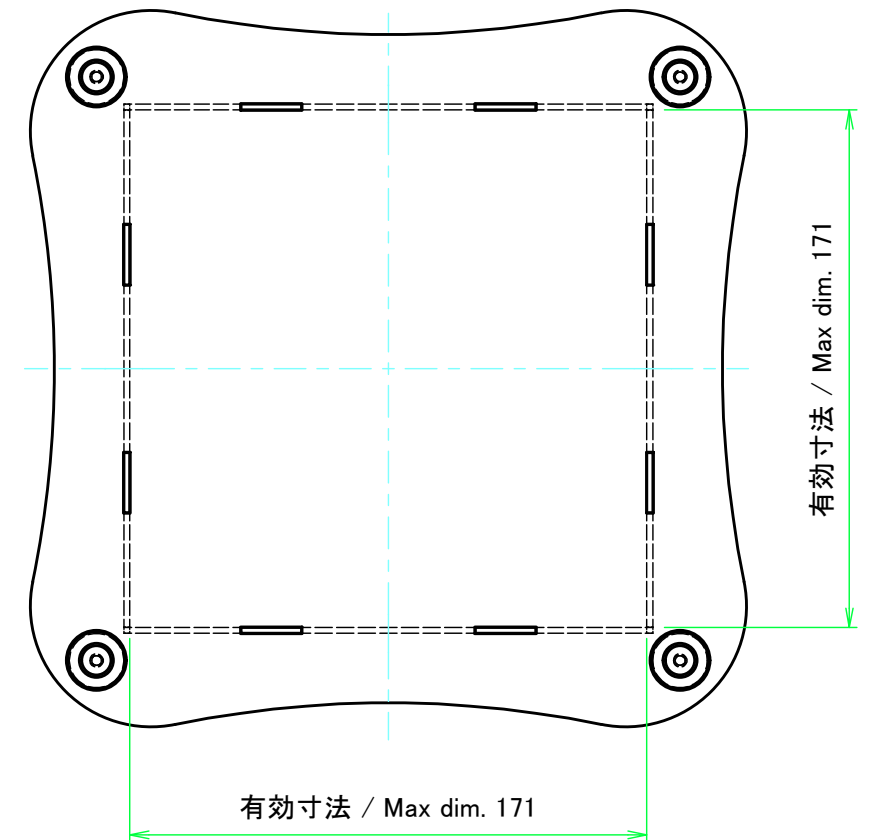

Wパネル1 / W Panel 1

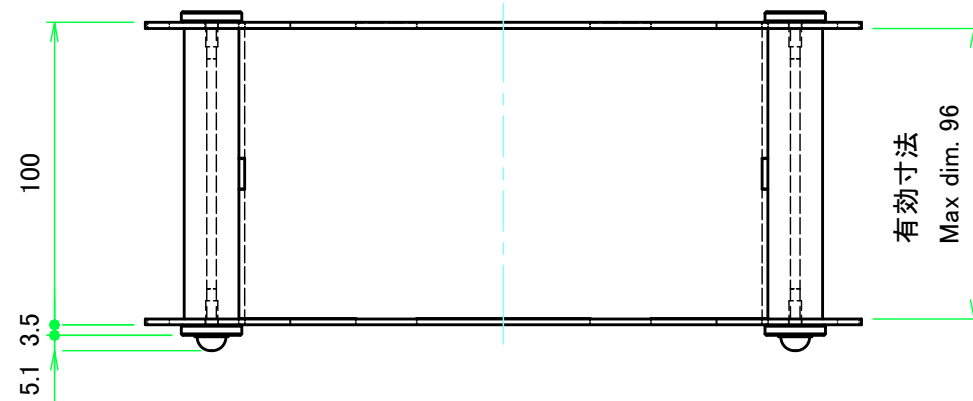

株式会社タカチ電機工業 TAKACHI ELECTRONICS ENCLOSURE CO., LTD.			品名/Title 曲線型アルミケース ARC DESIGN ALUMINIUM CASE	尺度/Scale 1:2.5
承認/Approved	検図/Checked	製図/Created	型番/Product number ALR18-10-18	
中根	横田	常山	作成日/Date 2020/10/20	2 / 5

上下カバー / Top and Bottom cover

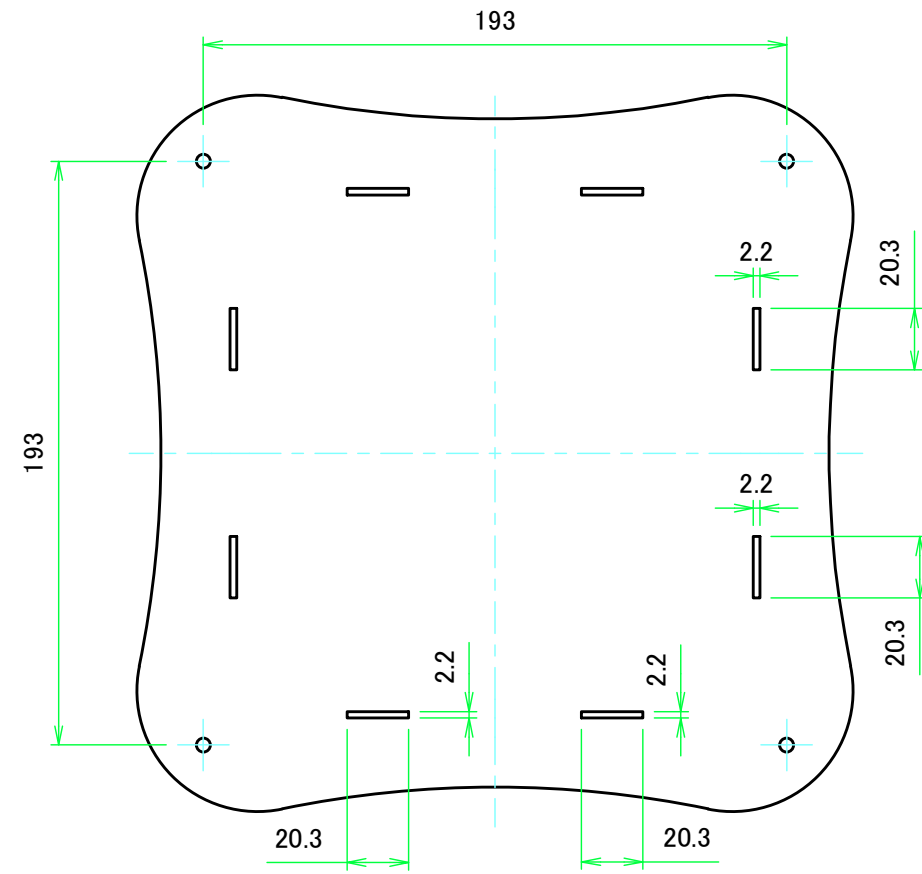
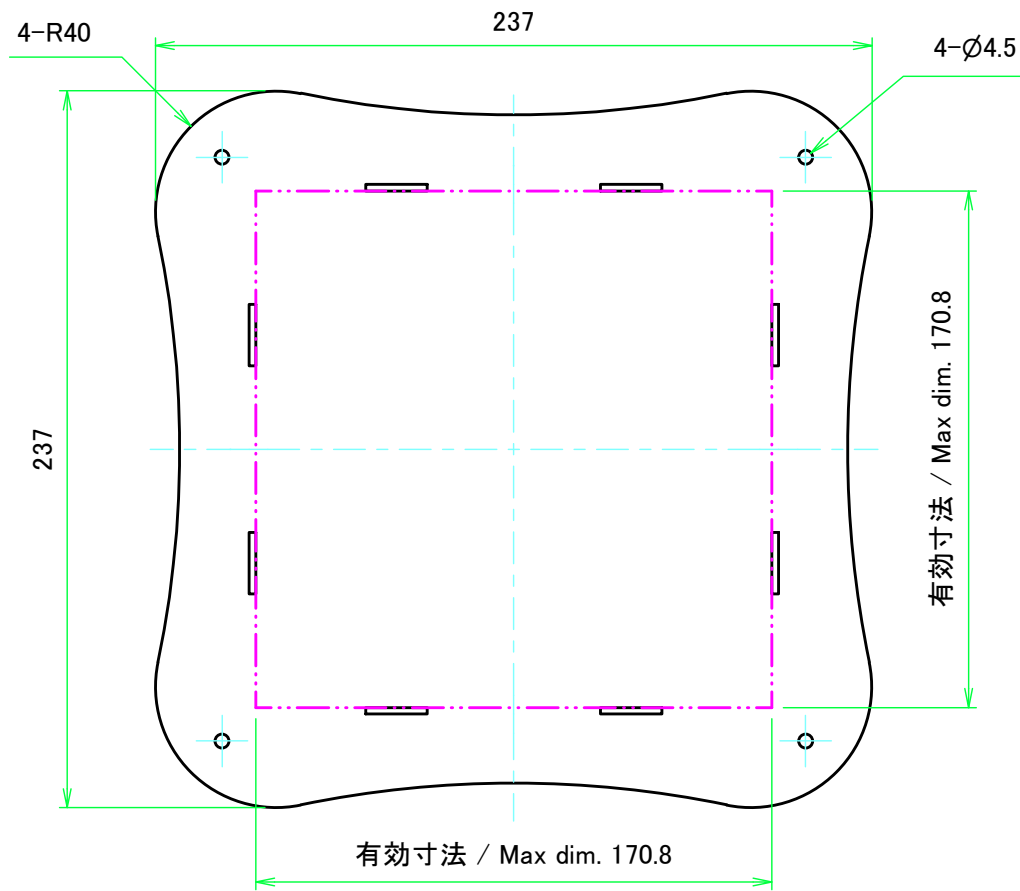

上カバー表面 / Top cover Frontside

上カバー裏面 / Top cover Backside

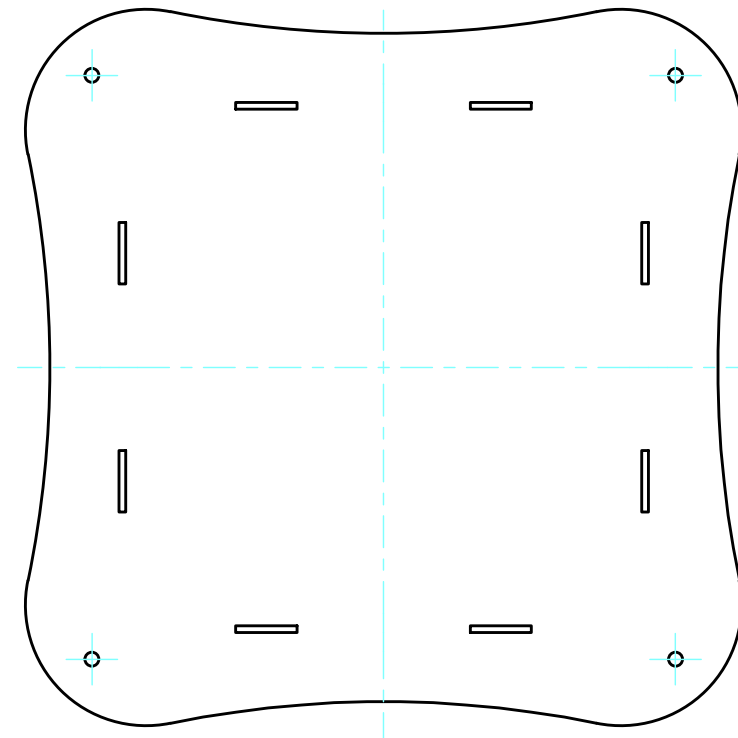
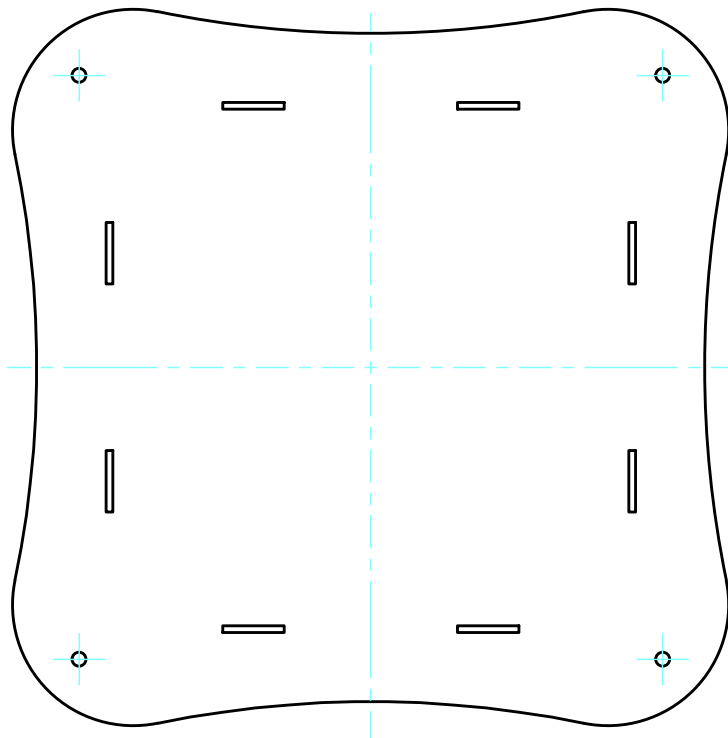

下カバー表面 / Bottom cover Frontside

下カバー裏面 / Bottom cover Backside

株式会社タカチ電機工業 TAKACHI ELECTRONICS ENCLOSURE CO., LTD.			品名/Title 曲線型アルミケース ARC DESIGN ALUMINIUM CASE	尺度/Scale 1:2.5
承認/Approved	検図/Checked	製図/Created	型番/Product number ALR18-10-18	
中根	横田	常山	作成日/Date 2020/10/20	3 / 5

Wパネル / W Panel

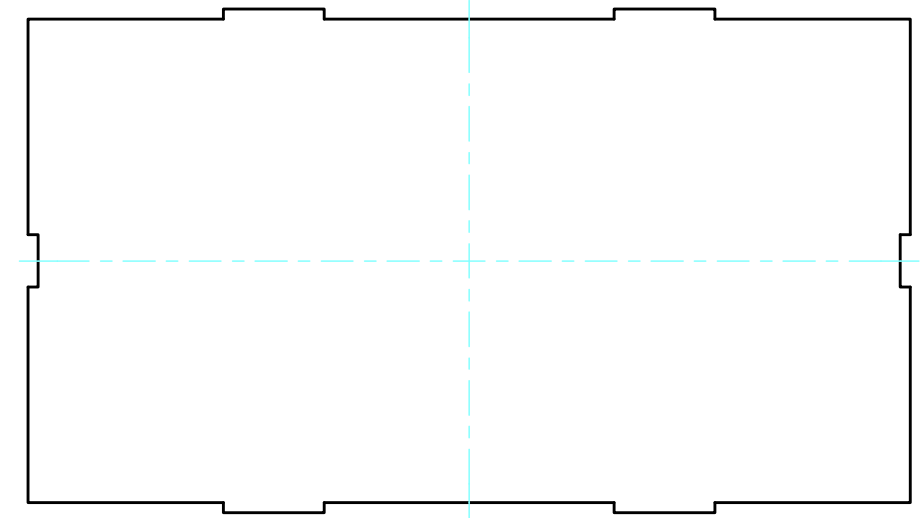
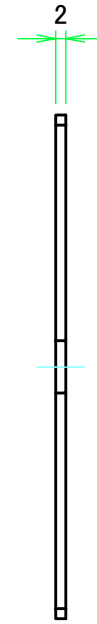
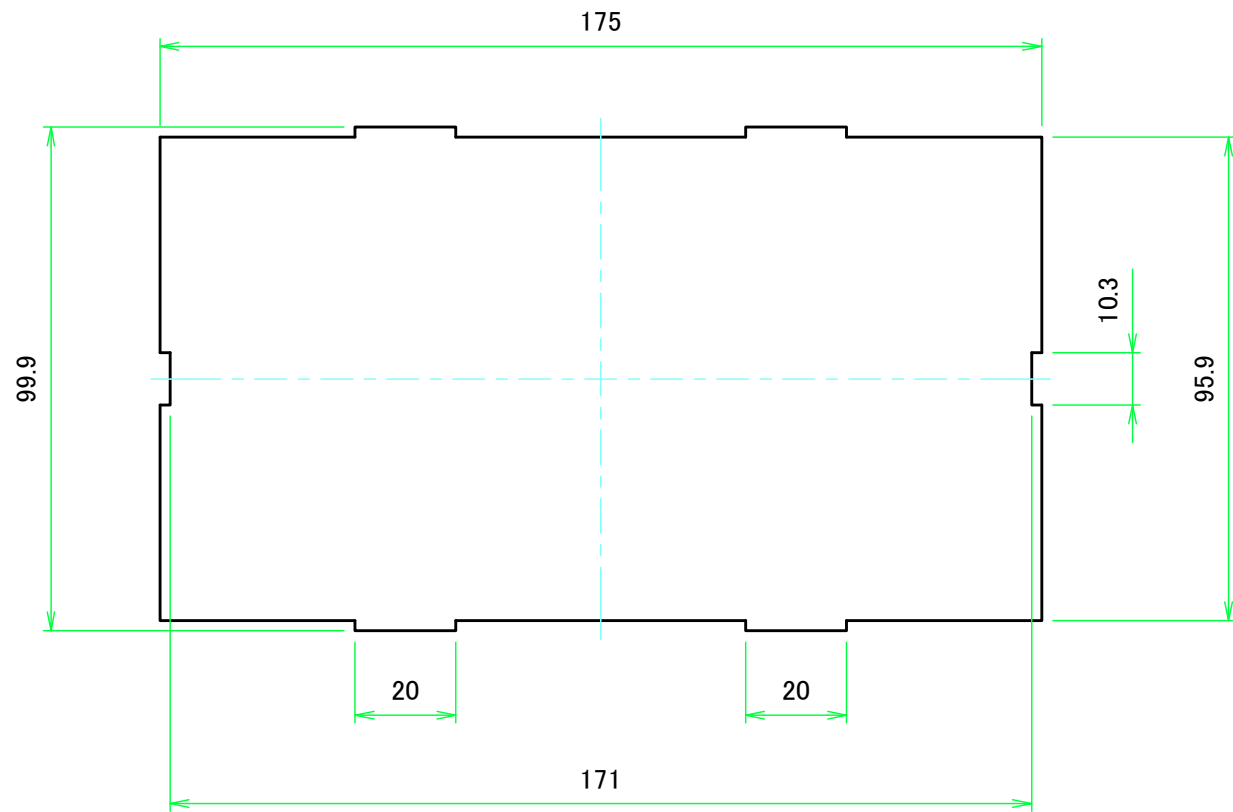

Wパネル1表面 / W Panel 1 Frontside

Wパネル1裏面 / W Panel 1 Backside

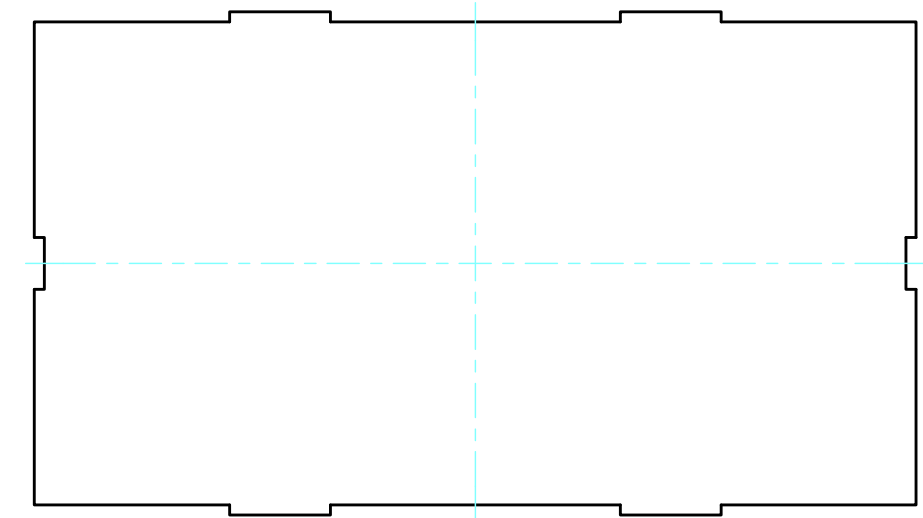
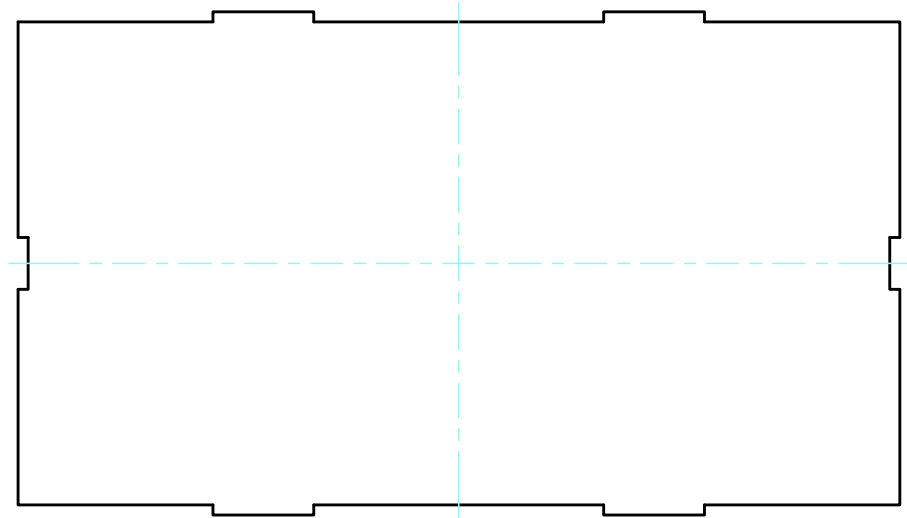

Wパネル2表面 / W Panel 2 Frontside

Wパネル2裏面 / W Panel 2 Backside

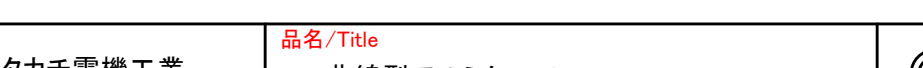

株式会社タカチ電機工業 TAKACHI ELECTRONICS ENCLOSURE CO., LTD.			品名/Title 曲線型アルミケース ARC DESIGN ALUMINIUM CASE	尺度/Scale 1:1.5
承認/Approved	検図/Checked	製図/Created	型番/Product number ALR18-10-18	
中根	横田	常山	作成日/Date 2020/10/20	4 / 5

Dパネル / D Panel

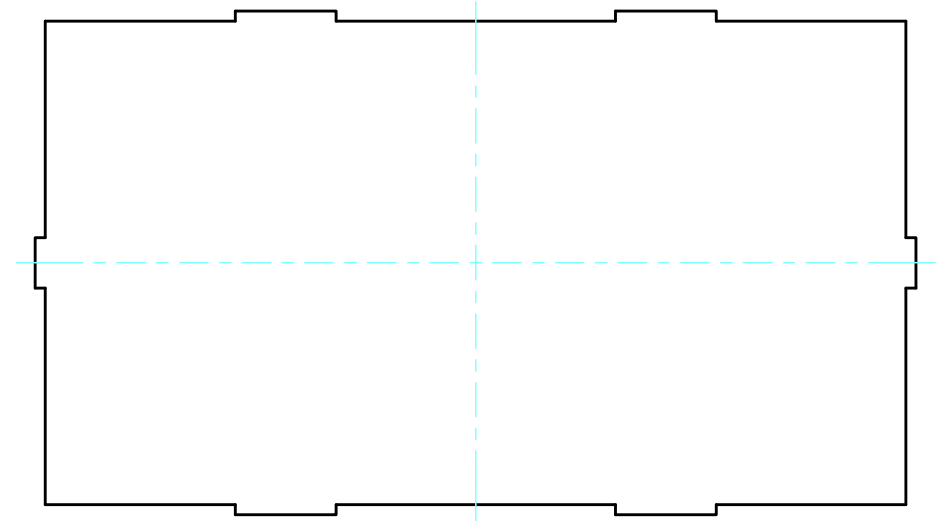
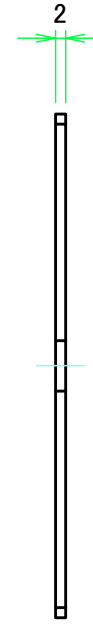
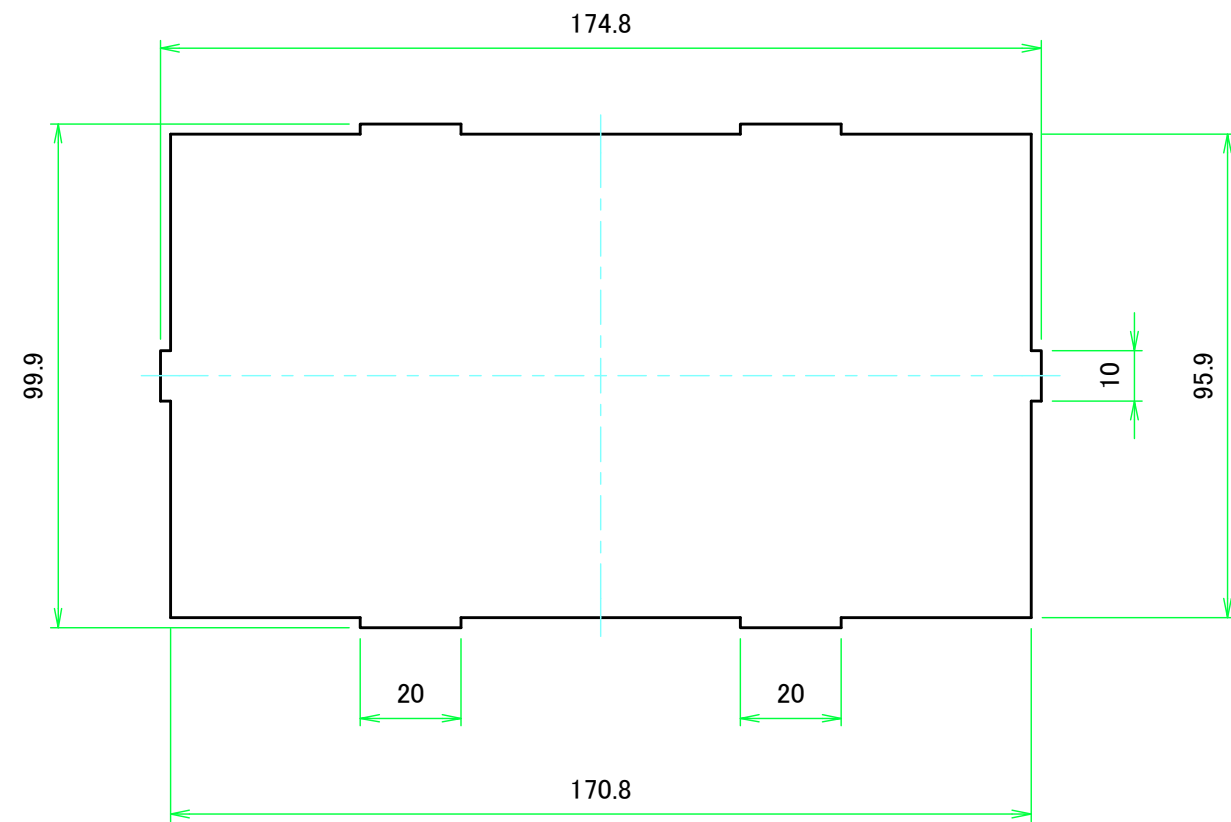

Dパネル1表面 / D Panel 1 Frontside

Dパネル1裏面 / D Panel 1 Backside

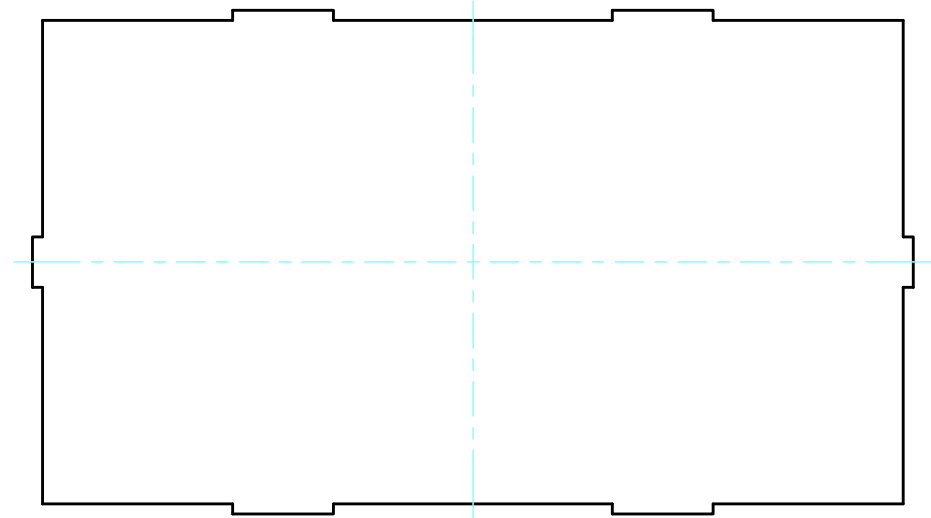
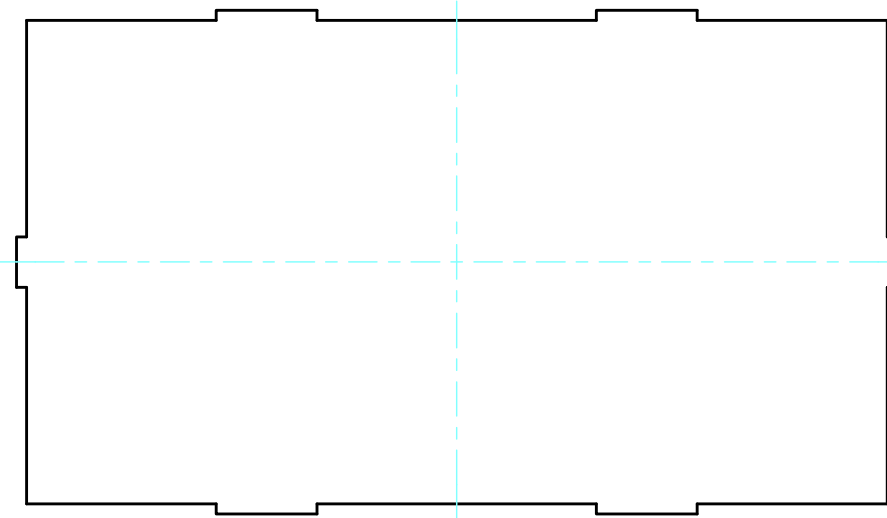

Dパネル2表面 / D Panel 2 Frontside

Dパネル2裏面 / D Panel 2 Backside

株式会社タカチ電機工業 TAKACHI ELECTRONICS ENCLOSURE CO., LTD.		品名/Title 曲線型アルミケース ARC DESIGN ALUMINIUM CASE	尺度/Scale 1:1.5
承認/Approved	検図/Checked	製図/Created	
中根	横田	常山	作成日/Date 2020/10/20
			5 / 5