

■テクニカルデータ / Technical Data■
 締付トルク / Recommended torque
 M2.5 : 0.15N・m ~ 0.2N・m
 M3、M4 : 0.3N・m ~ 0.6N・m

構成内容 / Components				
No.	名称 / Part name	数量 / Pcs	材質 / Material	色・表面処理 / Color・Finish
1	コーナーブロック Corner block	4	アルミダイキャスト ADC12 Diecast aluminium ADC12	シルバー、ブラック・塗装 (内部無処理) Silver, Black・Painted (Unfinished inside)
2	側板 Frame	2	アルミ押出材 A6063S-T5 Extruded aluminium A6063S-T5	シルバー・塗装 (内部無処理) Silver・Painted (Unfinished inside)
3	フレーム Panel support frame	4	アルミ押出材 A6063S-T5 Extruded aluminium A6063S-T5	シルバー・塗装 (内部無処理) Silver・Painted (Unfinished inside)
4	パネル Panel	2	アルミ板 A1100P Aluminium A1100P	シルバー・塗装 (裏面導通処理) Silver・Painted (Conductive inside)
5	カバー Top cover	1	アルミ板 A1100P Aluminium A1100P	シルバー・塗装 (裏面導通処理) Silver・Painted (Conductive inside)
6	下カバー Bottom cover	1	アルミ板 A1100P Aluminium A1100P	シルバー・塗装 (裏面導通処理) Silver・Painted (Conductive inside)
7	ゴム足 Ruber feet アルミ足 Aluminium feet	4	TPE (エラストマ) TPE (Elastomer) アルミ & シリコンゴム Aluminium & Silicone	ブラック Black シルバー・アルマイト & ブラック Silver・Anodized & Black
8	取付ビス (皿M3 x 8) Screw (Flat head M3 - 8)	16	鉄 Steel	ニッケルメッキ Nickel plated
9	取付ビス (台形M3 x 5) Screw (Trapezoid head M3 - 5)	12	鉄 Steel	ニッケルメッキ Nickel plated
10	取付ビス (バインドM4 x 8) Screw (Bind head M4 - 8)	4	鉄 Steel	三価黒クロメート Black trivalent chromate
11	取付ビス (落下防止ナベM2.5 x 7) Screw (Captive pan head M2.5 - 7)	8	鉄 Steel	ニッケルメッキ Nickel plated

型番 / Product Number

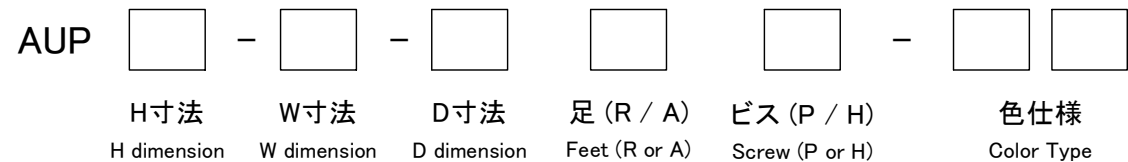

足仕様 / Feet specification

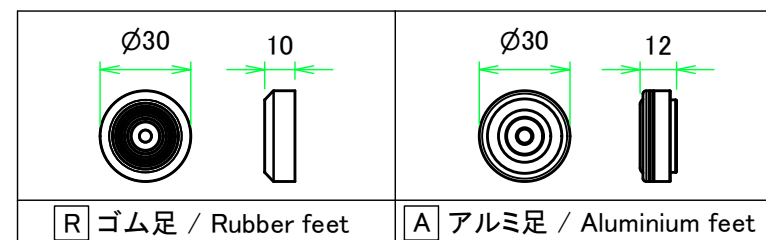

台形ビス仕様 / Original trapezoid head screw specification

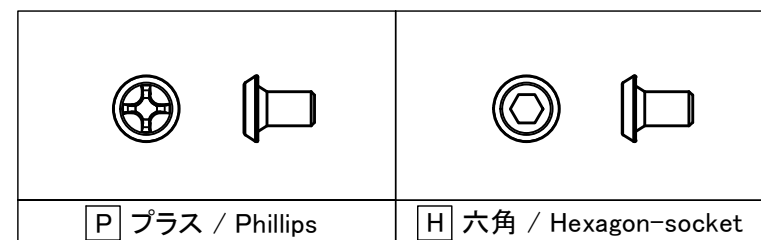

色仕様 / Color Type

記号 / Code	コーナーブロック / Corner block	側板 / Frame	パネル / Panel	カバー / Top cover	下カバー / Bottom cover
S S	シルバー / Silver	シルバー / Silver	シルバー / Silver	シルバー / Silver	シルバー / Silver
S B	ブラック / Black	シルバー / Silver	シルバー / Silver	シルバー / Silver	シルバー / Silver

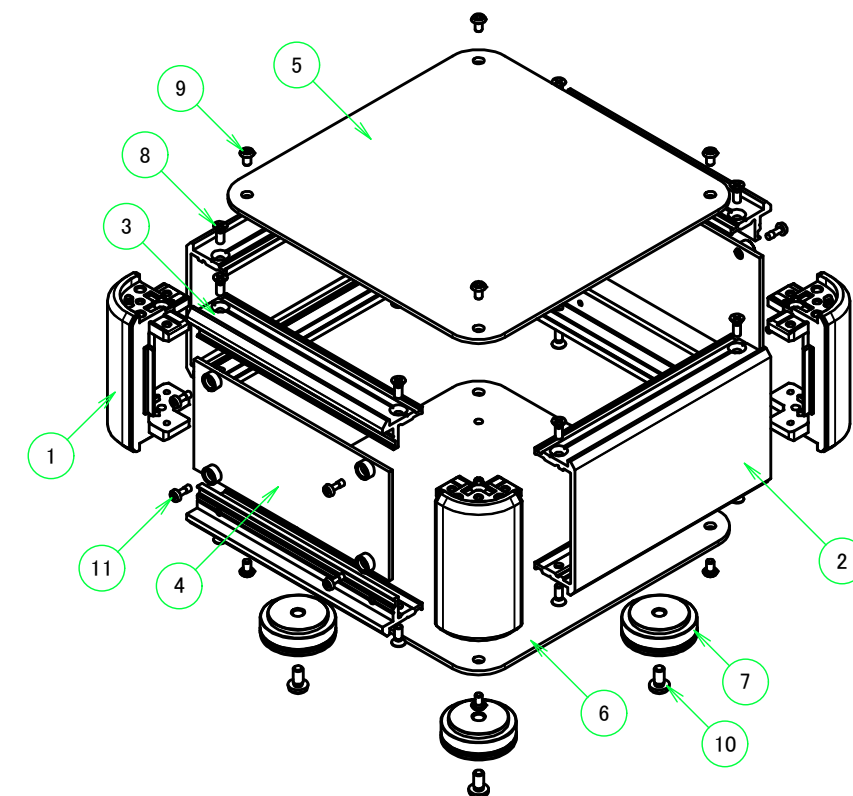

本図面および付帯する部品図の著作権は株式会社タカチ電機工業に帰属します。 / Copyright (C) TAKACHI ELECTRONICS ENCLOSURE CO., LTD. All Rights Reserved.

TAKACHI 株式会社タカチ電機工業 TAKACHI ELECTRONICS ENCLOSURE CO., LTD.			品名 / Title パネル脱着アルミサッシケース ALUMINIUM ENCLOSURE with DETACHABLE PANELS	
承認 / Approved 中根	検図 / Checked 王	製図 / Created 常山	型番 / Product number AUP66-30-43□□-□□	尺度 / Scale
作成日 / Date 2022/10/07			ページ / Page 1 / 7	

B-B (1:5.5)

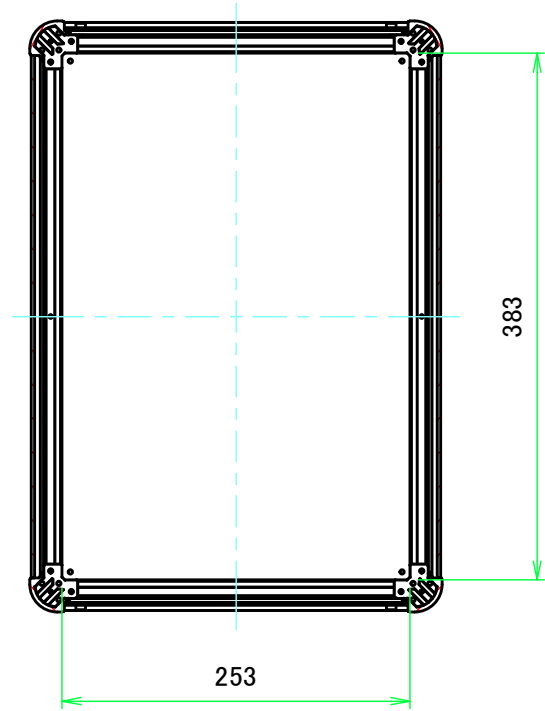

E view

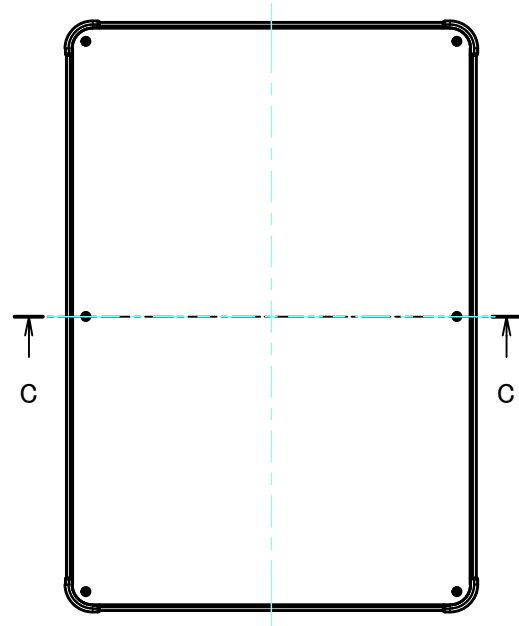

A-A (1:5.5)

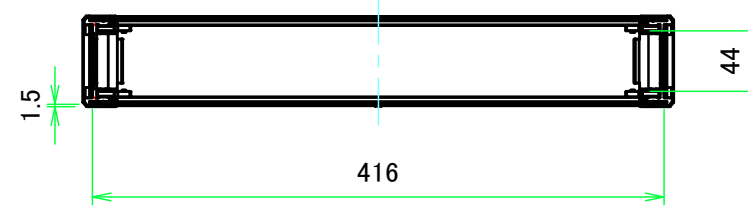

C-C (1:5.5)

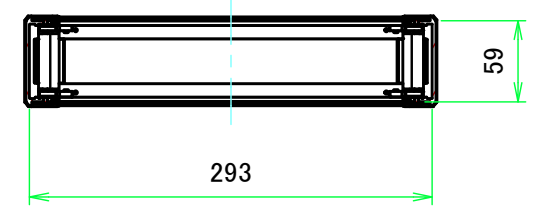

D view



A view

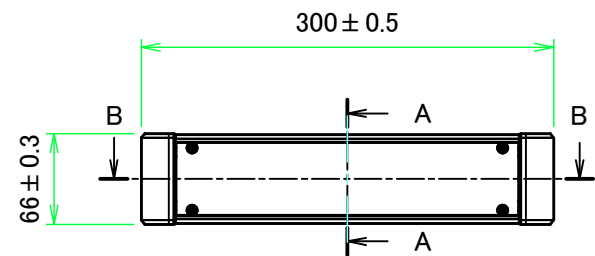

C view

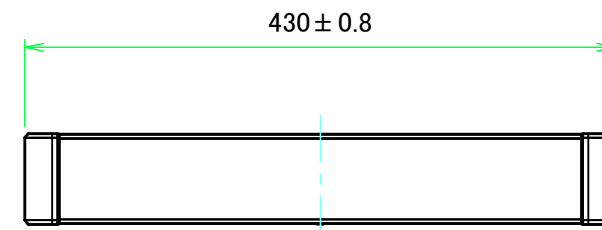

B view



F view

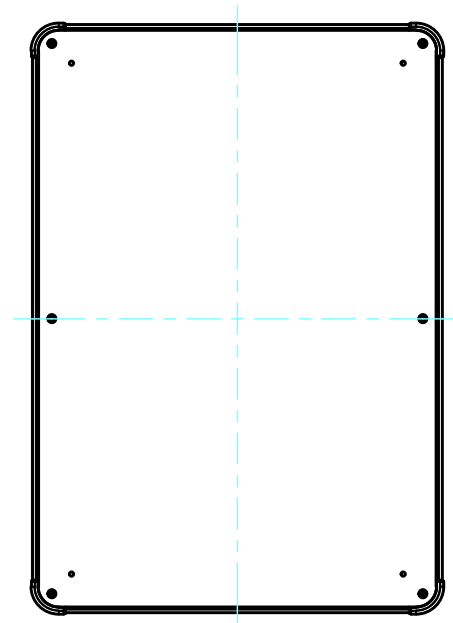

株式会社タカチ電機工業 <small>TAKACHI ELECTRONICS ENCLOSURE CO., LTD.</small>			品名/Title パネル脱着アルミサッシケース ALUMINIUM ENCLOSURE with DETACHABLE PANELS	尺度/Scale 1:5.5
承認/Approved	検図/Checked	製図/Created	型番/Product number AUP66-30-43□□-□□	
中根	王	常山	作成日/Date 2022/10/11	ページ/Page 2 / 7

C 側板 / C Frame

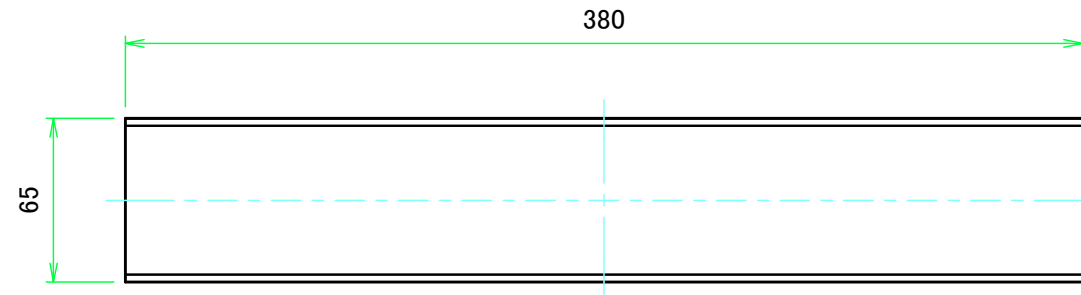
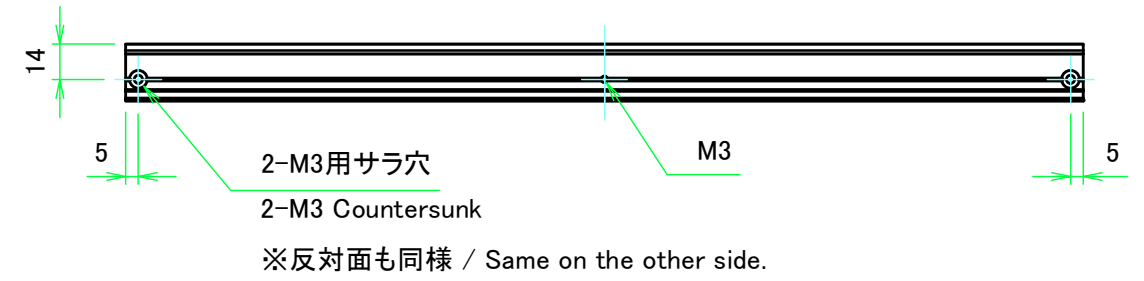

表面 / Front side

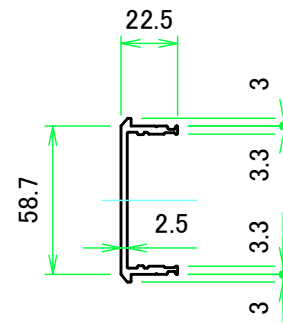

裏面 / Back side

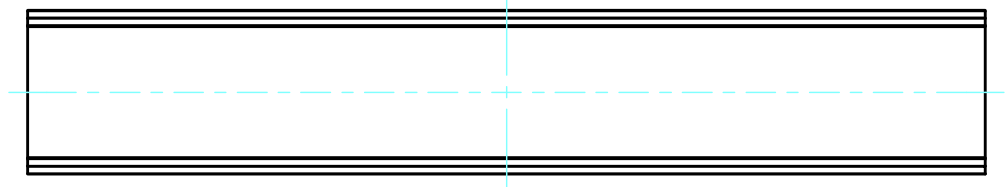

D 側板 / D Frame

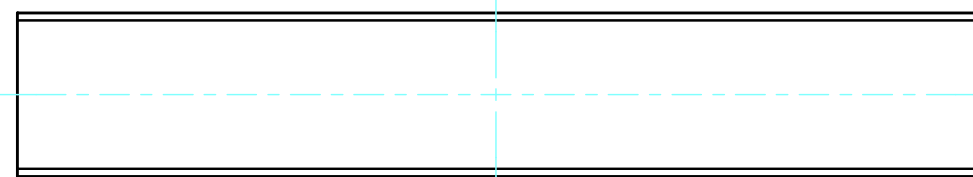

表面 / Front side



裏面 / Back side

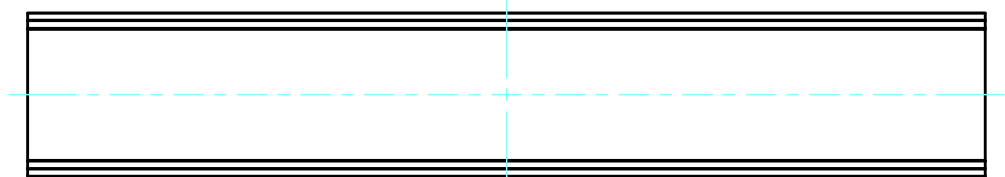

株式会社タカチ電機工業 TAKACHI ELECTRONICS ENCLOSURE CO., LTD.			品名/Title 側板 Frame	尺度/Scale 1:3
承認/Approved	検図/Checked	製図/Created	型番/Product number H66 - D430	
中根	王	常山	作成日/Date 2022/09/27	ページ/Page 3 / 7

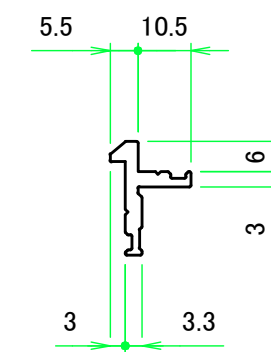
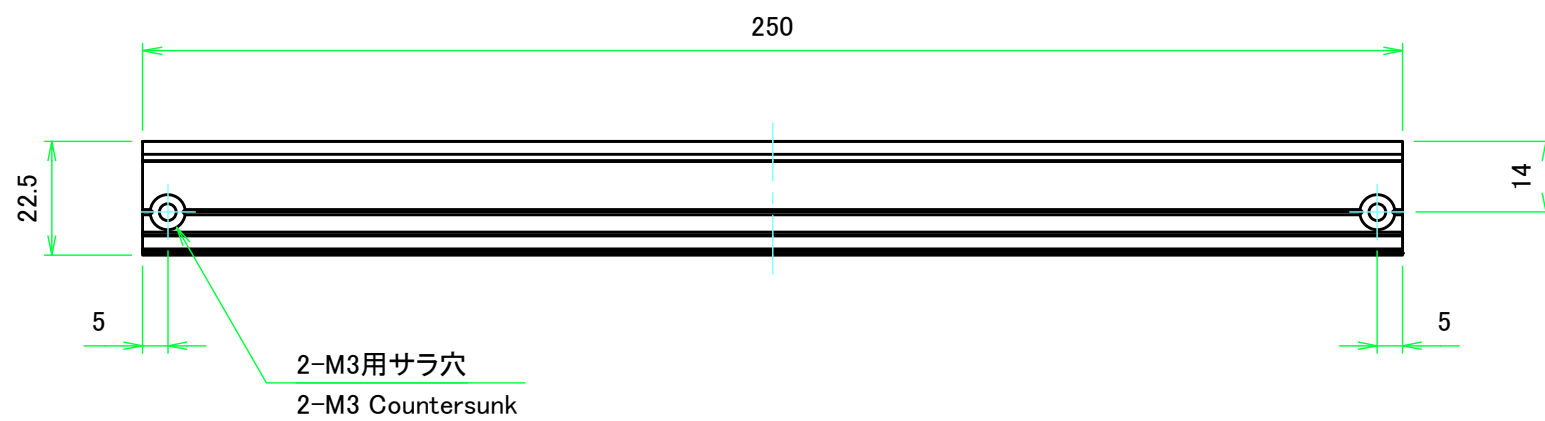
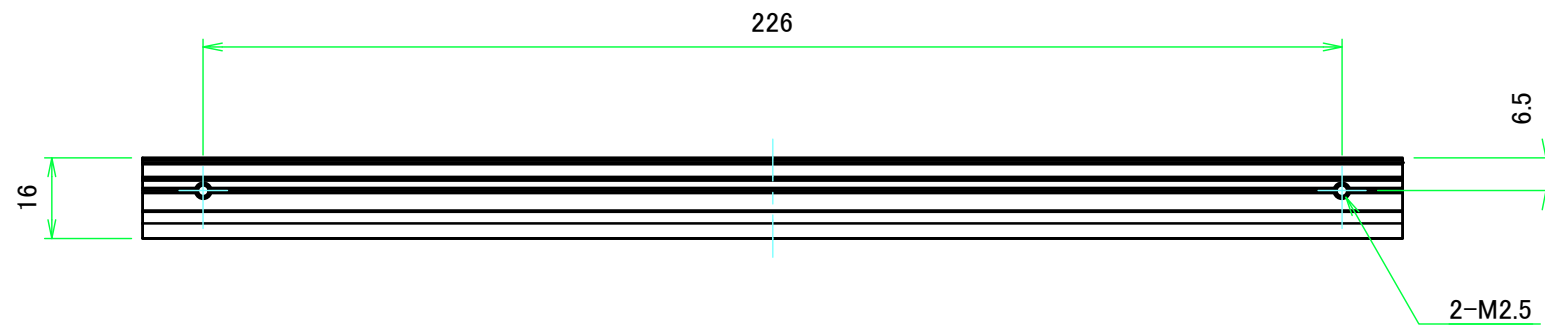

計4本 / Total 4 pieces

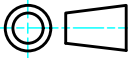
 株式会社タカチ電機工業 <small>TAKACHI ELECTRONICS ENCLOSURE CO., LTD.</small>			品名/Title フレーム Panel support frame	
承認/Approved	検図/Checked	製図/Created	型番/Product number	尺度/Scale
中根	王	野村	W300	1:1.5
			作成日/Date 2022/08/08	ページ/Page 4 / 7

A パネル / A Panel

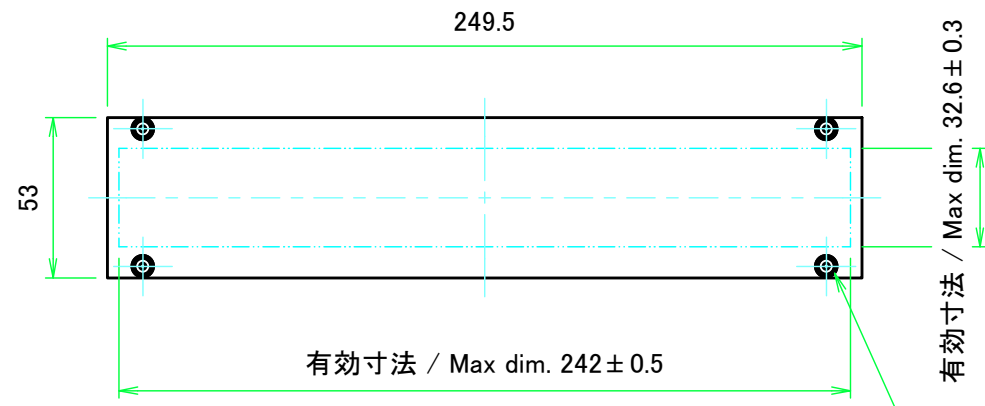

4-M2.5用メタルスリーブ
4-Metal sleeve for M2.5

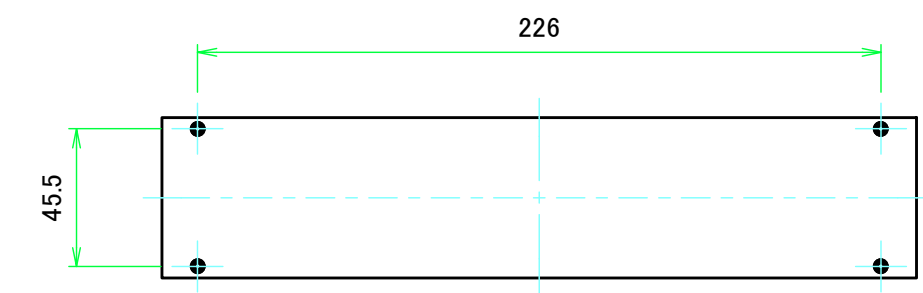
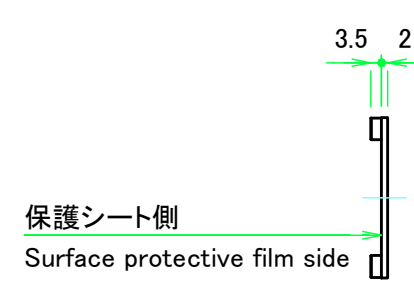

表面 / Front side

裏面 / Back side

B パネル / B Panel

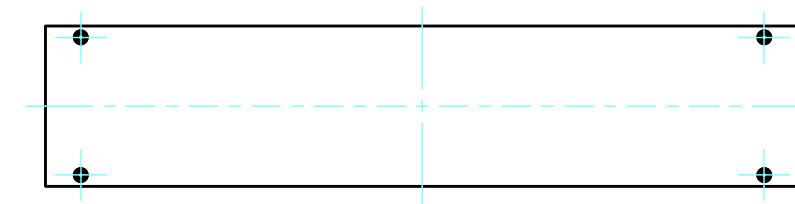
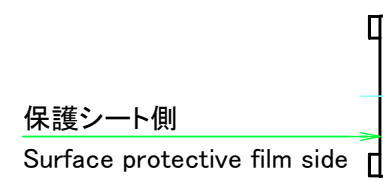
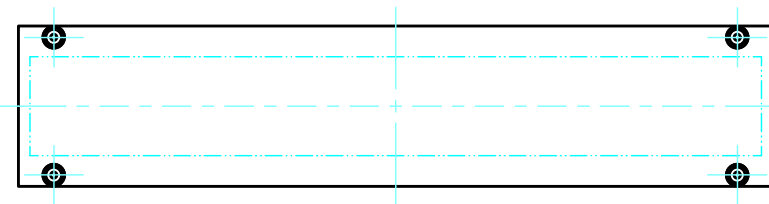

表面 / Front side

裏面 / Back side

株式会社タカチ電機工業 TAKACHI ELECTRONICS ENCLOSURE CO., LTD.			品名/Title パネル Panel	尺度/Scale 1:2.5
承認/Approved	検図/Checked	製図/Created	型番/Product number H66 - W300	
中根	王	常山	作成日/Date 2022/10/14	ページ/Page 5 / 7

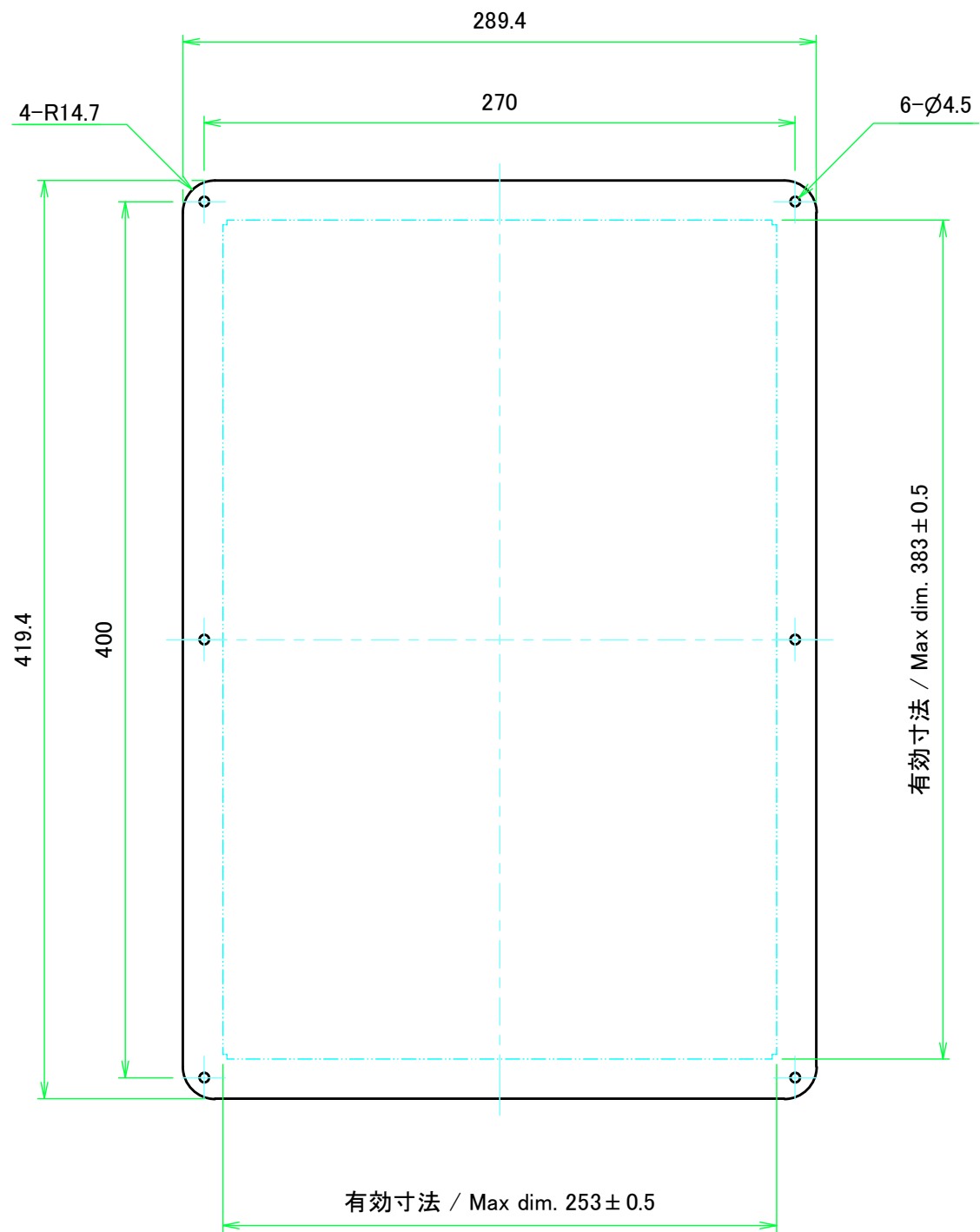

表面 / Front side

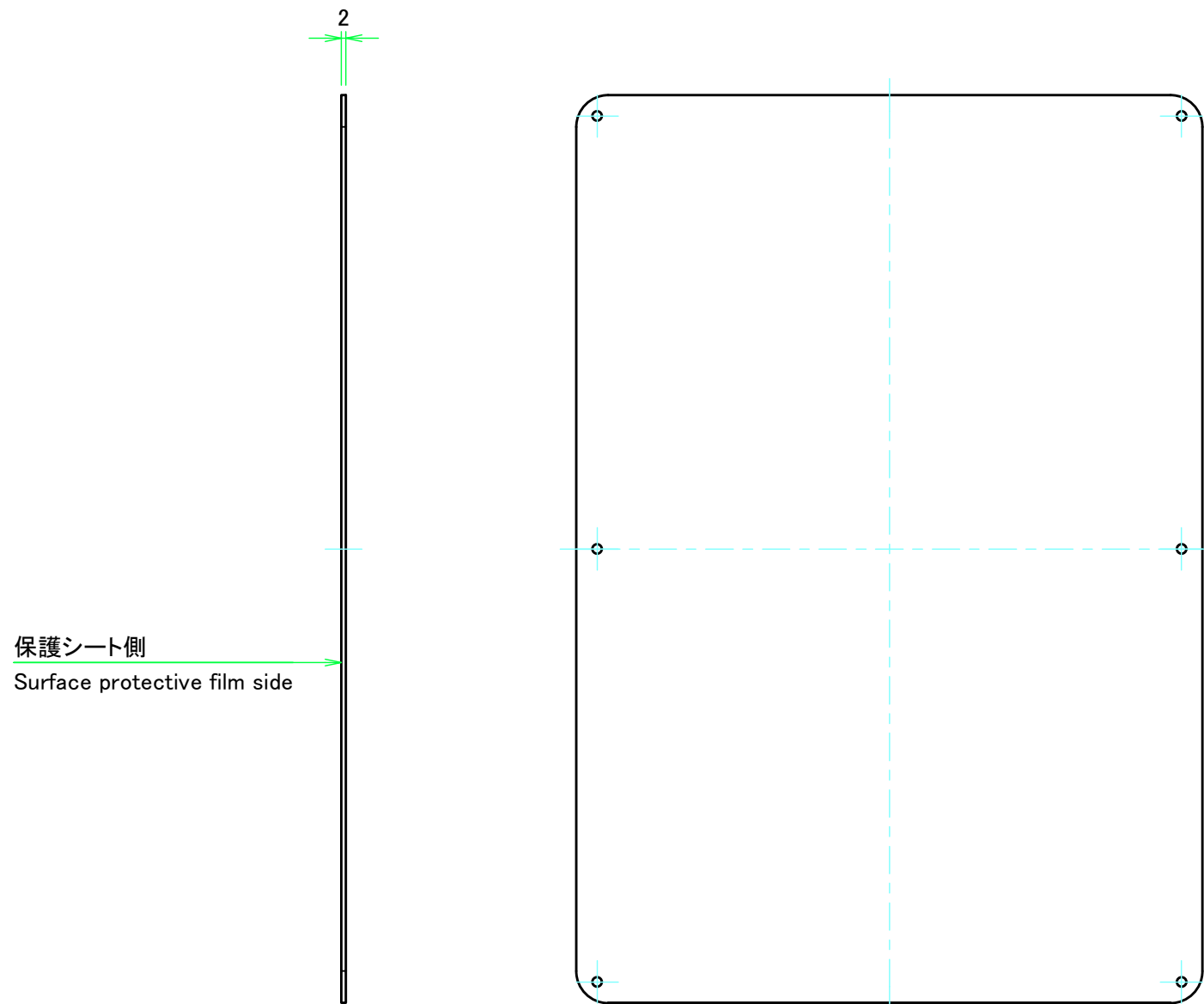

裏面 / Back side

 株式会社タカチ電機工業 <small>TAKACHI ELECTRONICS ENCLOSURE CO., LTD.</small>			品名/Title カバー Top cover	 尺度/Scale 1:3
承認/Approved	検図/Checked	製図/Created	型番/Product number W300 - D430	
中根	王	野村	作成日/Date 2022/07/20	ページ/Page 6 / 7

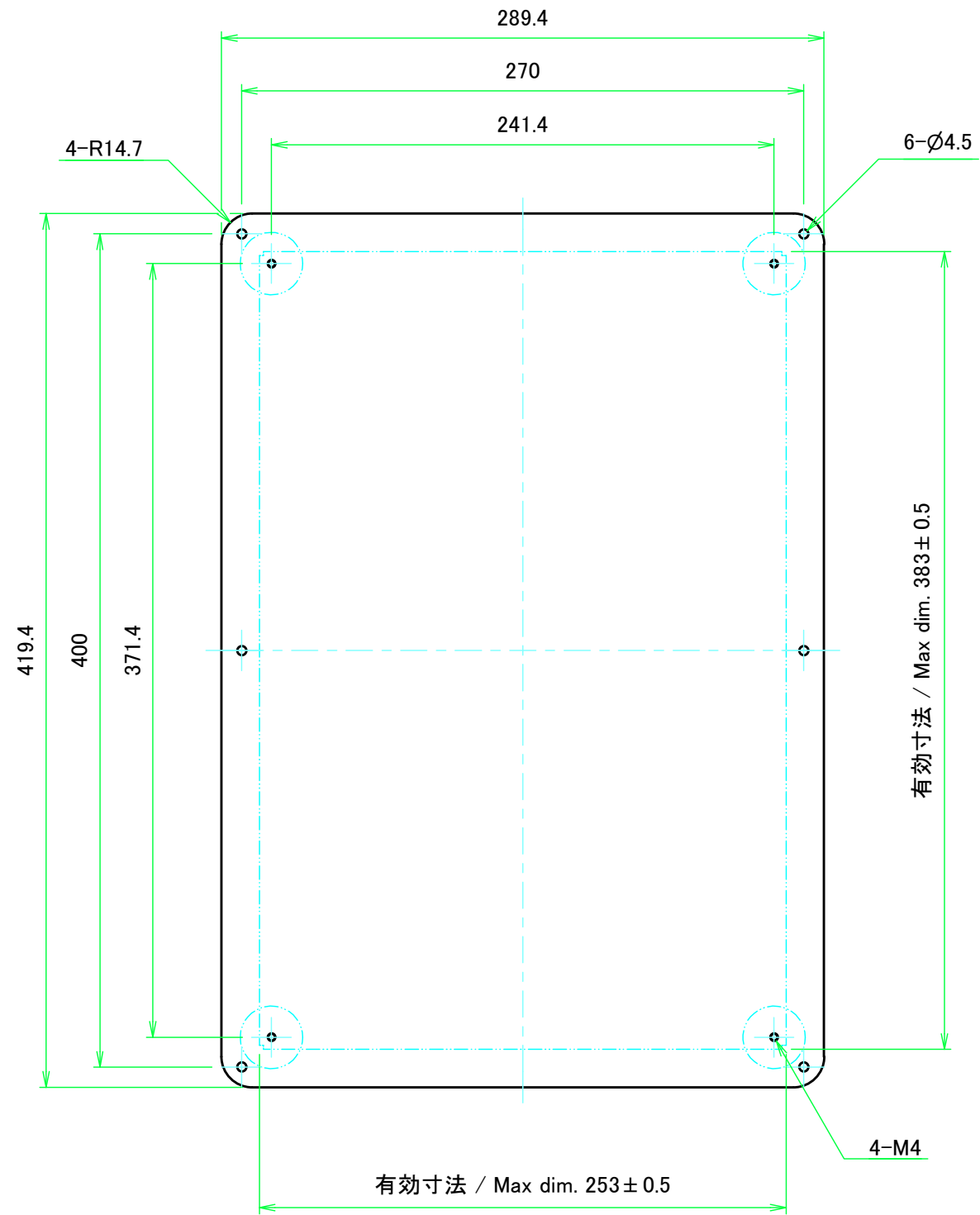

表面 / Front side

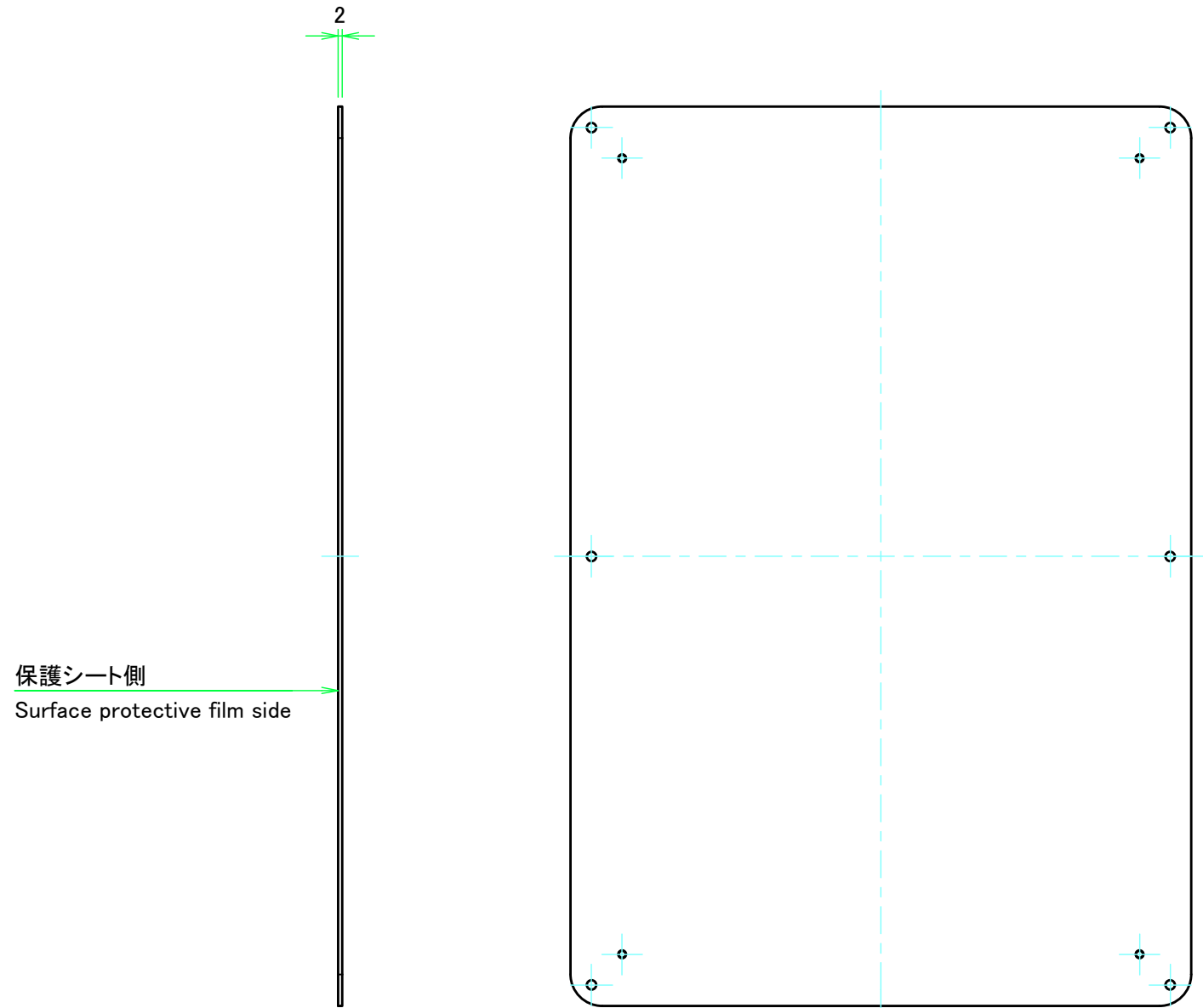

裏面 / Back side

 株式会社タカチ電機工業 <small>TAKACHI ELECTRONICS ENCLOSURE CO., LTD.</small>			品名/Title 下カバー Bottom cover	 尺度/Scale 1:3
承認/Approved	検図/Checked	製図/Created	型番/Product number W300 - D430	
中根	王	野村	作成日/Date 2022/07/20	ページ/Page 7 / 7