

B-B (1:5.5)

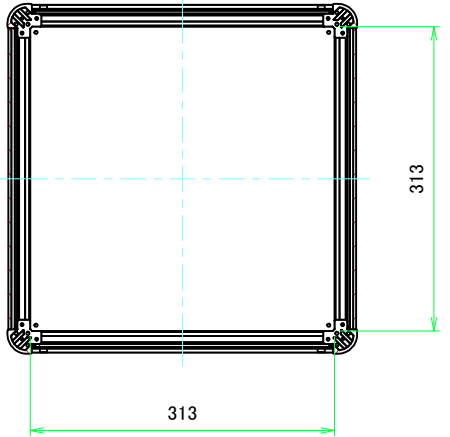

E view

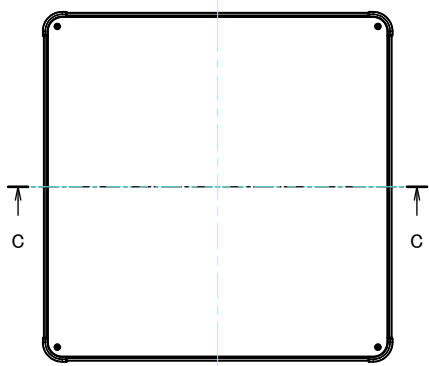

A-A (1:5.5)

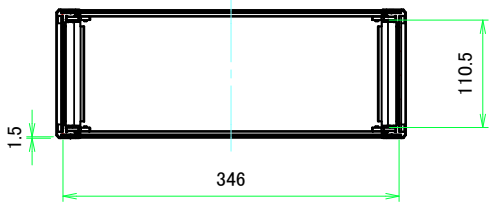

C-C (1:5.5)

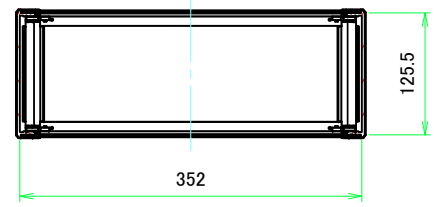

D view

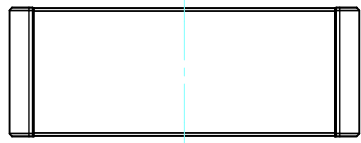

A view

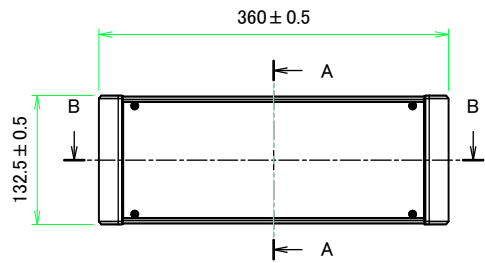

C view

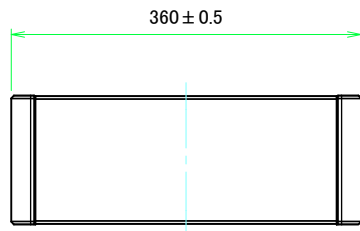

B view

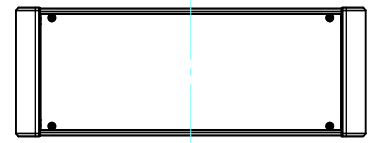

F view

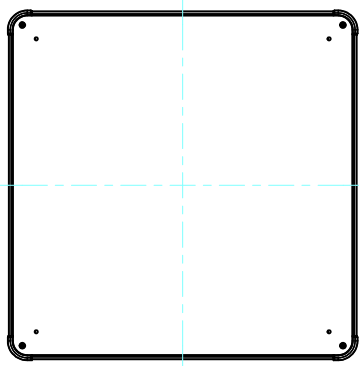

株式会社タカチ電機工業 TAKACHI ELECTRONICS ENCLOSURE CO., LTD.			品名/Title パネル脱着EMCシールドケース EMC SHIELDED ENCLOSURE with DETACHABLE PANELS	尺度/Scale 1:5.5
承認/Approved	検図/Checked	製図/Created	型番/Product number AUPE133-36-36□□-□□	
中根	王	野村	作成日/Date 2022/11/29	

C 側板 / C Frame

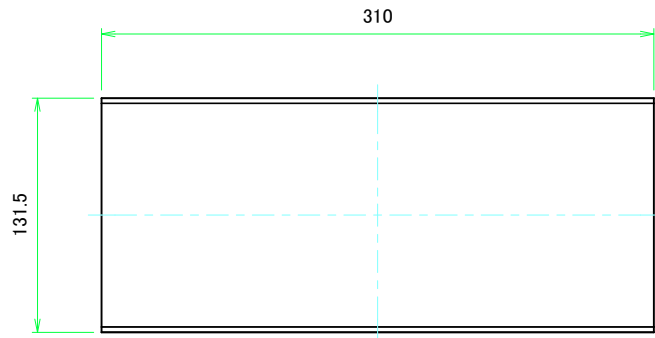

表面 / Front side

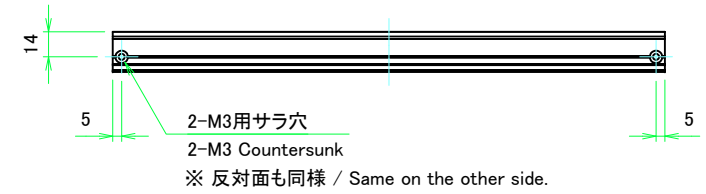
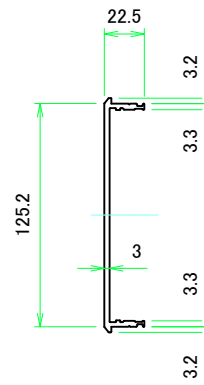

裏面 / Back side

D 側板 / D Frame

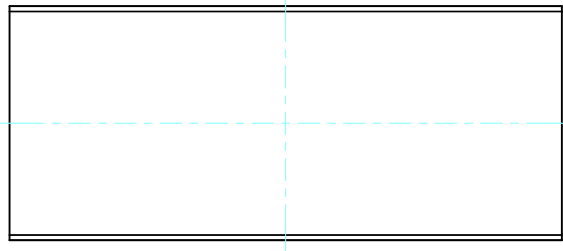

表面 / Front side



裏面 / Back side

株式会社タカチ電機工業 TAKACHI ELECTRONICS ENCLOSURE CO., LTD.			品名/Title 側板 Frame	尺度/Scale 1:3
承認/Approved 中根	検図/Checked 王	製図/Created 野村	型番/Product number	ページ/Page 3 / 7
H133 - D360			作成日/Date 2023/01/05	
本図面の著作権は株式会社タカチ電機工業に帰属します。 / Copyright (C) TAKACHI ELECTRONICS ENCLOSURE CO., LTD. All Rights Reserved.				

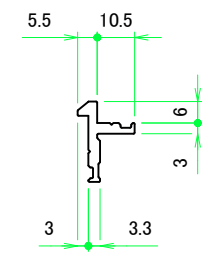
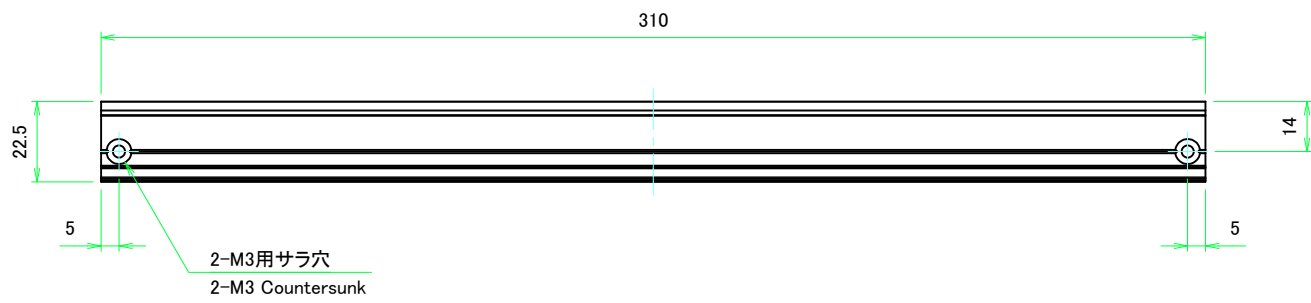
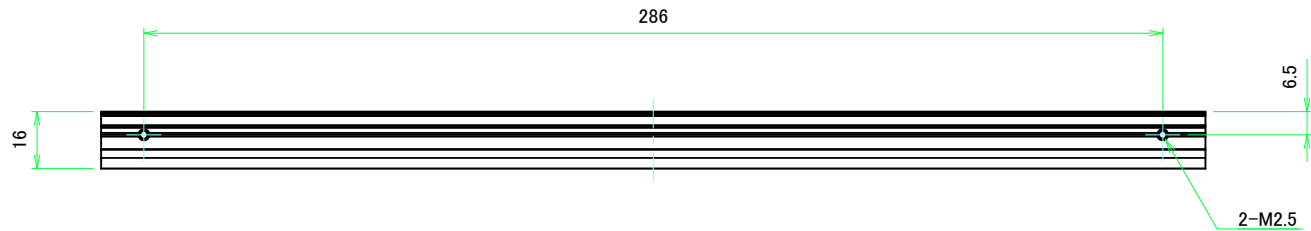

計4本 / Total 4 pieces

株式会社タカチ電機工業 <small>TAKACHI ELECTRONICS ENCLOSURE CO., LTD.</small>			品名/Title フレーム Panel support frame	尺度/Scale 1:1.5
承認/Approved 中根	検図/Checked 王	製図/Created 野村	型番/Product number W360	
			作成日/Date 2022/11/16	
<small>本図面の著作権は株式会社タカチ電機工業に帰属します。 / Copyright (C) TAKACHI ELECTRONICS ENCLOSURE CO., LTD. All Rights Reserved.</small>				

A パネル / A Panel

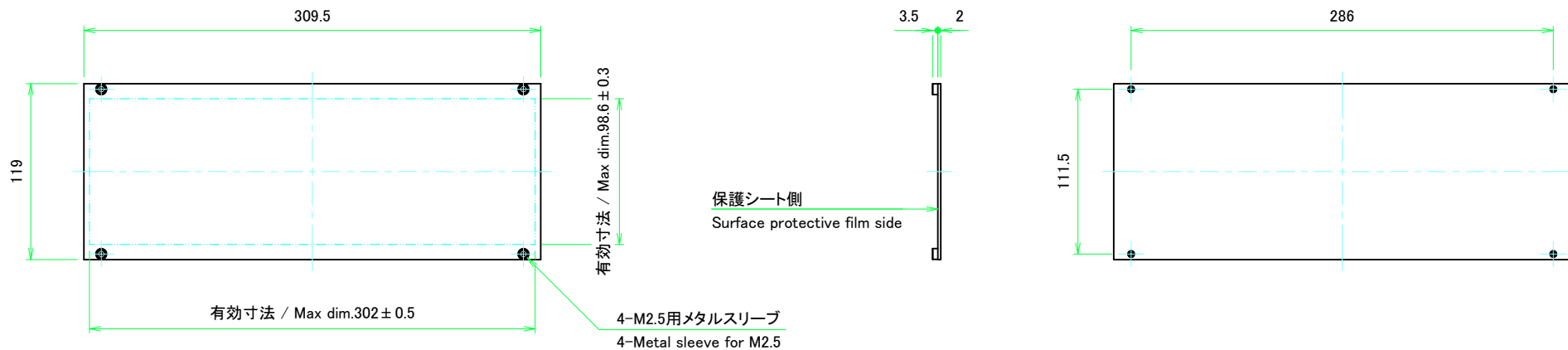

表面 / Front side

裏面 / Back side

B パネル / B Panel

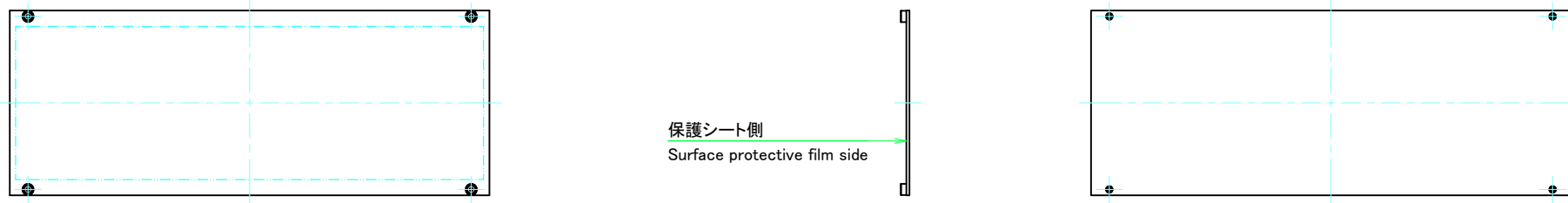

表面 / Front side

裏面 / Back side

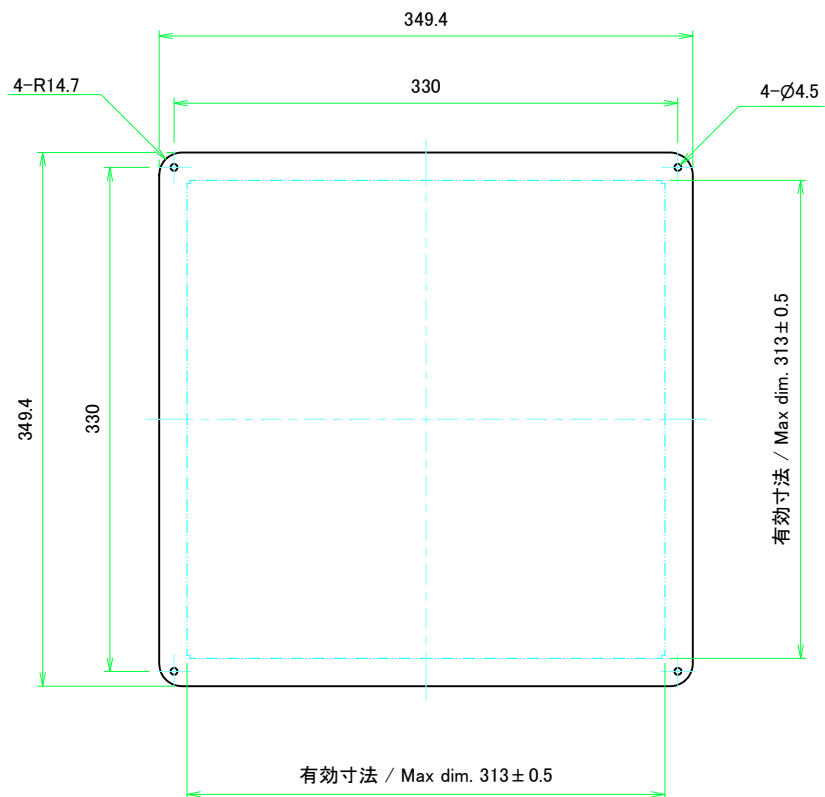

株式会社タカチ電機工業 <small>TAKACHI ELECTRONICS ENCLOSURE CO., LTD.</small>			品名/Title パネル Panel	尺度/Scale 1:3
承認/Approved 中根	検図/Checked 王	製図/Created 野村	型番/Product number H133 - W360	
			作成日/Date 2022/11/16	
本図面の著作権は株式会社タカチ電機工業に帰属します。 / Copyright (C) TAKACHI ELECTRONICS ENCLOSURE CO., LTD. All Rights Reserved.				

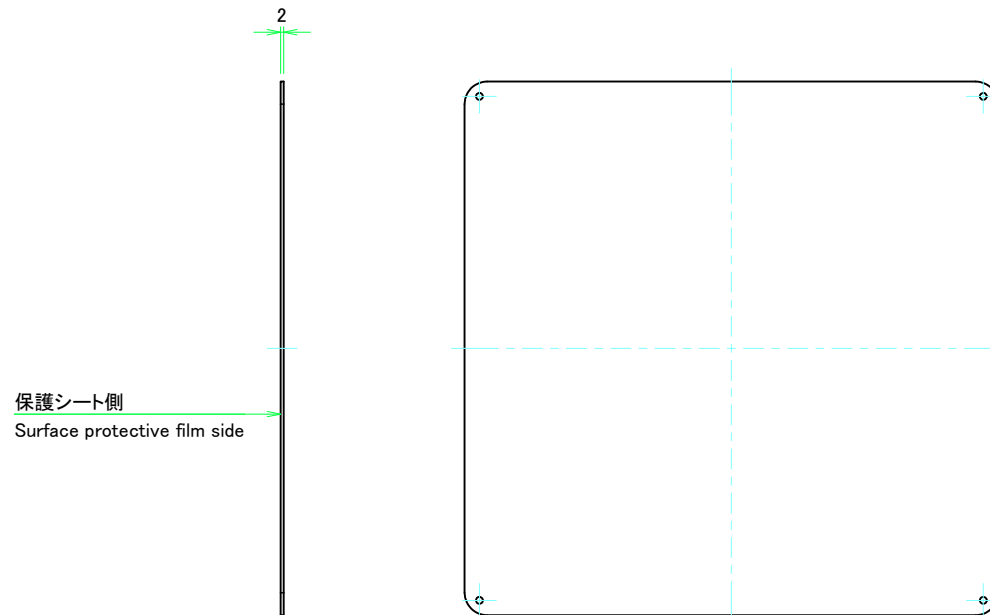

表面 / Front side



裏面 / Back side

 株式会社タカチ電機工業 TAKACHI ELECTRONICS ENCLOSURE CO., LTD.			品名/Title カバー Top cover	 尺度/Scale 1:3.5
承認/Approved 中根	検図/Checked 王	製図/Created 野村	型番/Product number	
W360 - D360			作成日/Date 2022/11/16	
本図面の著作権は株式会社タカチ電機工業に帰属します。 / Copyright (C) TAKACHI ELECTRONICS ENCLOSURE CO., LTD. All Rights Reserved.				

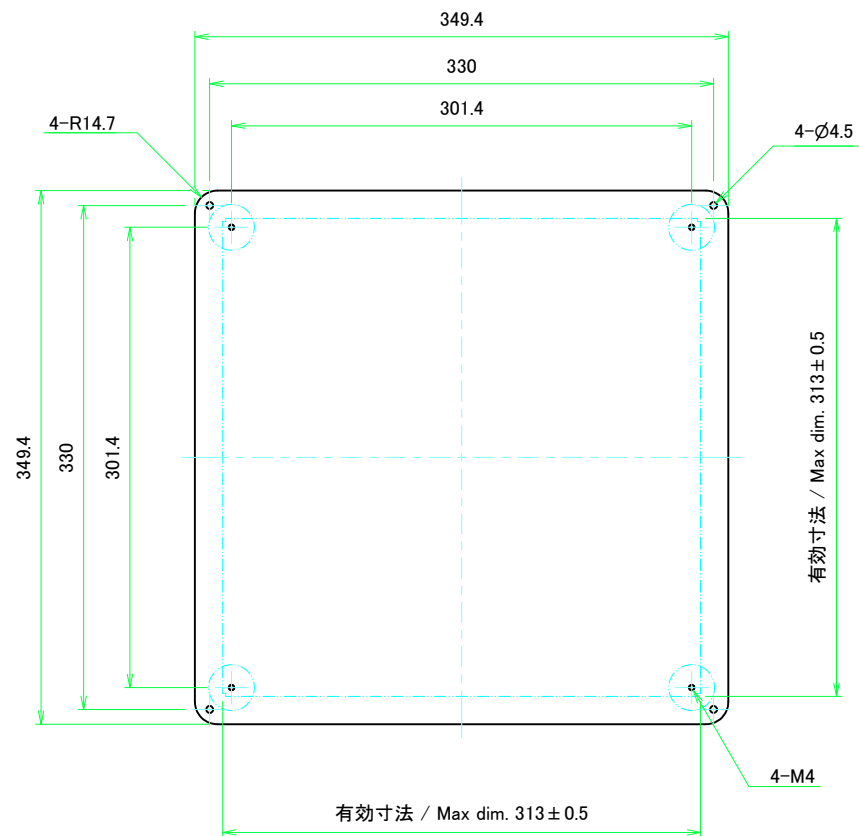

表面 / Front side

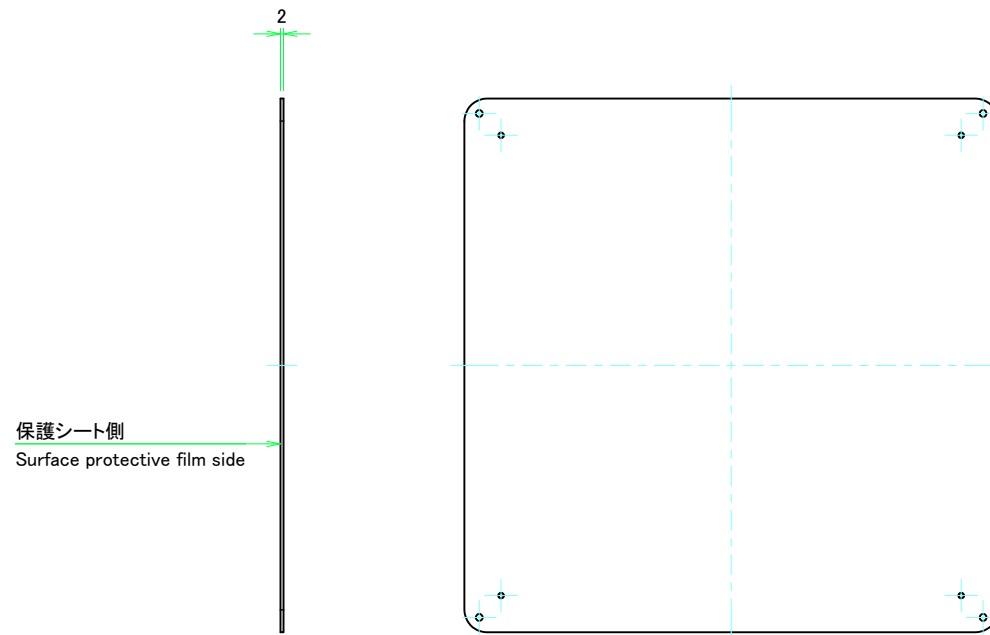

裏面 / Back side

株式会社タカチ電機工業 TAKACHI ELECTRONICS ENCLOSURE CO., LTD.			品名/Title 下カバー Bottom cover	尺度/Scale 1:3.5
承認/Approved 中根	検図/Checked 王	製図/Created 野村	型番/Product number	
W360 - D360			作成日/Date 2022/11/16	
本図面の著作権は株式会社タカチ電機工業に帰属します。 / Copyright (C) TAKACHI ELECTRONICS ENCLOSURE CO., LTD. All Rights Reserved.				