

B-B (1:6)

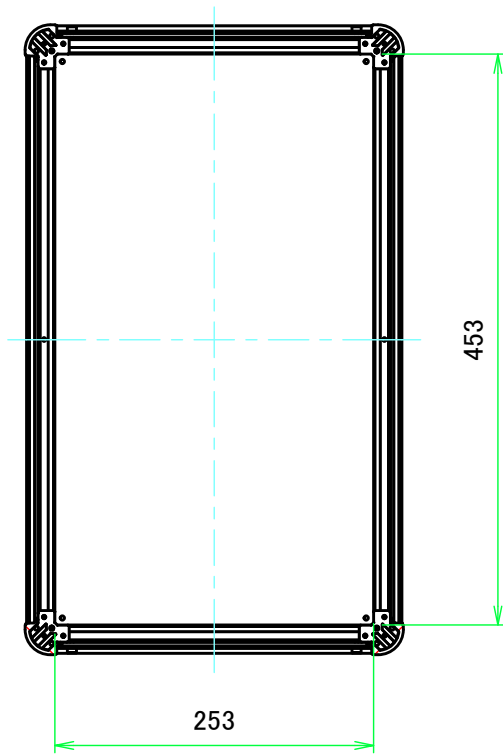

E view

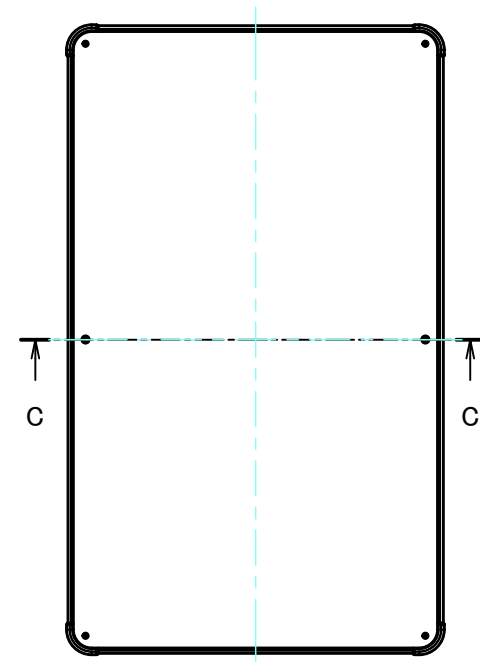

A-A (1:6)

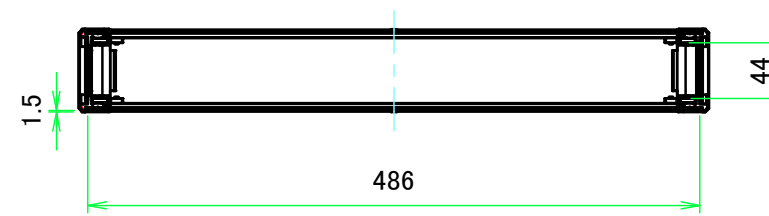

C-C (1:6)

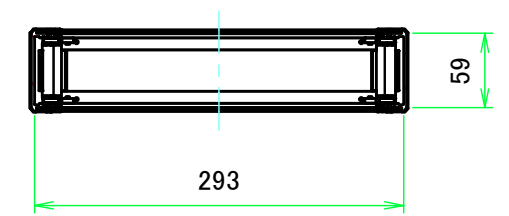

D view



A view

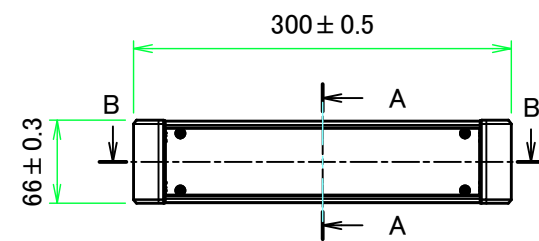

C view

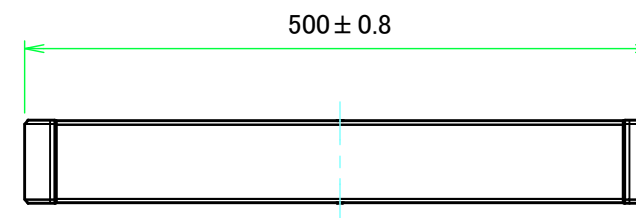

B view

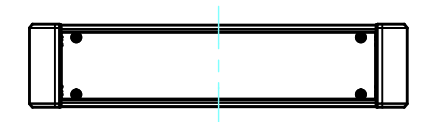

F view

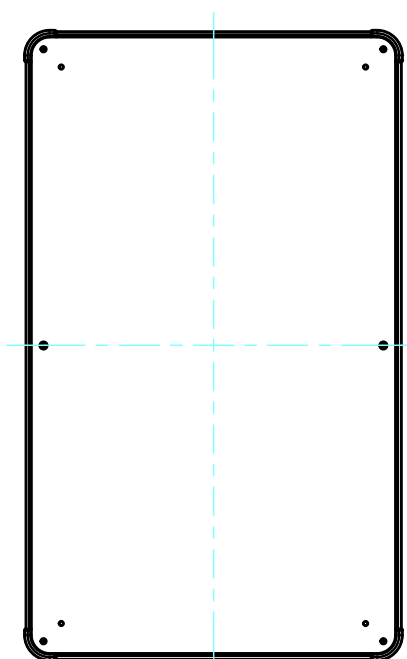

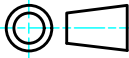
 株式会社タカチ電機工業 TAKACHI ELECTRONICS ENCLOSURE CO., LTD.			品名/Title パネル脱着EMCシールドケース EMC SHIELDED ENCLOSURE with DETACHABLE PANELS	 尺度/Scale 1:6
承認/Approved	検図/Checked	製図/Created	型番/Product number AUPE66-30-50□□-□□	
中根	王	常山	作成日/Date 2022/10/19	ページ/Page 2 / 7

C 側板 / C Frame

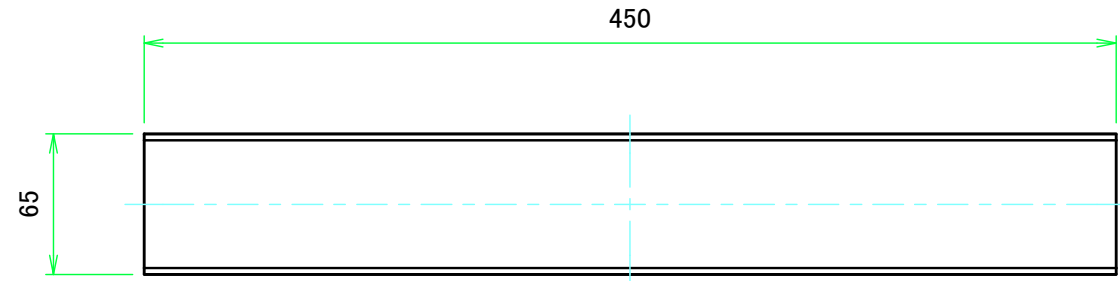

表面 / Front side

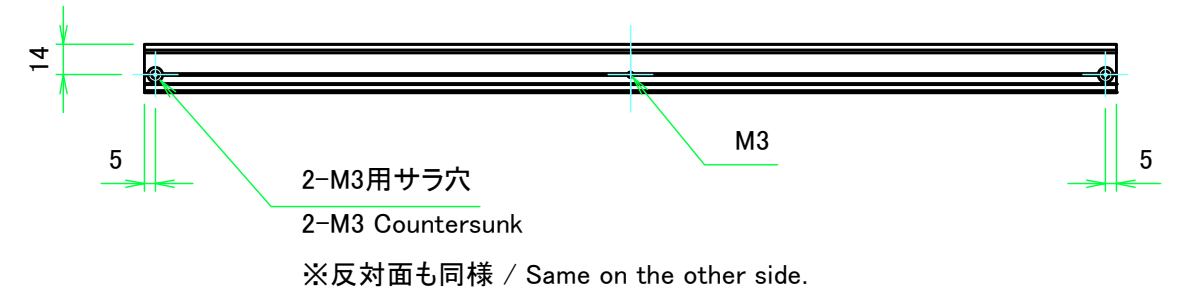
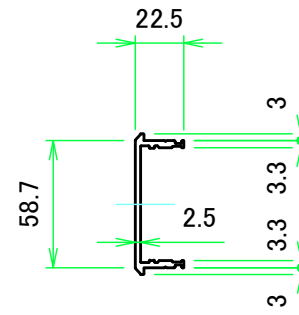

裏面 / Back side

D 側板 / D Frame

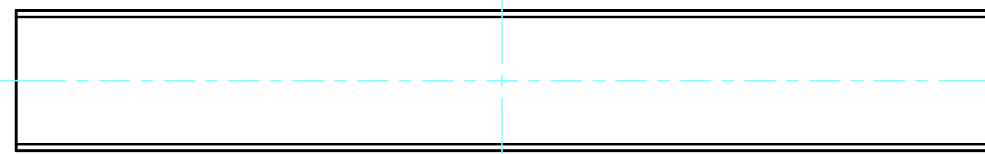

表面 / Front side



裏面 / Back side

株式会社タカチ電機工業 TAKACHI ELECTRONICS ENCLOSURE CO., LTD.			品名/Title 側板 Frame	尺度/Scale 1:3.5
承認/Approved 中根	検図/Checked 王	製図/Created 常山	型番/Product number H66 - D500	
			作成日/Date 2022/09/27	ページ/Page 3 / 7

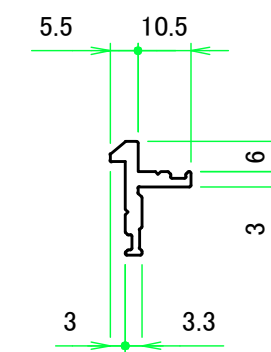
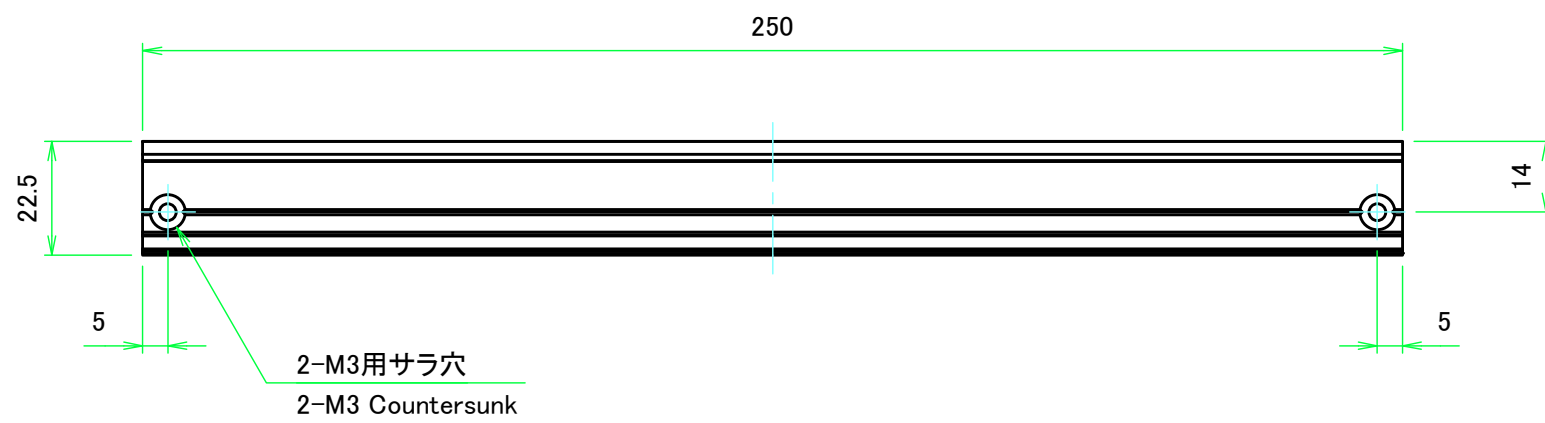
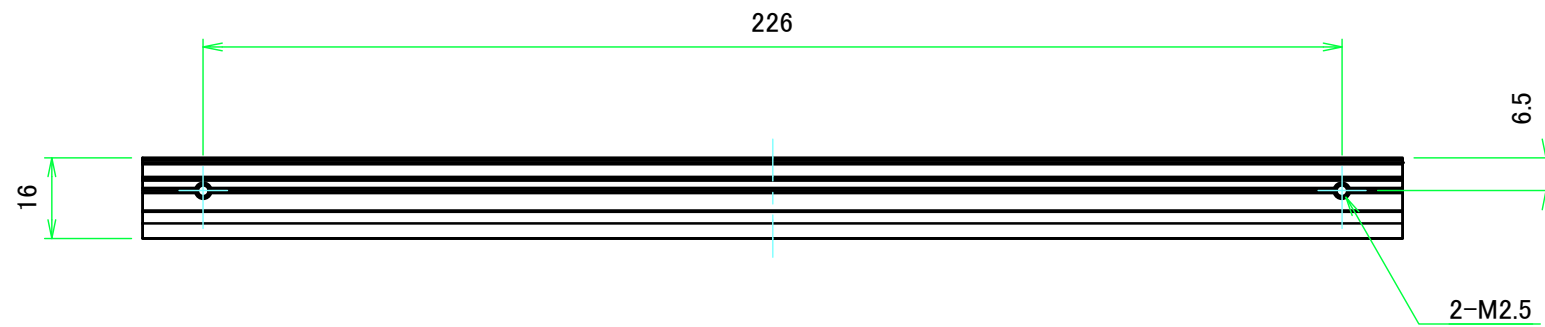

計4本 / Total 4 pieces

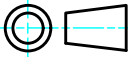
 株式会社タカチ電機工業 TAKACHI ELECTRONICS ENCLOSURE CO., LTD.			品名/Title フレーム Panel support frame	
承認/Approved	検図/Checked	製図/Created	型番/Product number W300	
中根	王	野村	作成日/Date 2022/08/08	ページ/Page 4 / 7

A パネル / A Panel

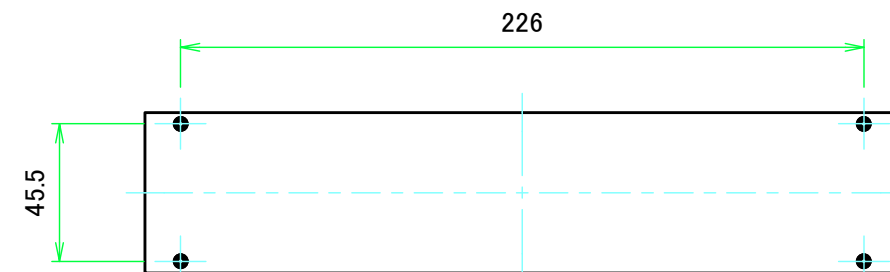
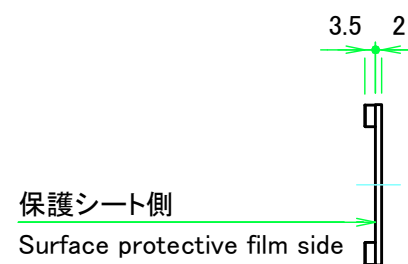
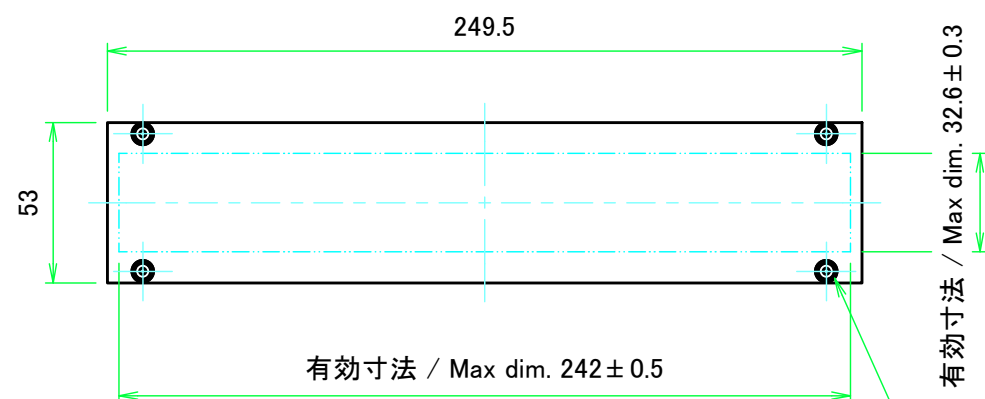

表面 / Front side

裏面 / Back side

4-M2.5用メタルスリーブ
4-Metal sleeve for M2.5

B パネル / B Panel

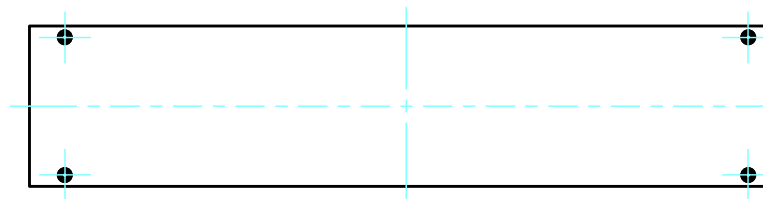
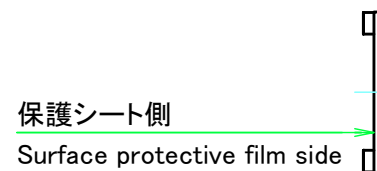
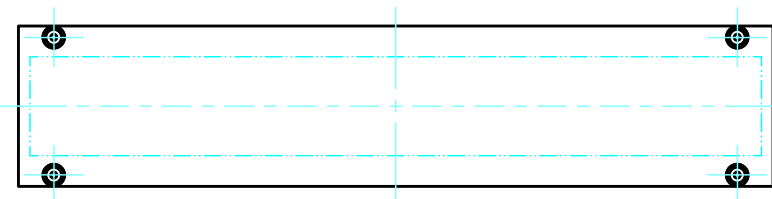

表面 / Front side

裏面 / Back side

株式会社タカチ電機工業 TAKACHI ELECTRONICS ENCLOSURE CO., LTD.			品名/Title パネル Panel	
承認/Approved	検図/Checked	製図/Created	型番/Product number H66 - W300	尺度/Scale 1:2.5
中根	王	常山	作成日/Date 2022/10/14	ページ/Page 5 / 7

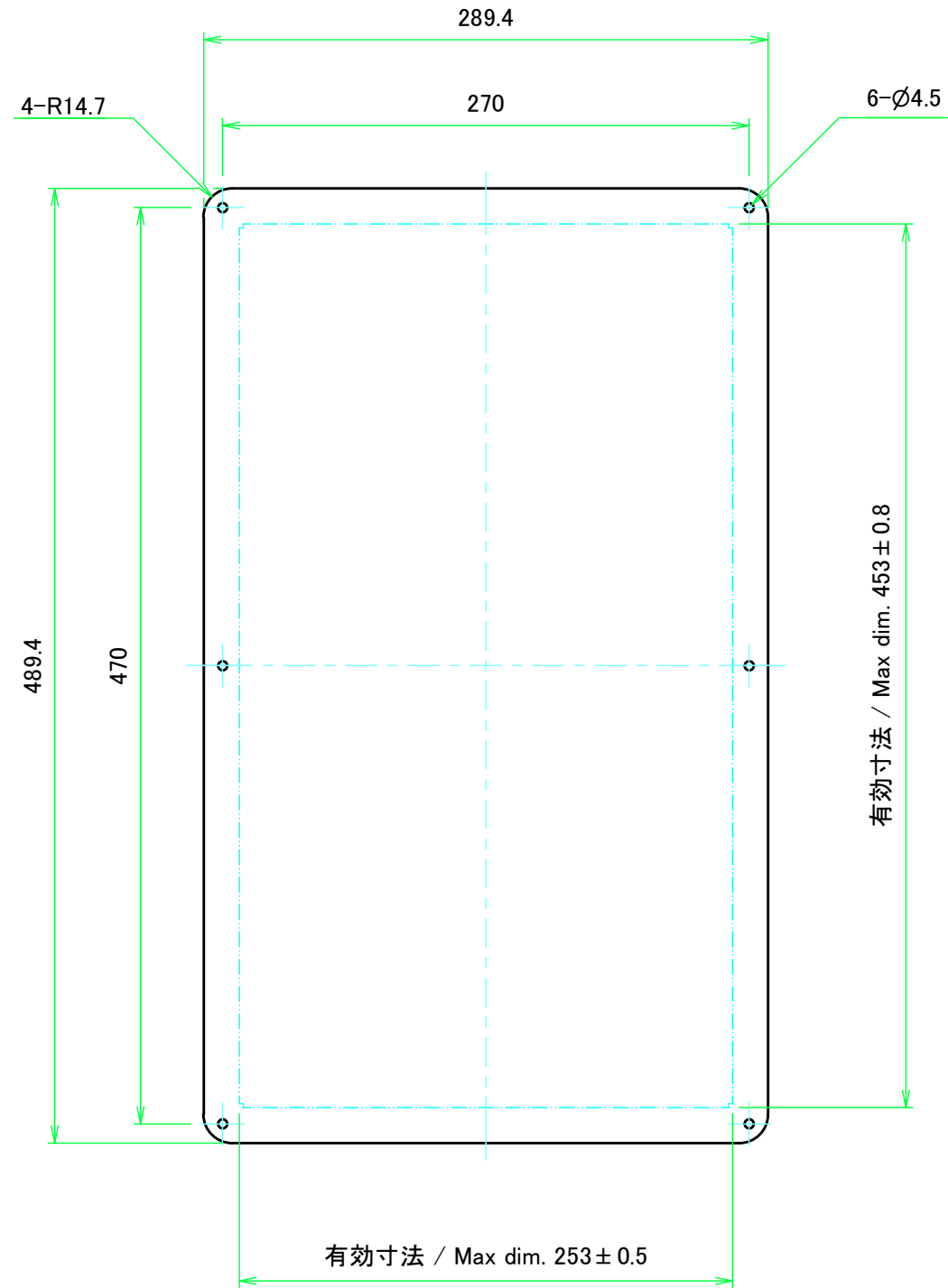

表面 / Front side

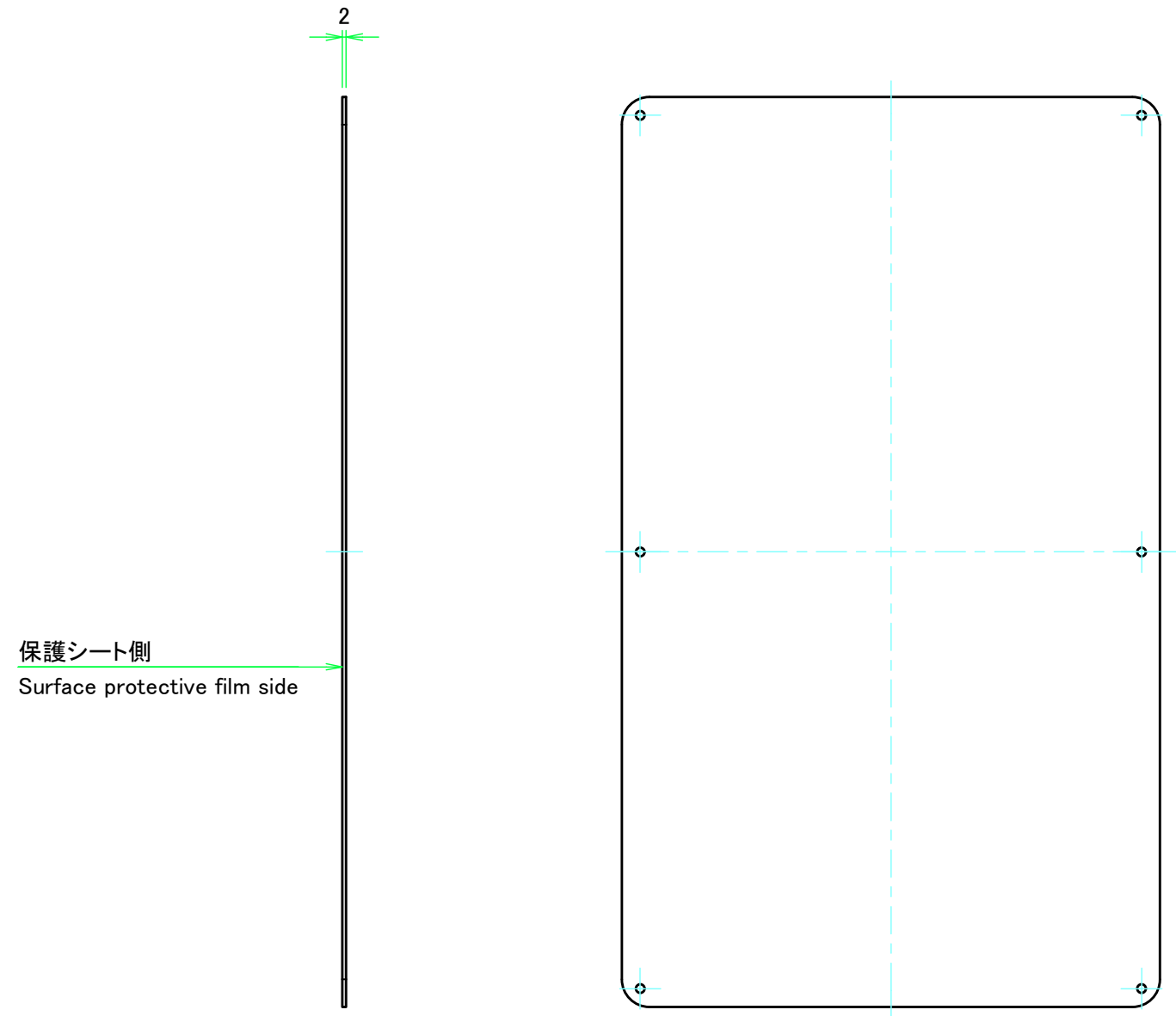

裏面 / Back side

 株式会社タカチ電機工業 <small>TAKACHI ELECTRONICS ENCLOSURE CO., LTD.</small>			品名/Title カバー Top cover	
承認/Approved	検図/Checked	製図/Created	型番/Product number W300 - D500	
中根	王	野村	作成日/Date 2022/07/20	ページ/Page 6 / 7

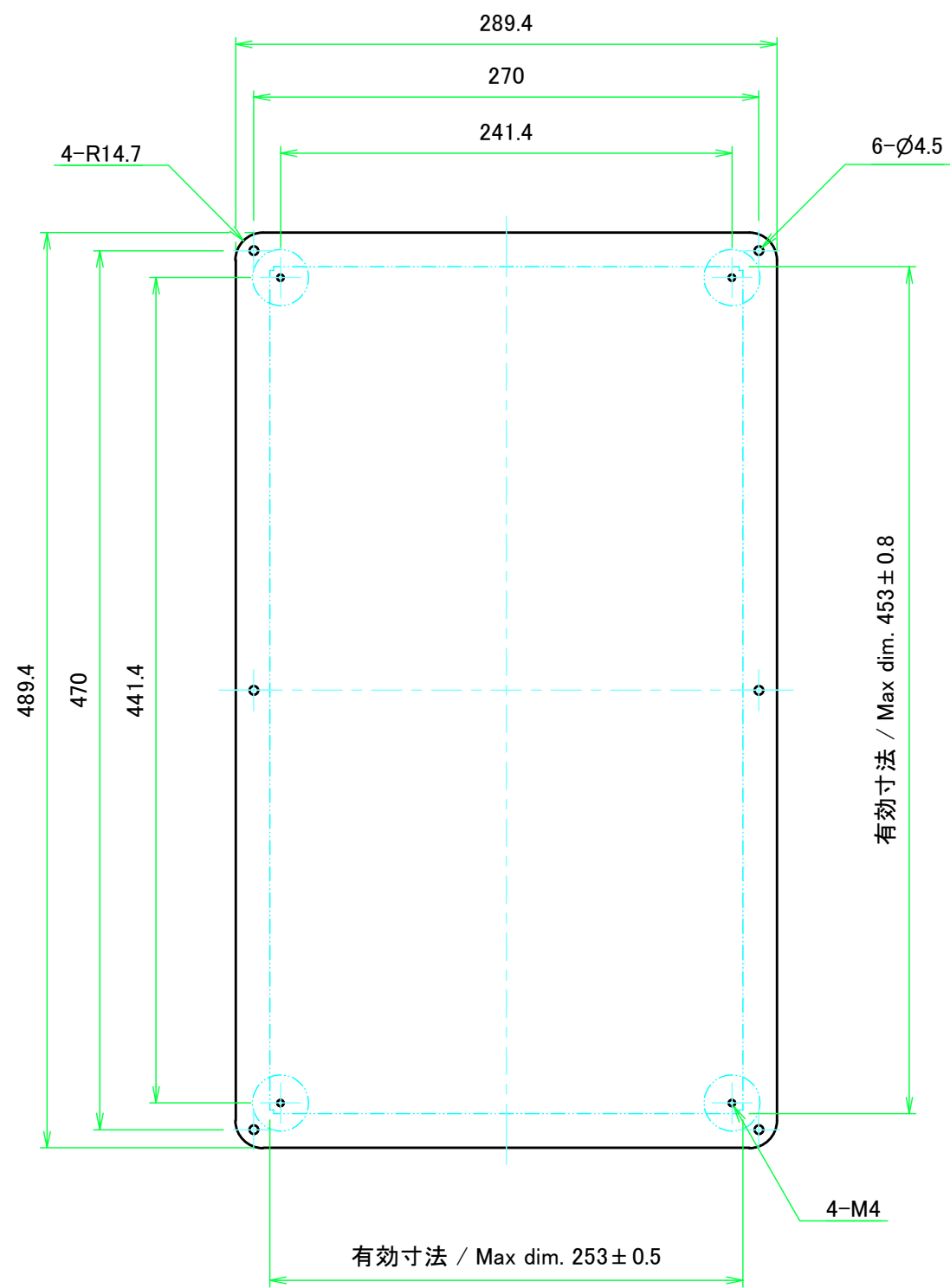

表面 / Front side

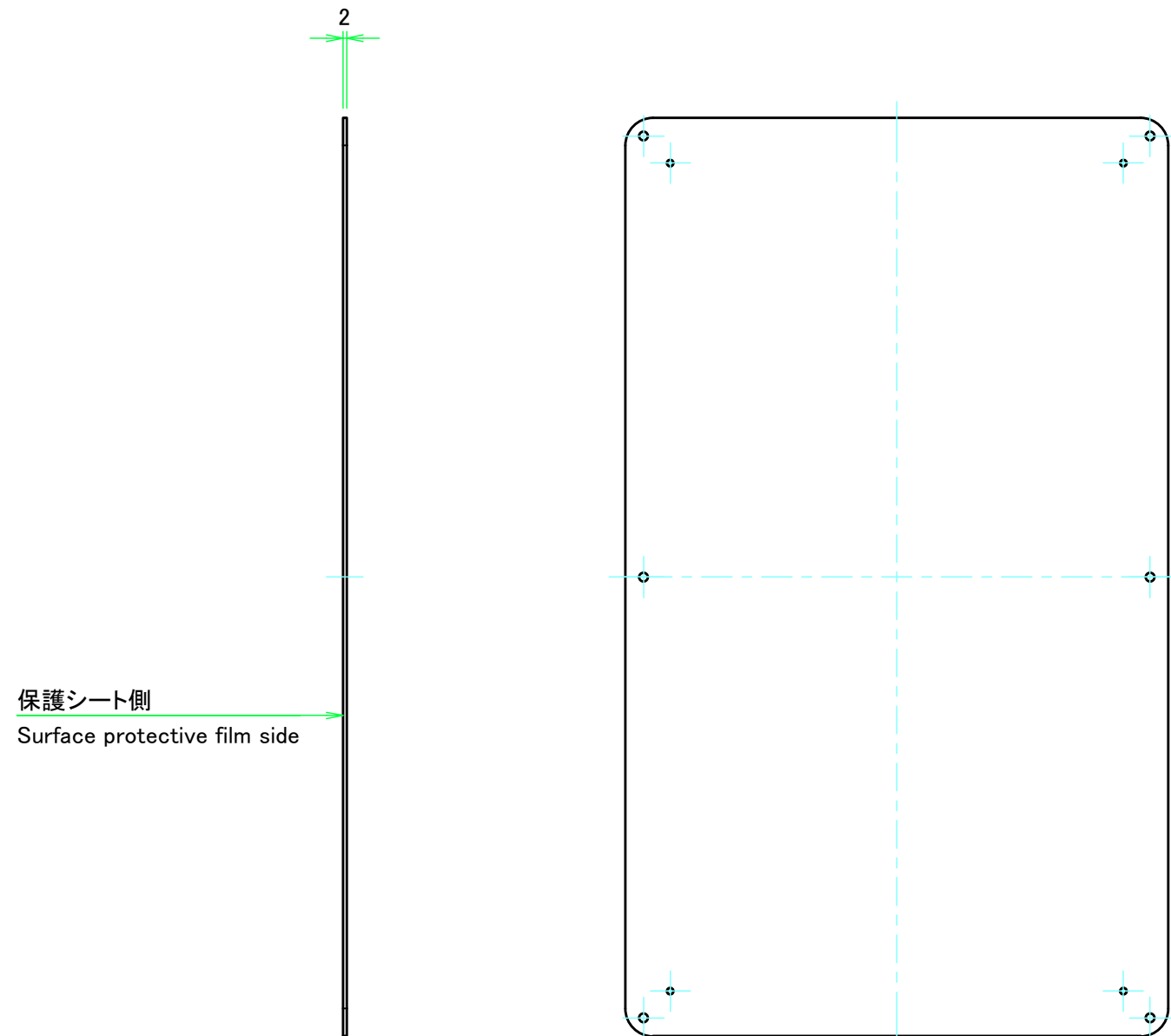

裏面 / Back side

 株式会社タカチ電機工業 <small>TAKACHI ELECTRONICS ENCLOSURE CO., LTD.</small>			品名/Title 下カバー Bottom cover	
承認/Approved	検図/Checked	製図/Created	型番/Product number W300 - D500	
中根	王	野村	作成日/Date 2022/07/20	ページ/Page 7 / 7