

B-B (1:6)

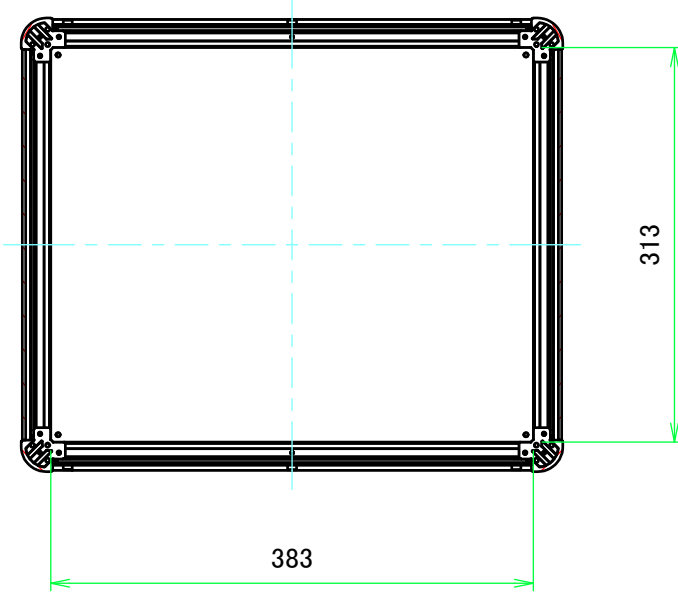

E view

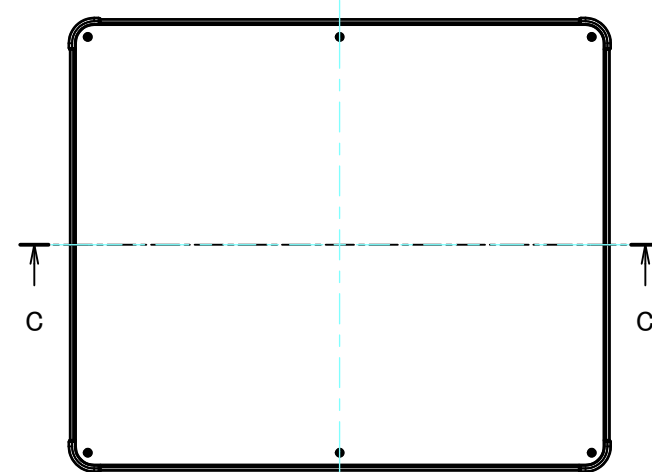

A-A (1:6)

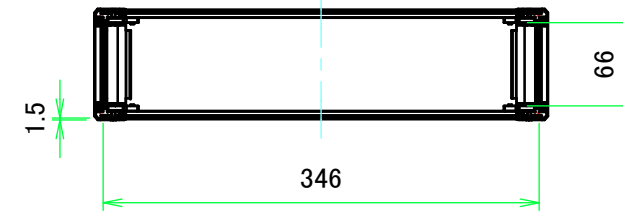

C-C (1:6)

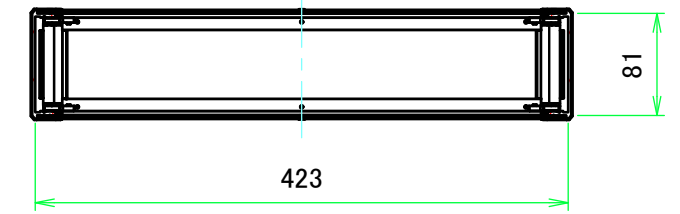

D view

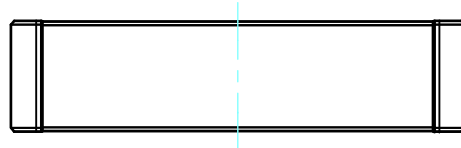

A view

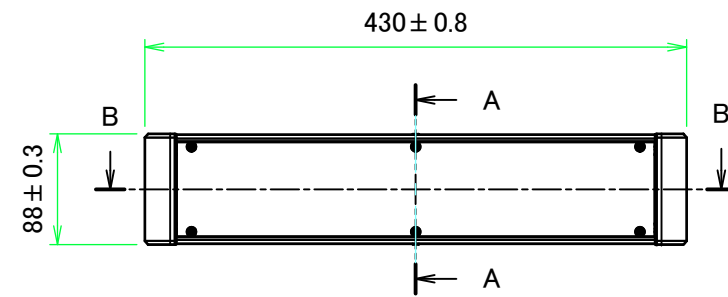

C view

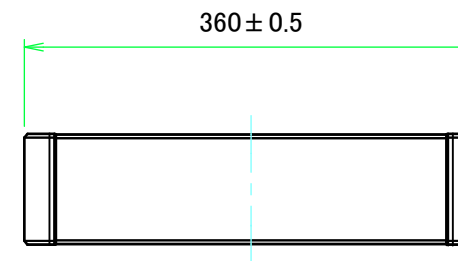

B view

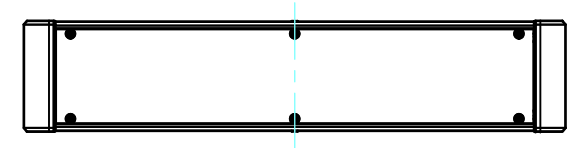

F view

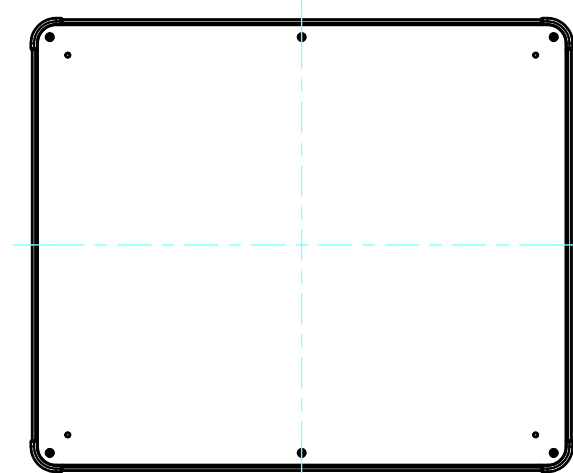

株式会社タカチ電機工業 TAKACHI ELECTRONICS ENCLOSURE CO., LTD.		品名/Title パネル脱着EMCシールドケース EMC SHIELDED ENCLOSURE with DETACHABLE PANELS	尺度/Scale 1:6
承認/Approved	検図/Checked	製図/Created	
中根	王	野村	作成日/Date 2022/08/24
			ページ/Page 2 / 7

C 側板 / C Frame

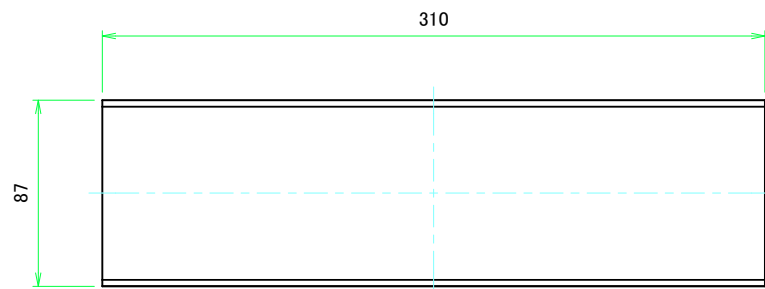

表面 / Front side

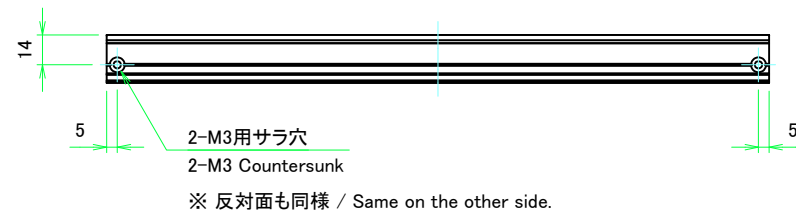
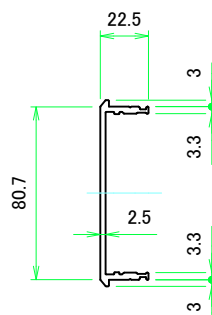

裏面 / Back side

D 側板 / D Frame

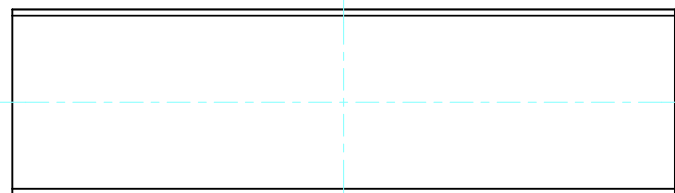

表面 / Front side

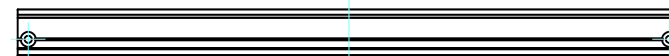
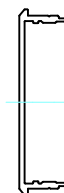

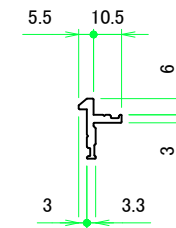
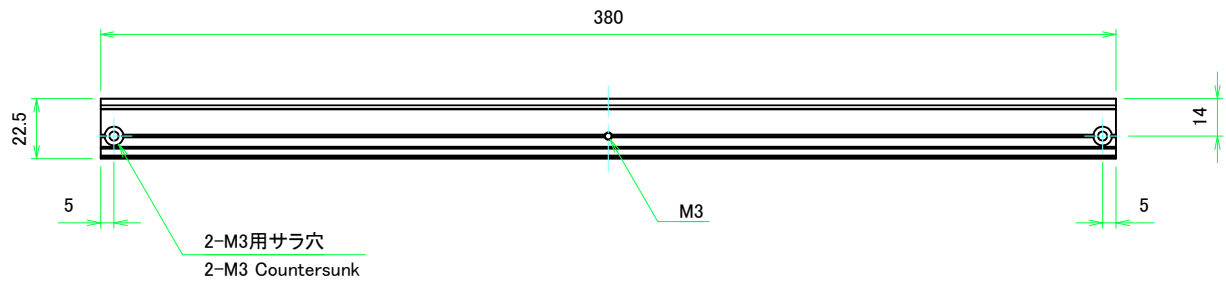
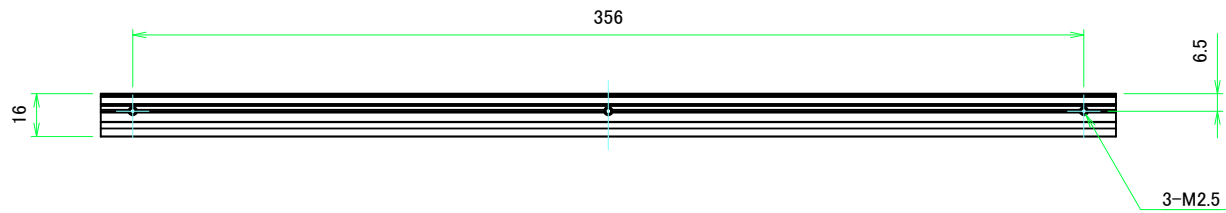

裏面 / Back side

株式会社タカチ電機工業 TAKACHI ELECTRONICS ENCLOSURE CO., LTD.			品名/Title 側板 Frame	尺度/Scale 1:2.5
承認/Approved	検図/Checked	製図/Created	型番/Product number H88 - D360	
中根	王	野村	作成日/Date 2022/07/20	ページ/Page 3 / 7



計4本 / Total 4 pieces

 株式会社タカチ電機工業 <small>TAKACHI ELECTRONICS ENCLOSURE CO., LTD.</small>			品名/Title フレーム Panel support frame	 尺度/Scale 1:2
承認/Approved	検図/Checked	製図/Created	型番/Product number W430	
中根	王	野村	作成日/Date 2022/08/08	ページ/Page 4 / 7

A パネル / A Panel

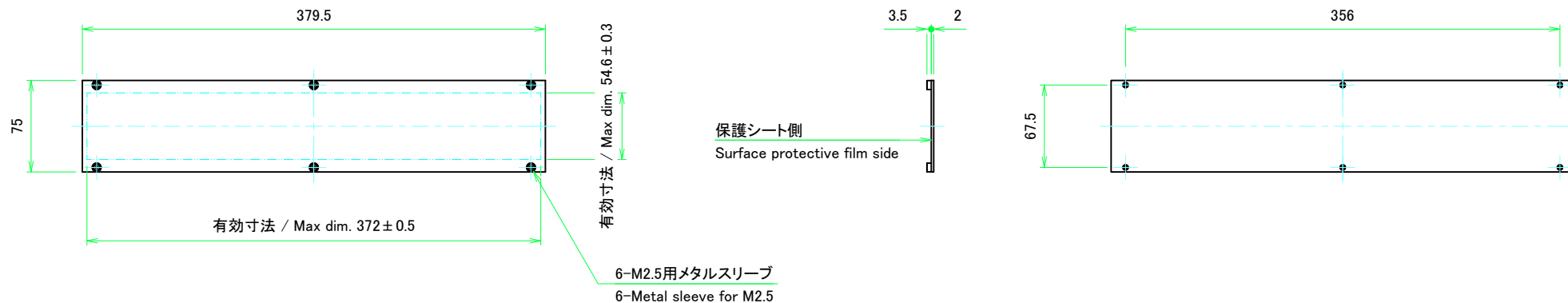

表面 / Front side

裏面 / Back side

B パネル / B Panel

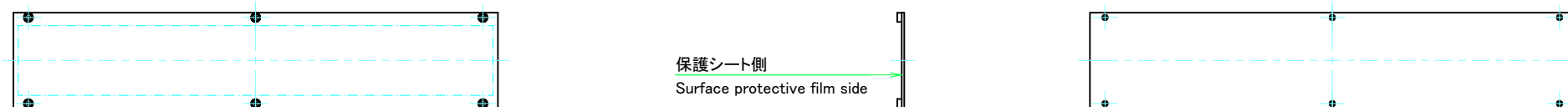

表面 / Front side

裏面 / Back side

株式会社タカチ電機工業 <small>TAKACHI ELECTRONICS ENCLOSURE CO., LTD.</small>			品名 / Title パネル Panel	
承認 / Approved	検図 / Checked	製図 / Created	型番 / Product number H88 - W430	尺度 / Scale 1:3.5
中根	王	野村	作成日 / Date 2022/08/08	ページ / Page 5 / 7

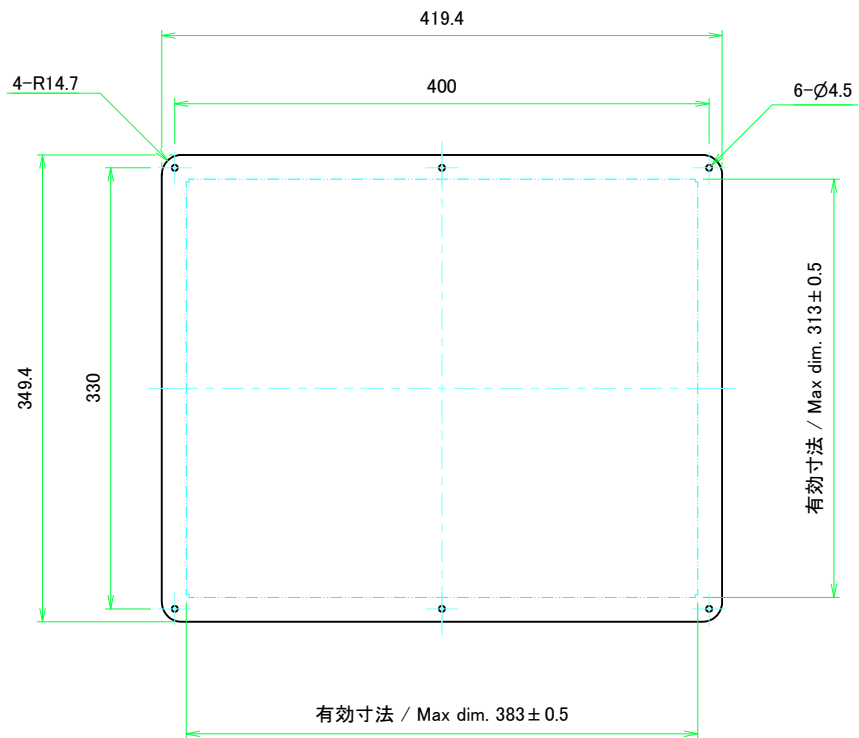

表面 / Front side

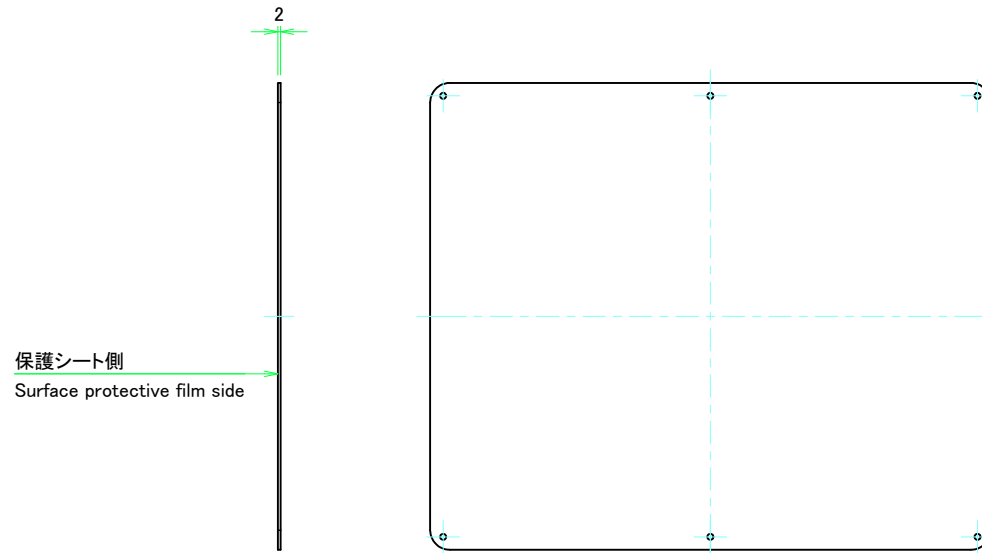

裏面 / Back side

株式会社タカチ電機工業 <small>TAKACHI ELECTRONICS ENCLOSURE CO., LTD.</small>			品名/Title カバー Top cover	尺度/Scale 1:4
承認/Approved	検図/Checked	製図/Created	型番/Product number W430 - D360	
中根	王	野村	作成日/Date 2022/07/20	

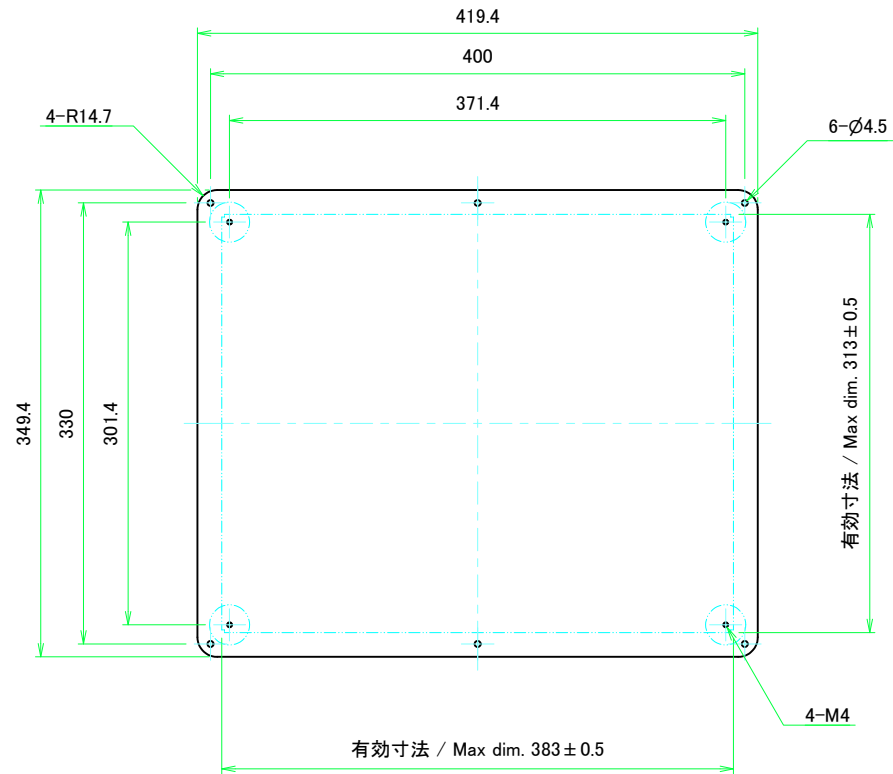

表面 / Front side

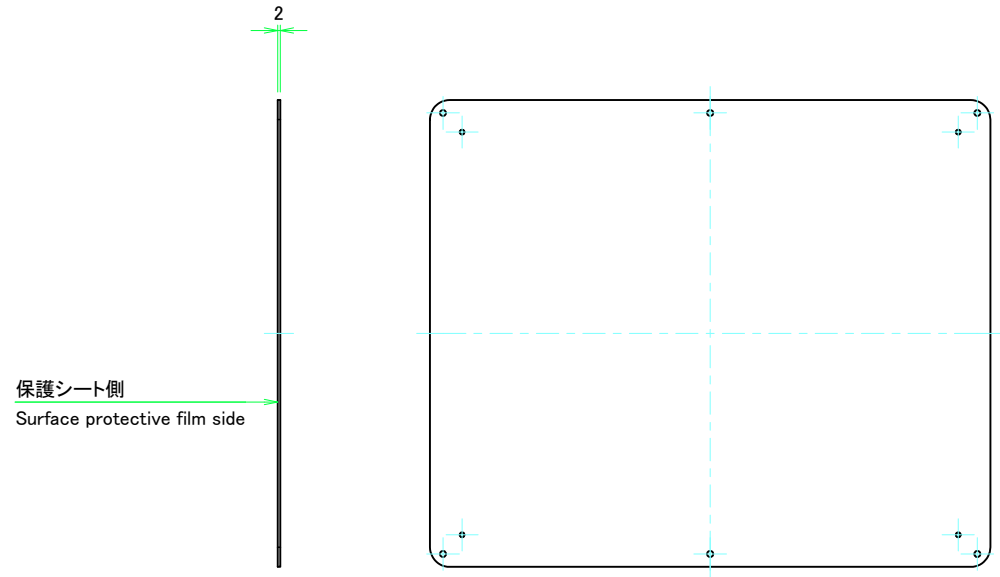

裏面 / Back side

株式会社タカチ電機工業 <small>TAKACHI ELECTRONICS ENCLOSURE CO., LTD.</small>			品名/Title 下カバー Bottom cover	尺度/Scale 1:4
承認/Approved 中根	検図/Checked 王	製図/Created 野村	型番/Product number W430 - D360	
			作成日/Date 2022/07/20	