

■テクニカルデータ/Technical Data■	
保護等級/Protection class	IP68(水深1m 24h)/IP68(24hours/1m depth)
温度範囲/Operating temperature	-40°C~+105°C
締め付けトルク/Recommended torque	1.0N・m(10kgf・cm)
※熱抵抗値/Thermal resistant rate	1.63°C/W

- ※熱抵抗値算出の条件/Thermal resistance test condition
- ・自然空冷/Ambient air cooling
  - ・フィンが地面に垂直で温度上昇60°Cの時/Heat-sink fins are set perpendicular to the ground with temperature at 60°C
  - ・押し出しがアルマイト品/Anodized extruded aluminium
  - ・全面素子/Heat source is applied on the opposite side (inner side) of the fins

構成内容 / Components				
No.	名称 / Part name	数量 / Pcs	材質 / Material	色・表面処理 / Color・Finish
1	フランジ付側板/Flanged end panel	2	ADC12/Diecast aluminiumADC12	シルバー・ブラック・塗装(内面未処理)/Silver,black・Painted (unfinished inside)
2	ボディフレーム/Body frame	1	アルミ押出材/Extruded aluminium A6063S-T5	シルバー・ブラック・アルマイト&クリア塗装/Silver,black・Anodized with clear coating
3	シールドガスケット/Conductive gasket	2	導電性シリコン/Conductive silicone	ブラック/Black
4	取付ビス/Screw	8	ステンレス(パイント)M4×12/Stainless steel	無処理/Unfinished

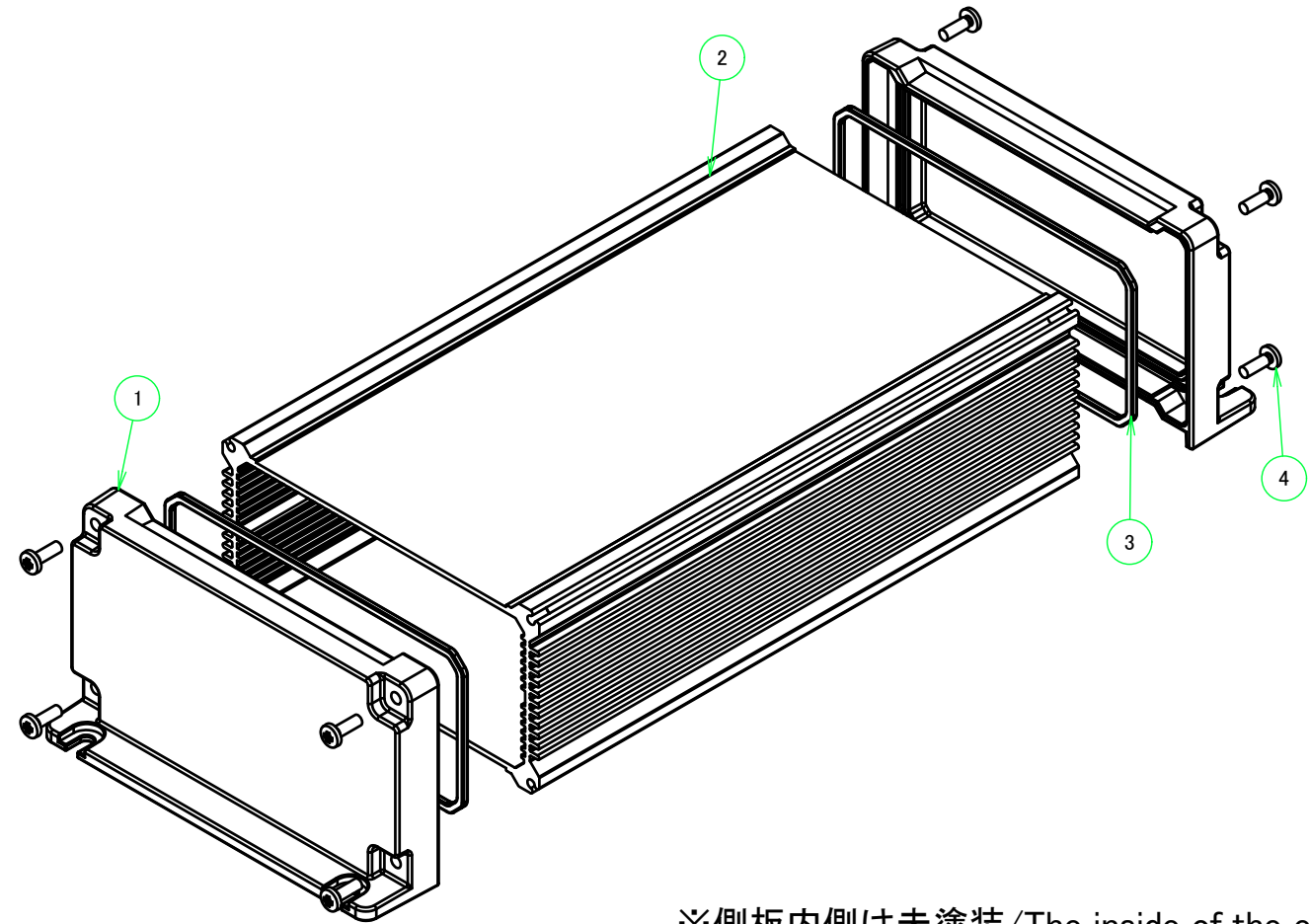
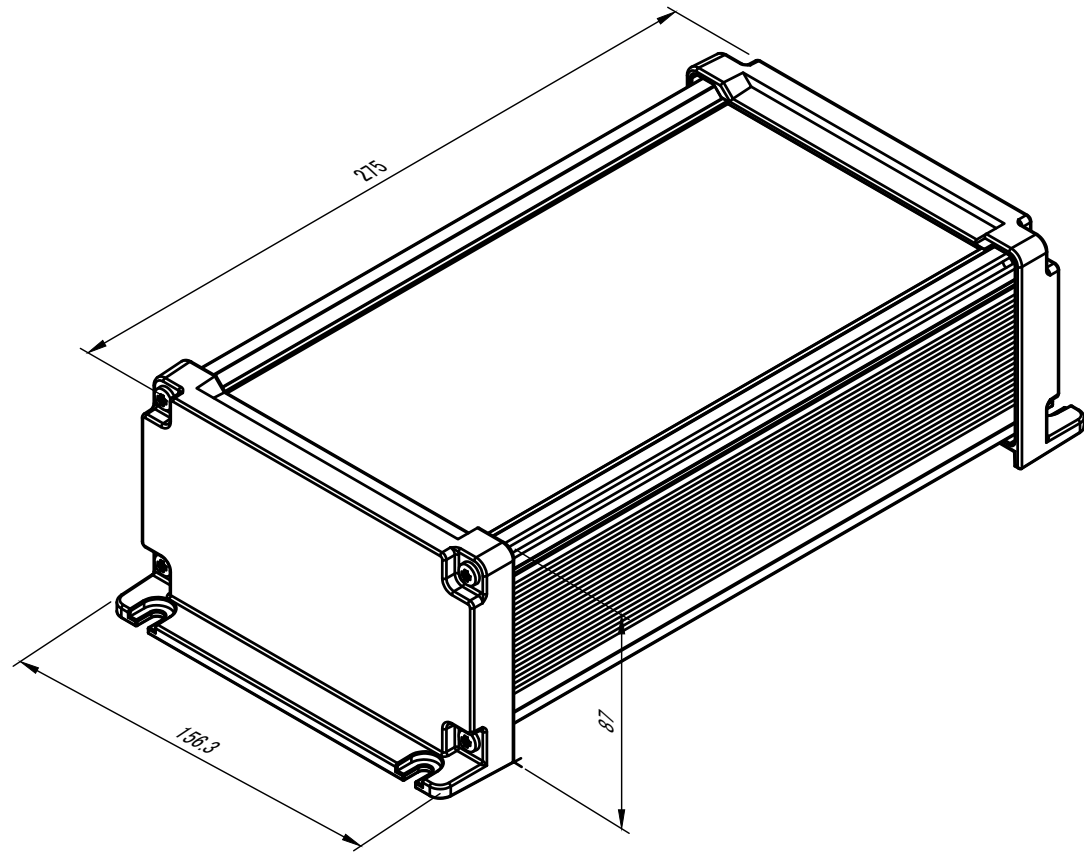

※側板内側は未塗装/The inside of the end panels are unpainted for shielding

本図面および付帯する部品図の著作権は株式会社タカチ電機工業に帰属します。 / Copyright (C) TAKACHI ELECTRONICS ENCLOSURE CO., LTD. All Rights Reserved.

色仕様(型番末尾□□)/Color type		
記号/Code	パネル/Panel	ボディフレーム/Body frame
SS	シルバー/Silver	シルバー/Silver
BS	ブラック/Black	シルバー/Silver
BB	ブラック/Black	ブラック/Black

<b>TAKACHI</b> 株式会社タカチ電機工業 TAKACHI ELECTRONICS ENCLOSURE CO., LTD.		品名/Title フランジ足付防水・防塵アルミケース IP68 FLANGED ALUMINIUM ENCLOSURE	
承認/Approved 中根	検図/Checked 王	製図/Created 岡本	
型番/Product number AW16-9-28E□□			尺度/Scale 1 : 2.5
作成日/Date 2023/04/17			1 / 4

フランジ付側板1  
Flanged end panel 1

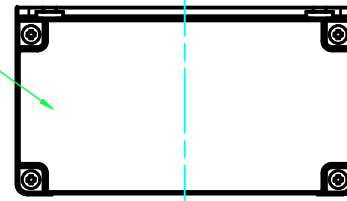

B-B (1:3.5)

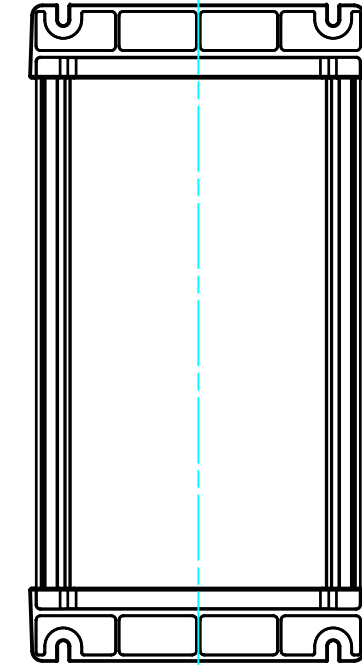
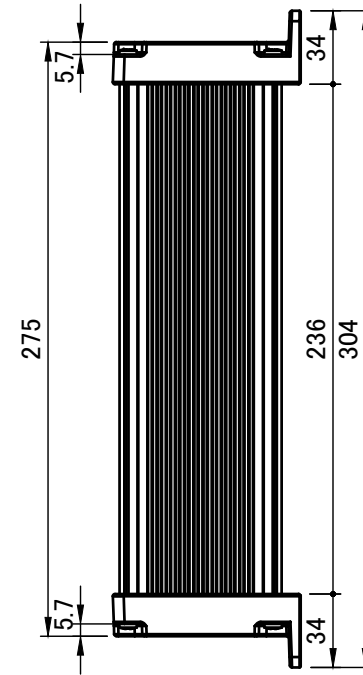
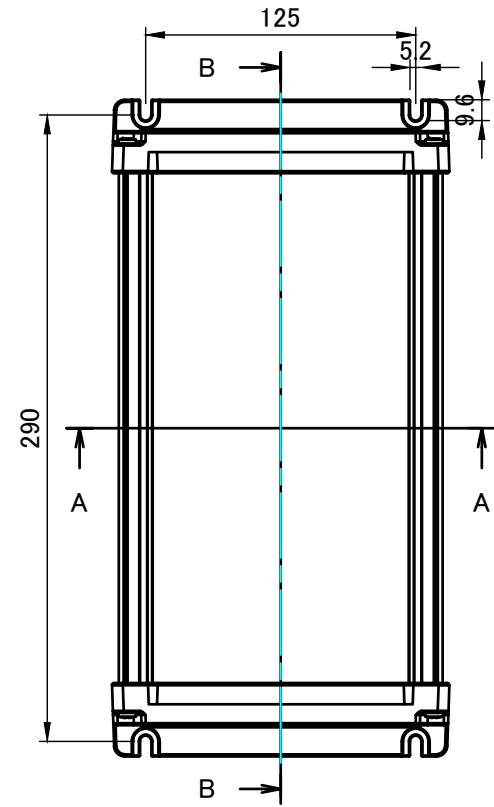
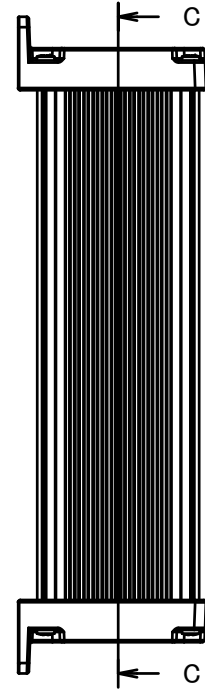
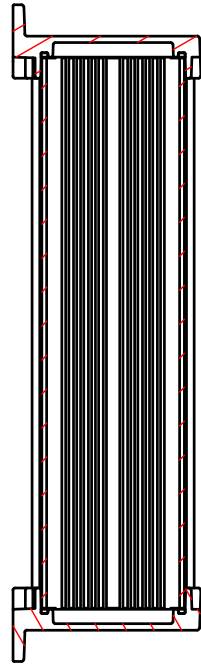

フランジ付側板2  
Flanged end panel 2

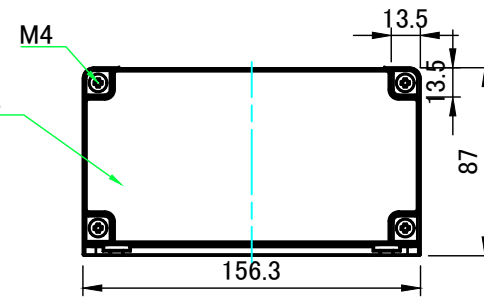

A-A (1:3.5)

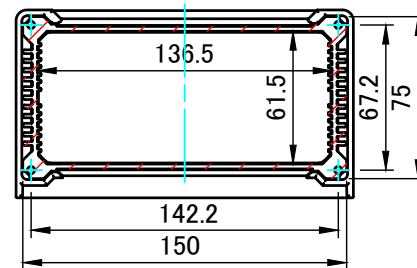

C-C (1:3.5)

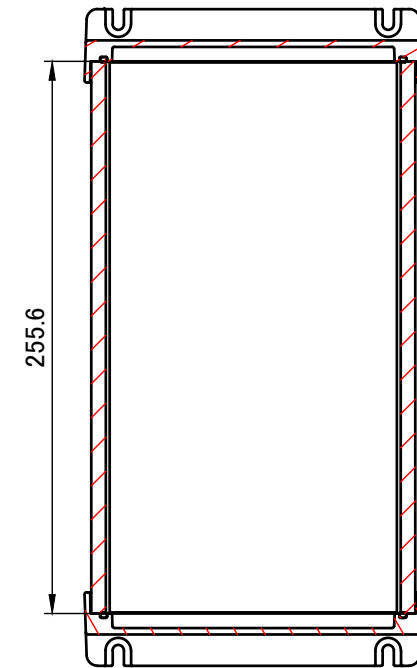

<b>株式会社タカチ電機工業</b> TAKACHI ELECTRONICS ENCLOSURE CO., LTD.			品名/Title フランジ足付防水・防塵アルミケース IP68 FLANGED ALUMINIUM ENCLOSURE	尺度/Scale 1 : 3.5
承認/Approved	検図/Checked	製図/Created	型番/Product number AW16-9-28E□□	
中根	王	岡本	作成日/Date 2023/04/17	2 / 4

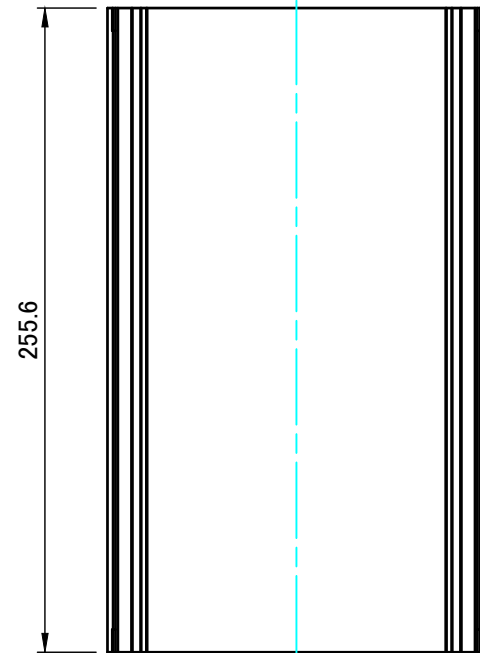
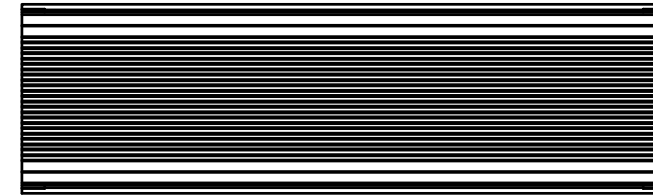
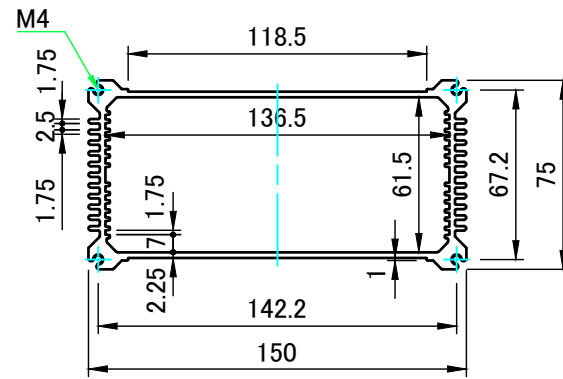
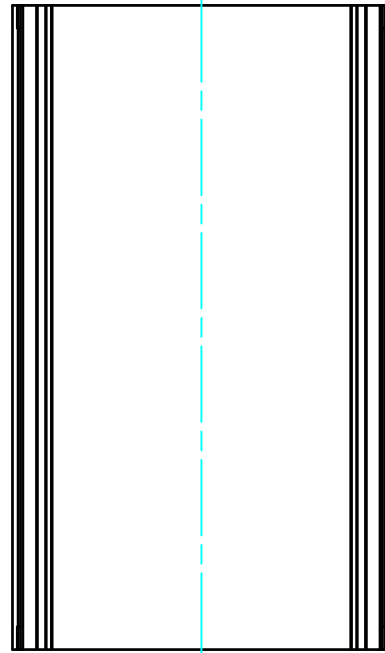
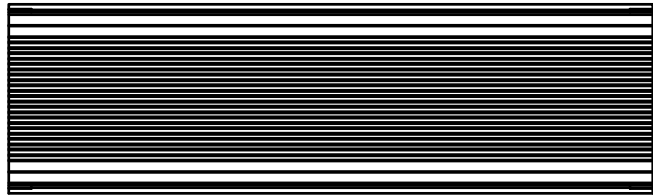

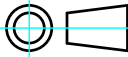
 株式会社タカチ電機工業 TAKACHI ELECTRONICS ENCLOSURE CO., LTD.			品名/Title ボディフレーム Body frame	
承認/Approved 中根	検図/Checked 王	製図/Created 岡本	型番/Product number W150-H75-D255.6	
			作成日/Date 2017/07/18	3 / 4

フランジ付側板1  
Flanged end panel 1

A-A (1:2.5)

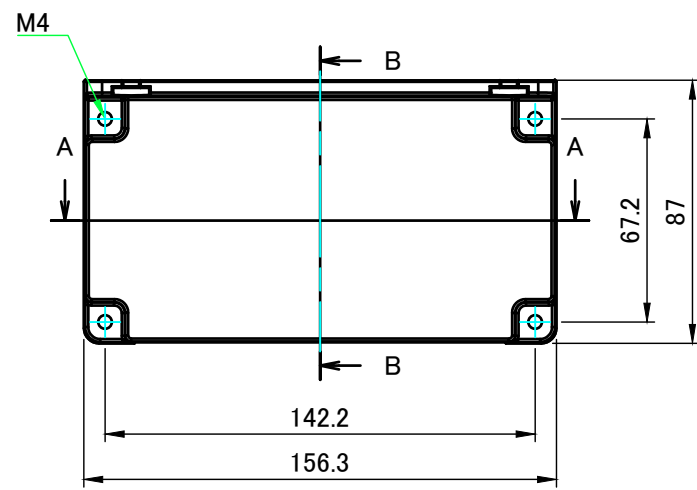
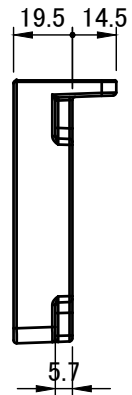
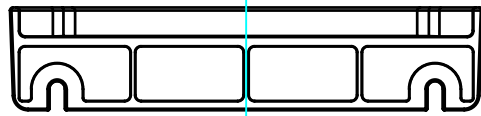
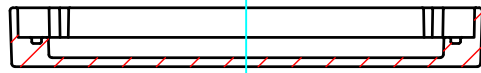

B-B (1:2.5)

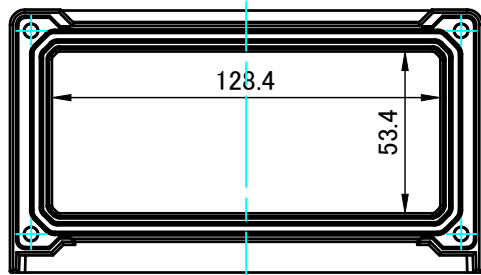
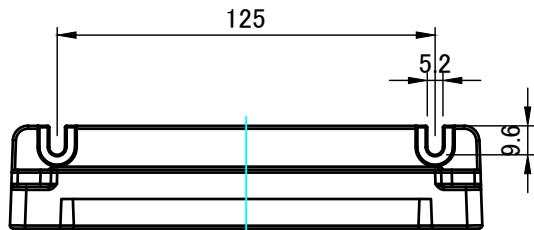
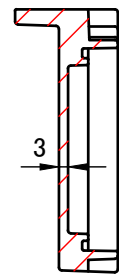

フランジ付側板2  
Flanged end panel 2

C-C (1:2.5)

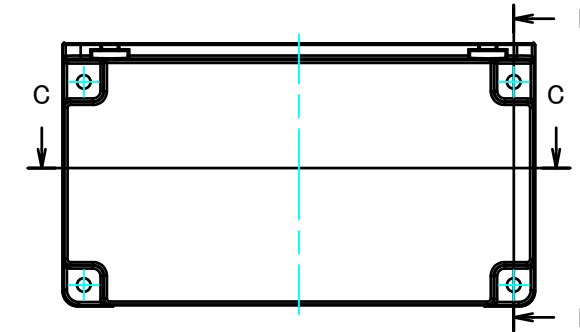
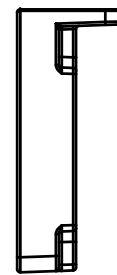
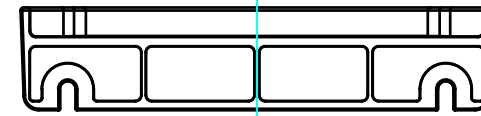
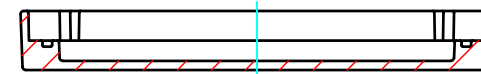

D-D (1:2.5)

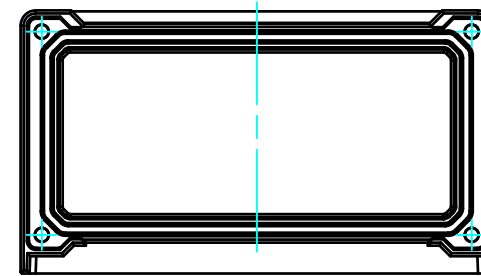
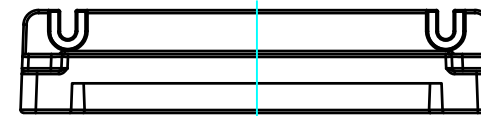
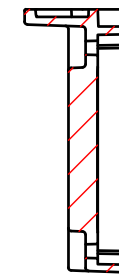

<b>株式会社タカチ電機工業</b> TAKACHI ELECTRONICS ENCLOSURE CO., LTD.			品名/Title フランジ付側板 Flanged end panel	尺度/Scale 1:2.5
承認/Approved	検図/Checked	製図/Created	型番/Product number W150-H75	
中根	王	岡本	作成日/Date 2017/07/19	4 / 4