

| ■テクニカルデータ/Technical Data■ | |
|------------------------------|---------------------------------------|
| 保護等級/Protection class | IP68(水深1m 24h)/IP68(24hours/1m depth) |
| 温度範囲/Operating temperature | -40°C~+105°C |
| 締め付けトルク/Recommended torque | 1.0N・m(10kgf・cm) |
| ※熱抵抗値/Thermal resistant rate | 1.54°C/W |

- ※熱抵抗値算出の条件/Thermal resistance test condition
- ・自然空冷/Ambient air cooling
 - ・フィンが地面に垂直で温度上昇60°Cの時/Heat-sink fins are set perpendicular to the ground with temperature at 60°C
 - ・押し出しがアルマイト品/Anodized extruded aluminium
 - ・全面素子/Heat source is applied on the opposite side (inner side) of the fins

| 構成内容 / Components | | | | |
|-------------------|-----------------------------|----------|-------------------------------------|--|
| No. | 名称 / Part name | 数量 / Pcs | 材質 / Material | 色・表面処理 / Color・Finish |
| 1 | フランジ付側板/Flanged end panel | 2 | ADC12/Diecast aluminiumADC12 | シルバー・ブラック・塗装(内面未処理)/Silver,black・Painted (unfinished inside) |
| 2 | ボディフレーム/Body frame | 1 | アルミ押出材/Extruded aluminium A6063S-T5 | シルバー・ブラック・アルマイト&クリア塗装/Silver,black・Anodized with clear coating |
| 3 | シールドガスケット/Conductive gasket | 2 | 導電性シリコン/Conductive silicone | ブラック/Black |
| 4 | 取付ビス/Screw | 8 | ステンレス(パイント)M5×12/Stainless steel | 無処理/Unfinished |

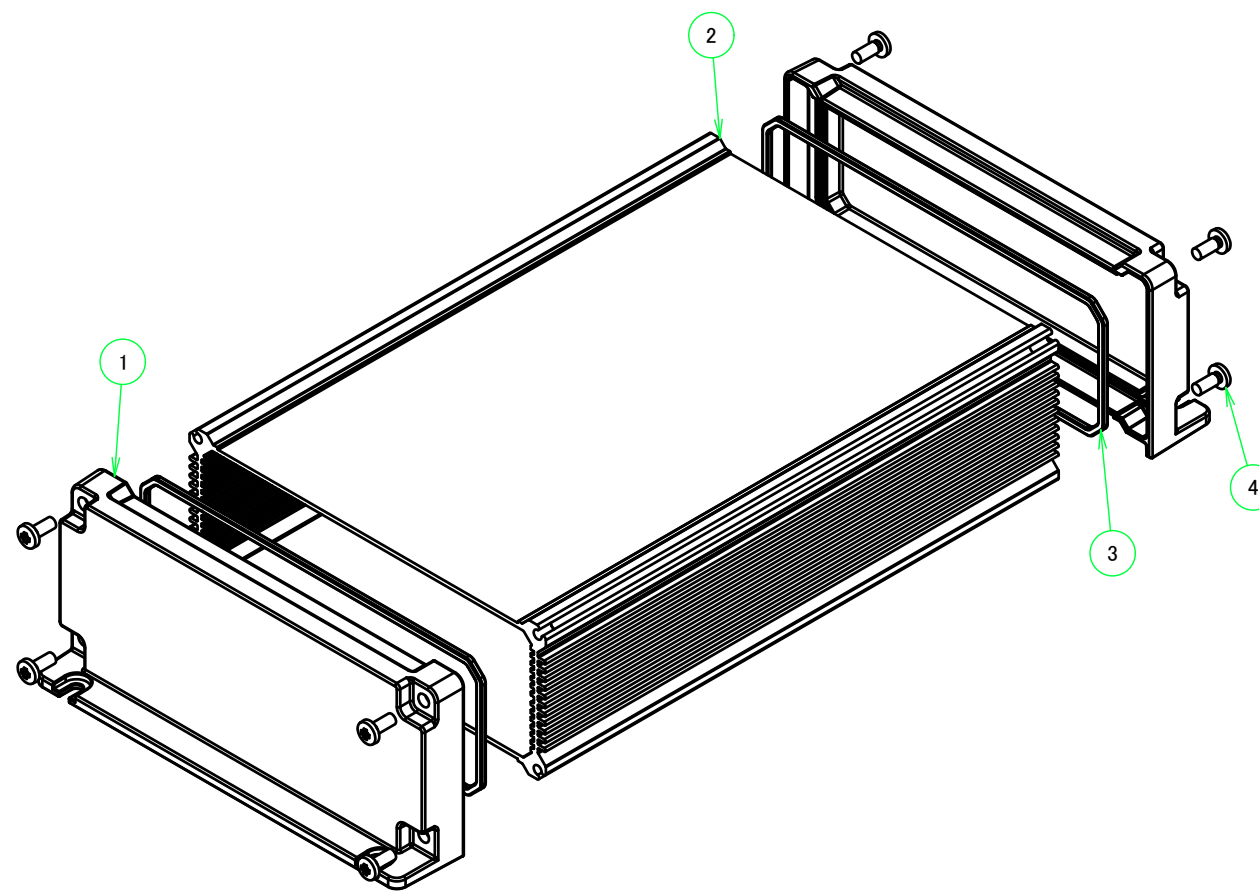
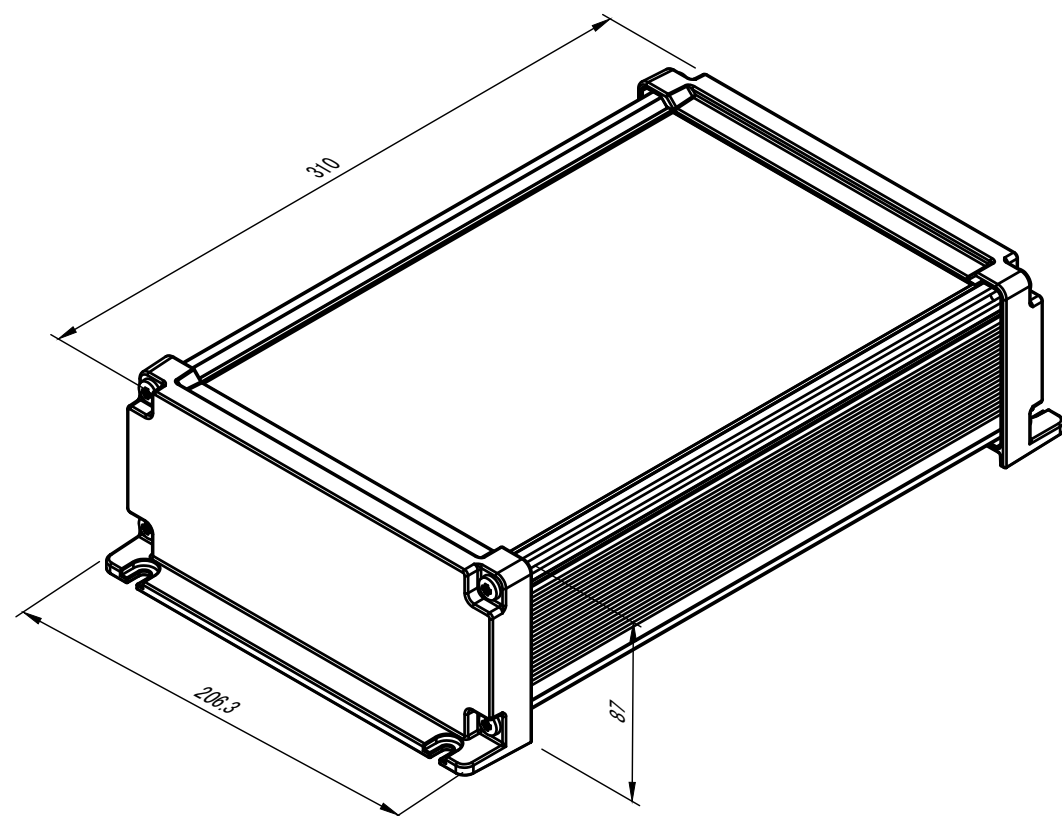

※側板内側は未塗装/The inside of the end panels are unpainted for shielding

本図面および付帯する部品図の著作権は株式会社タカチ電機工業に帰属します。 / Copyright (C) TAKACHI ELECTRONICS ENCLOSURE CO., LTD. All Rights Reserved.

| 色仕様(型番末尾□□)/Color type | | |
|------------------------|-------------|--------------------|
| 記号/Code | パネル/Panel | ボディフレーム/Body frame |
| SS | シルバー/Silver | シルバー/Silver |
| BS | ブラック/Black | シルバー/Silver |
| BB | ブラック/Black | ブラック/Black |

| | | | |
|---|-----------------|---|-------------------|
| TAKACHI 株式会社タカチ電機工業 TAKACHI ELECTRONICS ENCLOSURE CO., LTD. | | 品名/Title フランジ足付防水・防塵アルミケース IP68 FLANGED ALUMINIUM ENCLOSURE | |
| 承認/Approved 中根 | 検図/Checked 王 | 製図/Created 岡本 | |
| 型番/Product number AW21-9-31E□□ | | | 尺度/Scale 1 : 3 |
| 作成日/Date 2023/04/17 | | | 1 / 4 |

フランジ付側板1
Flanged end panel 1

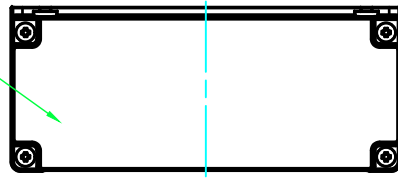

B-B (1:4)

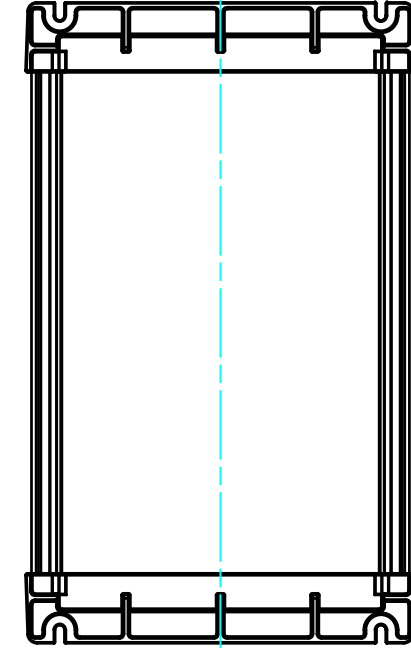
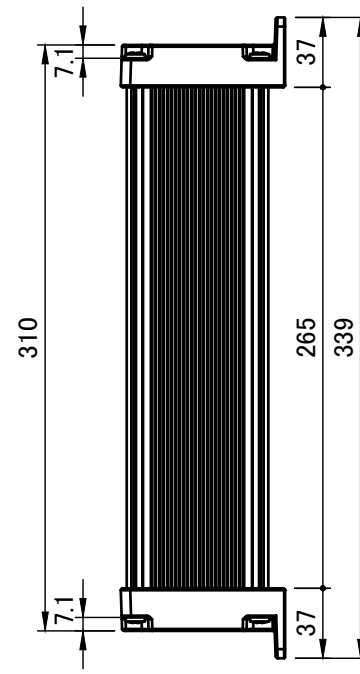
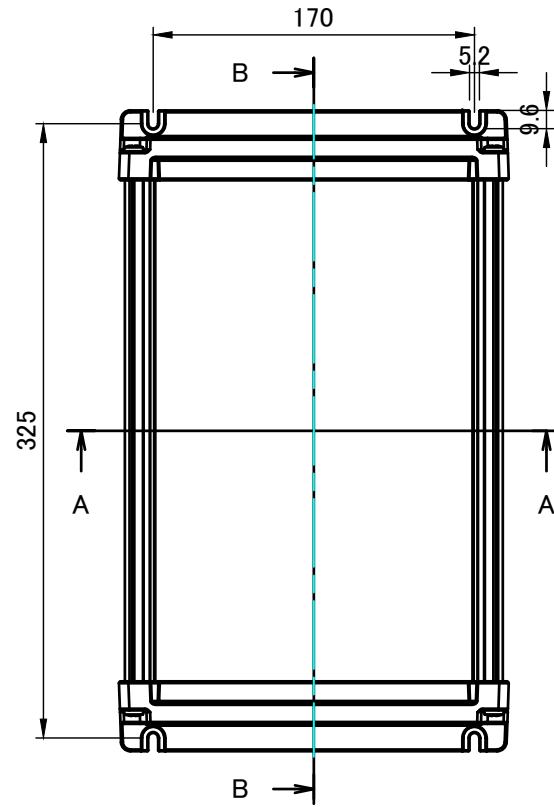
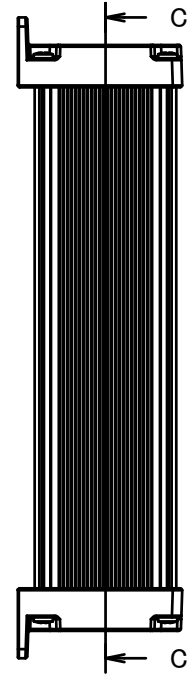
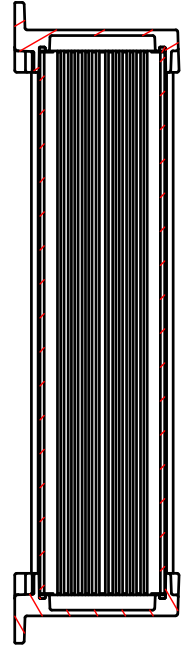

フランジ付側板2
Flanged end panel 2

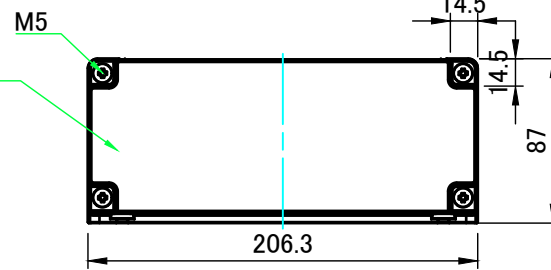

A-A (1:4)

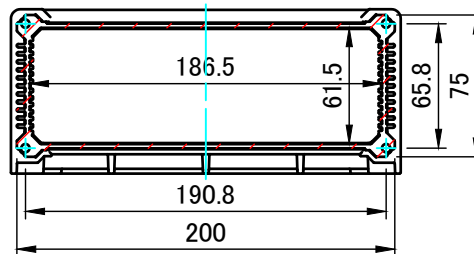

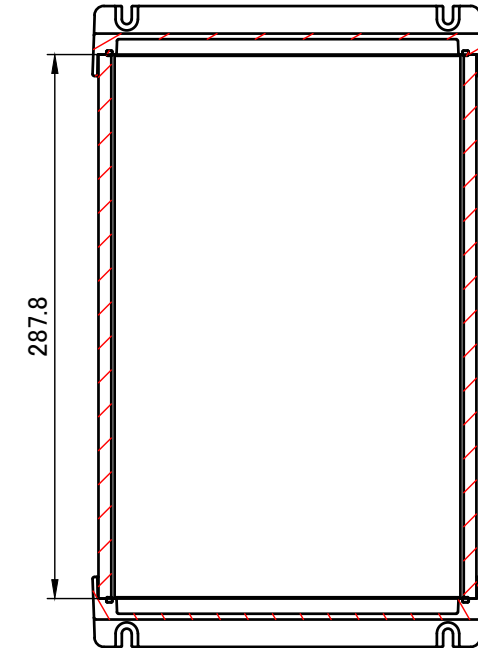

C-C (1:4)

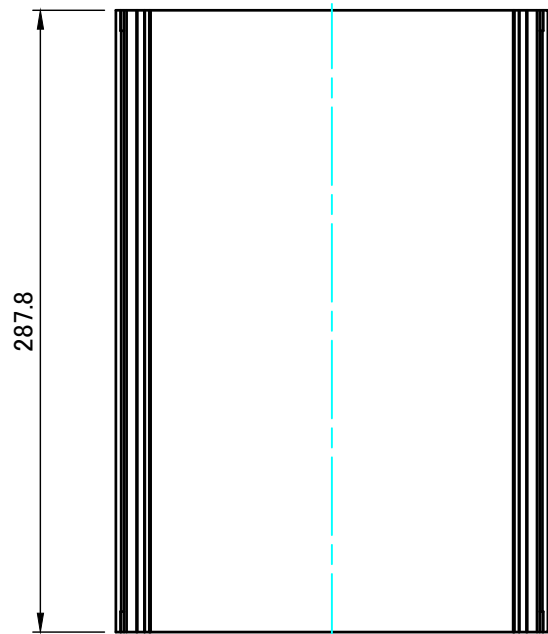
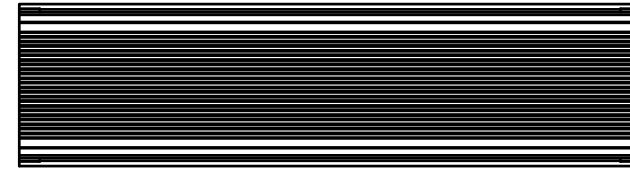
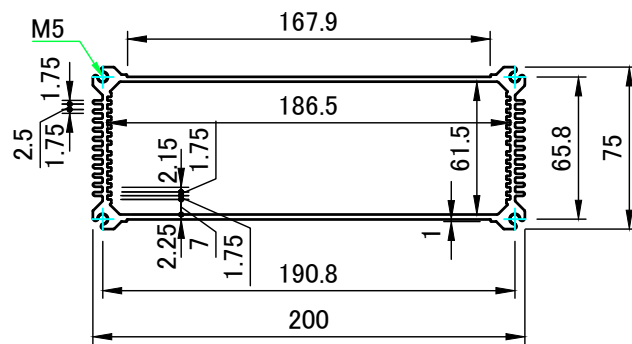
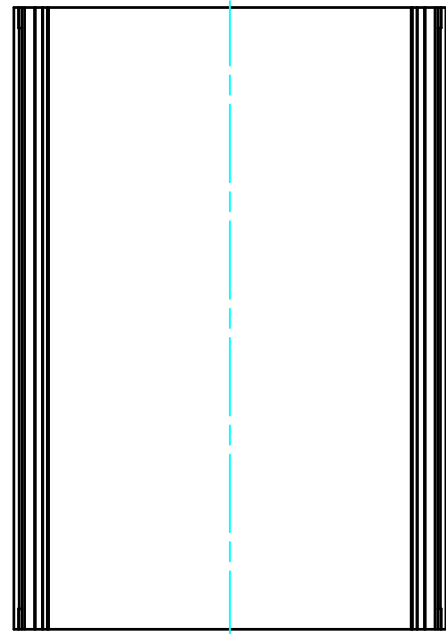
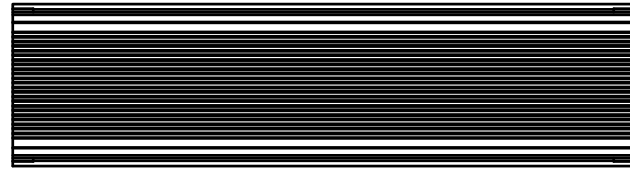

| | | | | |
|---|------------|------------|---|-----------------|
| 株式会社タカチ電機工業 TAKACHI ELECTRONICS ENCLOSURE CO., LTD. | | | 品名/Title フランジ足付防水・防塵アルミケース IP68 FLANGED ALUMINIUM ENCLOSURE | 尺度/Scale 1:4 |
| 承認/Approved | 検図/Checked | 製図/Created | 型番/Product number AW21-9-31E□□ | |
| 中根 | 王 | 岡本 | 作成日/Date 2023/04/17 | 2 / 4 |



| | | | | |
|--|------------|------------|--------------------------------------|---|
|  株式会社タカチ電機工業 TAKACHI ELECTRONICS ENCLOSURE CO., LTD. | | | 品名/Title ボディフレーム Body frame |  |
| 承認/Approved | 検図/Checked | 製図/Created | 型番/Product number W200-H75-D287.8 | 尺度/Scale 1 : 3.5 |
| 中根 | 王 | 岡本 | 作成日/Date 2017/07/18 | 3 / 4 |

フランジ付側板1
Flanged end panel 1

A-A (1:3)

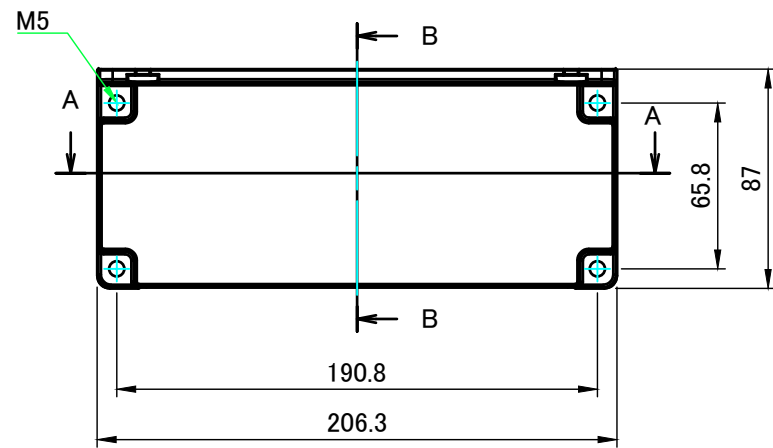
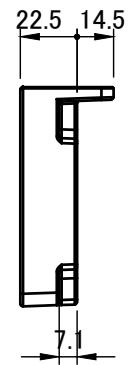
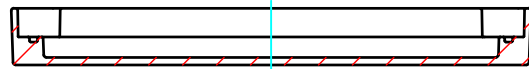

B-B (1:3)

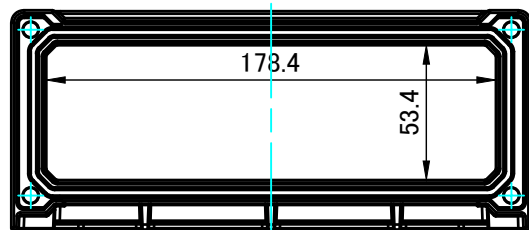
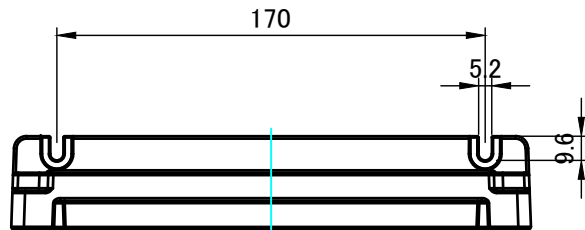
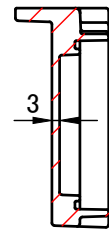

フランジ付側板2
Flanged end panel 2

C-C (1:3)

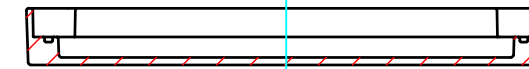

D-D (1:3)

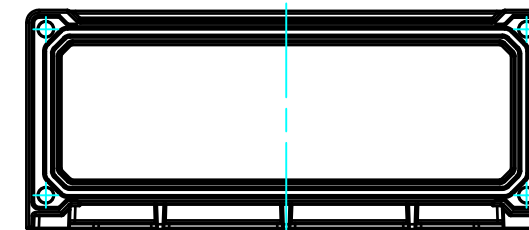
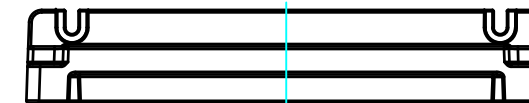
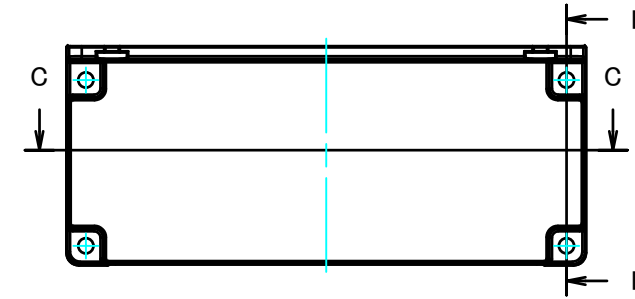
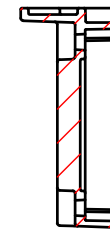

| | | | | |
|---|------------|------------|---|-----------------|
| 株式会社タカチ電機工業 TAKACHI ELECTRONICS ENCLOSURE CO., LTD. | | | 品名/Title フランジ付側板 Flanged end panel | 尺度/Scale 1:3 |
| 承認/Approved | 検図/Checked | 製図/Created | 型番/Product number W200-H75 | |
| 中根 | 王 | 岡本 | 作成日/Date 2017/07/19 | 4 / 4 |