

構成内容 / Components				
No.	名称 / Part name	数量 / Pcs	材質 / Material	色・表面処理 / Color・Finish
1	パネル Panel	2	アルミ板 A1100P Aluminium A1100P	メタリックシルバー・塗装 - 裏面導通処理 Metallic silver・Painted (outside) - Conductive (inside)
2	上カバー Top cover	1	アルミ押出材 A6063S-T5 Extruded aluminium A6063S-T5	メタリックシルバー・塗装 - 内面無処理 Metallic silver・Painted (outside) - Unfinished (inside)
3	下カバー Bottom cover	1	アルミ押出材 A6063S-T5 Extruded aluminium A6063S-T5	メタリックシルバー・塗装 - 内面無処理 Metallic silver・Painted (outside) - Unfinished (inside)
4	フレーム Flanged frame	2	PC + ABS樹脂 (UL94V-0 主成分) PC + ABS Flame-resistant	塗装無 : ブラック, グレー / Black, Gray・Unpainted 塗装付 : ネイビー / Navy・Painted
5	シールドガスケット / Fabric-over-form gasket	2	導電性繊維 TPE / Conductive fabric TPE	メタリックグレー / Metallic gray
6	取付ビス (六角穴付M3×10) Screw (Hexagonal M3-10)	8	ステンレス Stainless steel	無処理 Unfinished

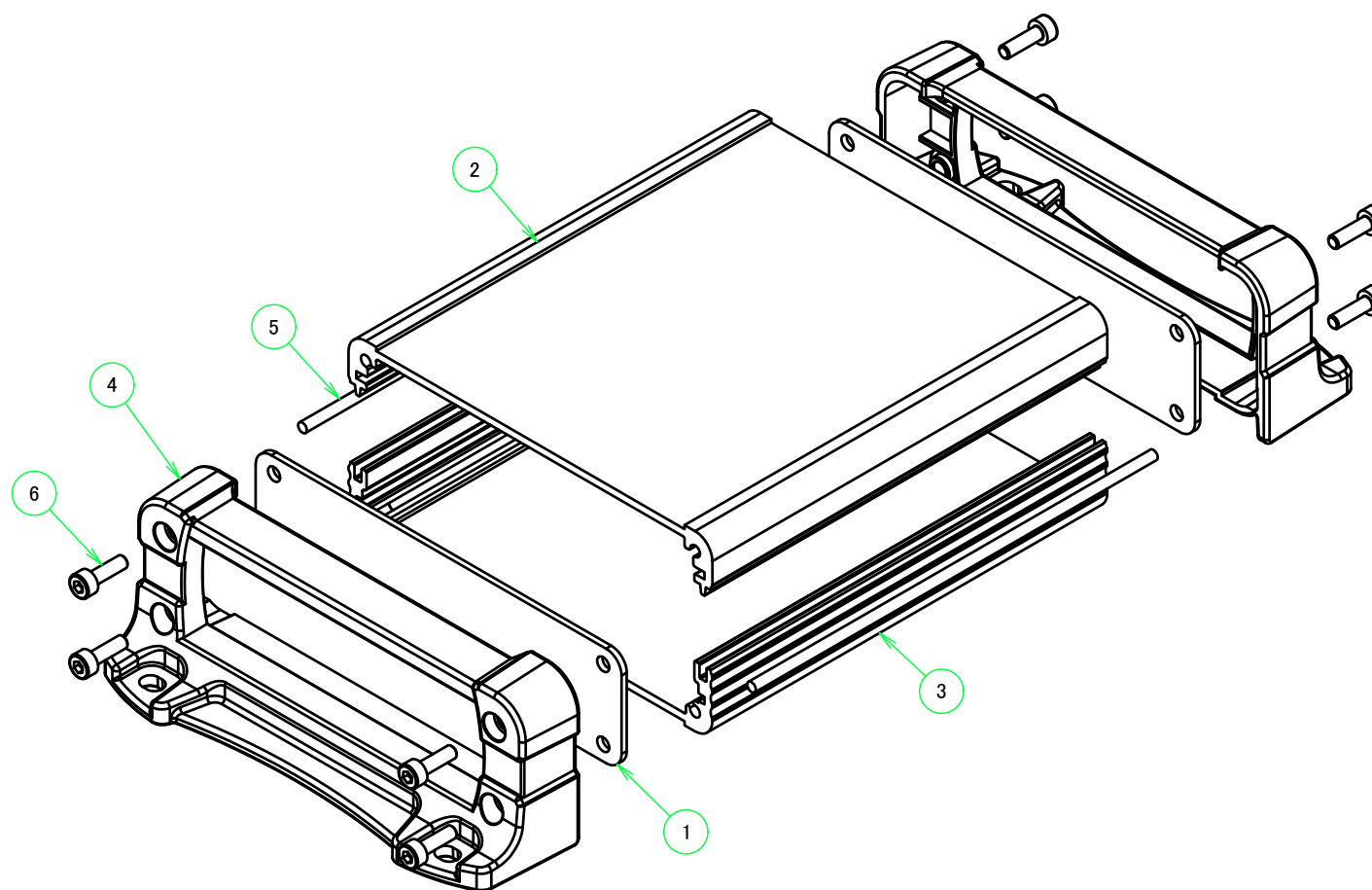
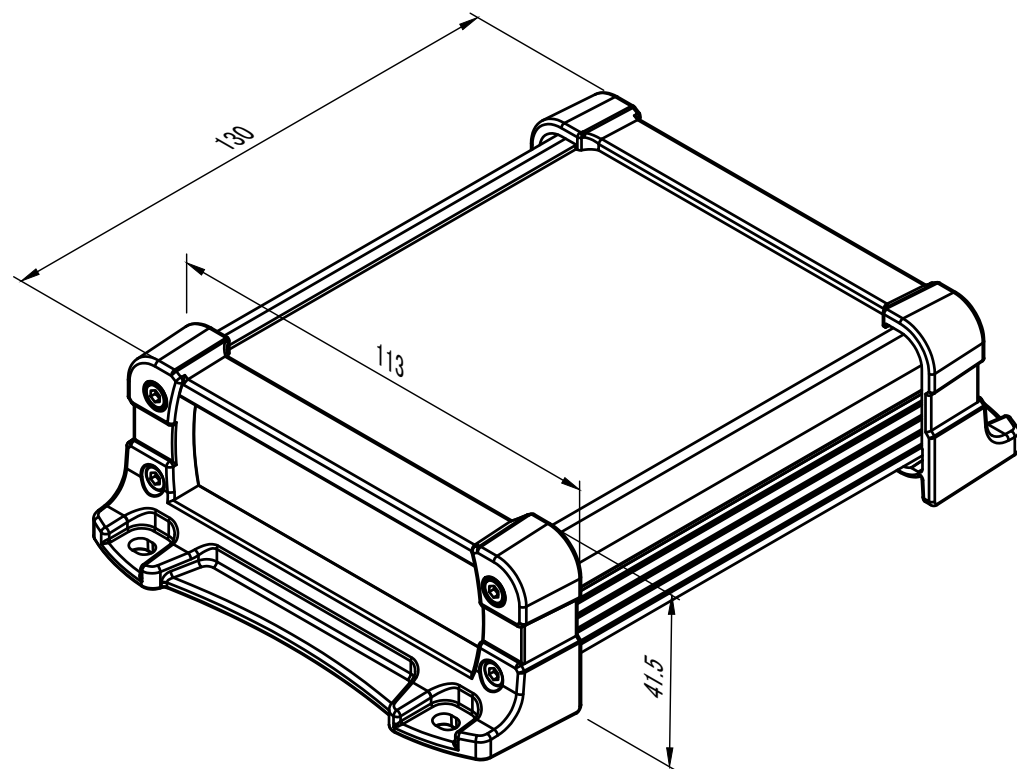

本図面および付帯する部品図の著作権は株式会社タカチ電機工業に帰属します。 / Copyright (C) TAKACHI ELECTRONICS ENCLOSURE CO., LTD. All Rights Reserved.

色仕様(型番末尾□□) / Color type (End of product number□□)		
記号 / Code	上下カバー / Cover	フレーム / Flanged frame
SB	シルバー / Silver	ブラック / Black
SG	シルバー / Silver	グレー / Gray
SN	シルバー / Silver	ネイビー / Navy

株式会社タカチ電機工業 TAKACHI ELECTRONICS ENCLOSURE CO., LTD.			品名/Title フランジ足付アルミケース EMCシールドタイプ FLANGED ALUMINIUM EMC SHIELD CASE	尺度/Scale 1 : 1.5
承認/Approved	検図/Checked	製図/Created	型番/Product number EXEF11-4-13□□	
中根	大江	岡本	作成日/Date 2023/07/10	1 / 5

B-B (1:2.5)

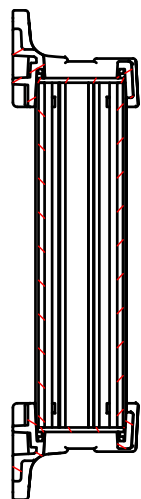

C D

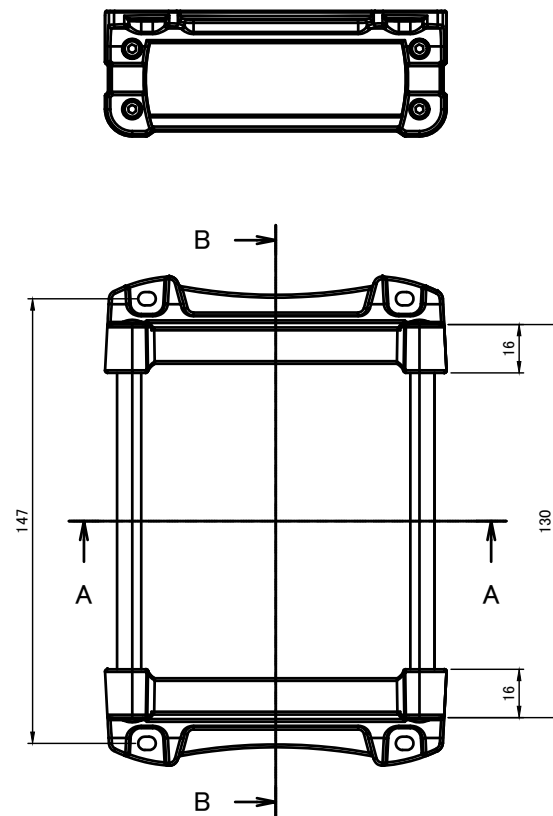
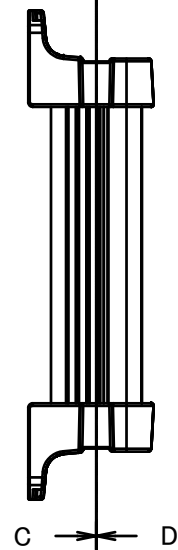

4-M3 六角穴付ボルト
4-M3 Countersunk hole

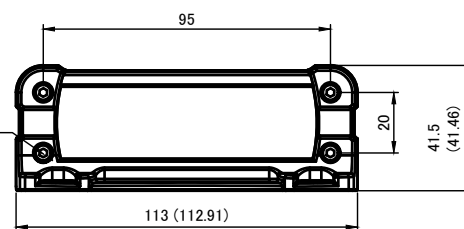

A-A (1:2.5)

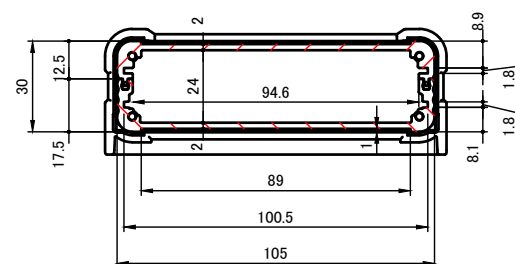

C-C (1:2.5)

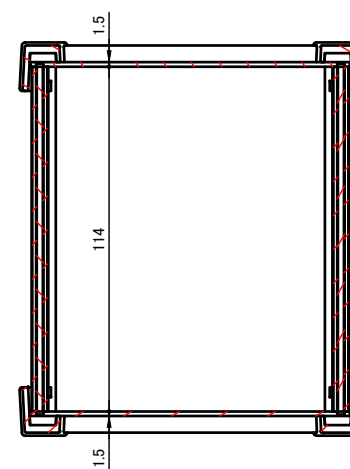

D-D (1:2.5)

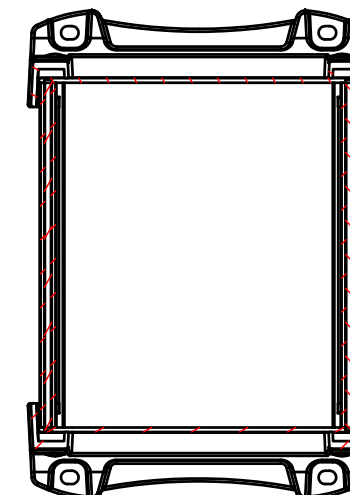

株式会社タカチ電機工業 TAKACHI ELECTRONICS ENCLOSURE CO., LTD.			品名/Title フランジ足付アルミケース EMCシールドタイプ FLANGED ALUMINIUM EMC SHIELD CASE	尺度/Scale 1:2.5
承認/Approved	検図/Checked	製図/Created	型番/Product number EXEF11-4-13□□	
中根	大江	岡本	作成日/Date 2019/04/15	2 / 5

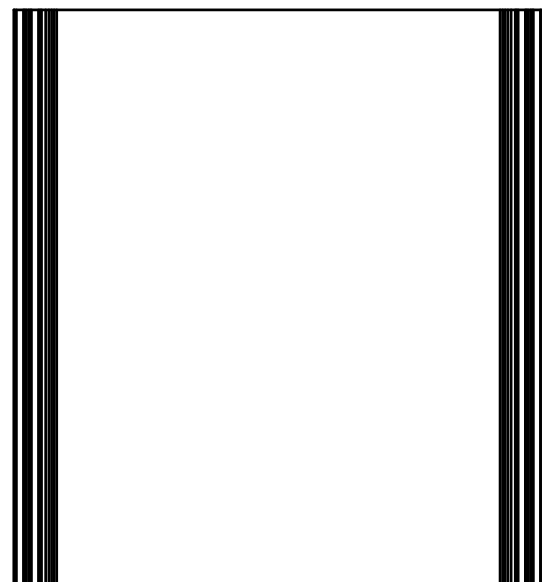
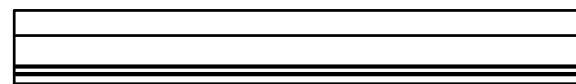
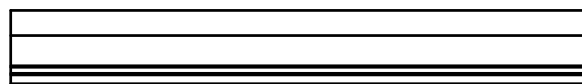
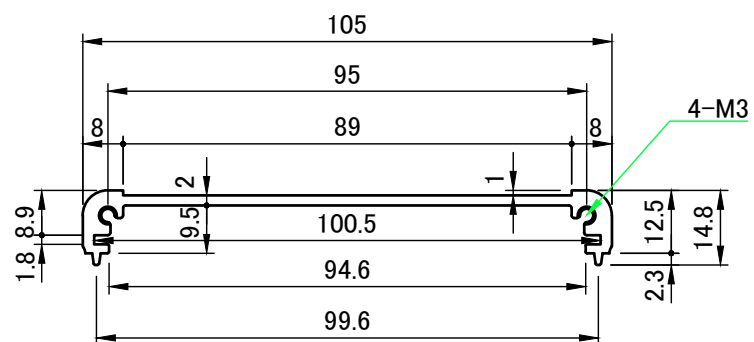
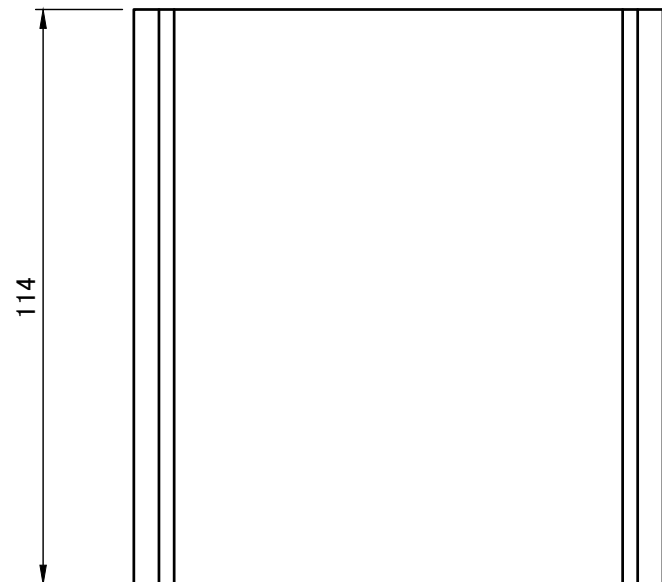

株式会社タカチ電機工業 TAKACHI ELECTRONICS ENCLOSURE CO., LTD.			品名/Title 上カバー TOP COVER	尺度/Scale 1 : 1.5
承認/Approved	検図/Checked	製図/Created	型番/Product number W105-D114	
中根	大江	岡本	作成日/Date 2017/03/15	3 / 5

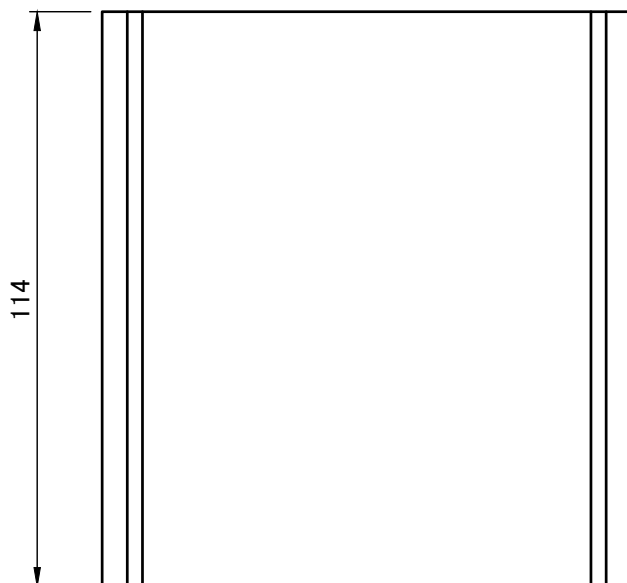
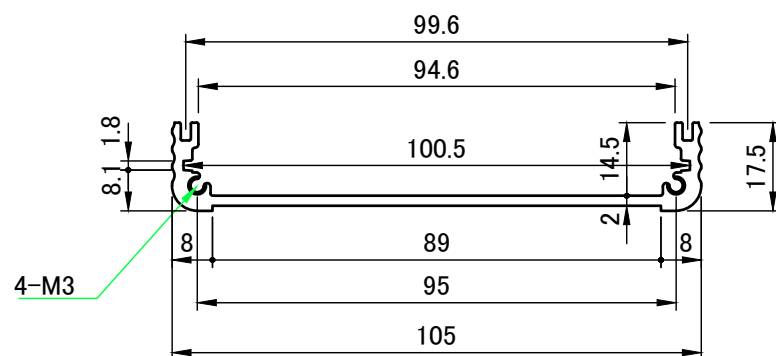
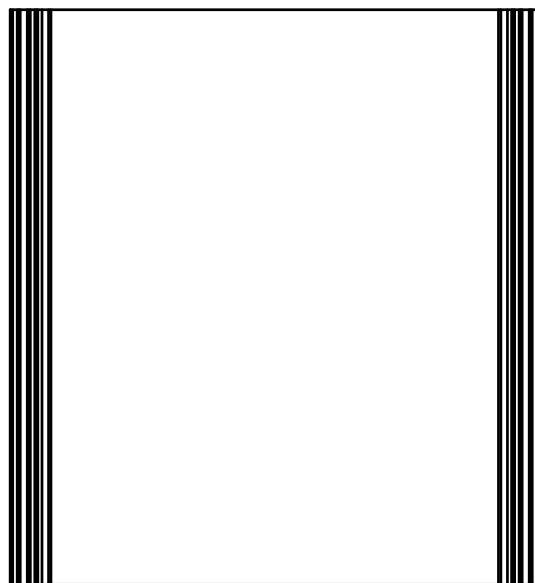

 株式会社タカチ電機工業 TAKACHI ELECTRONICS ENCLOSURE CO., LTD.			品名/Title 下カバー BOTTOM COVER	 尺度/Scale 1 : 1.5
承認/Approved	検図/Checked	製図/Created	型番/Product number W105-H30-D114	
中根	大江	岡本	作成日/Date 2017/03/23	4 / 5

A-A (1:1)

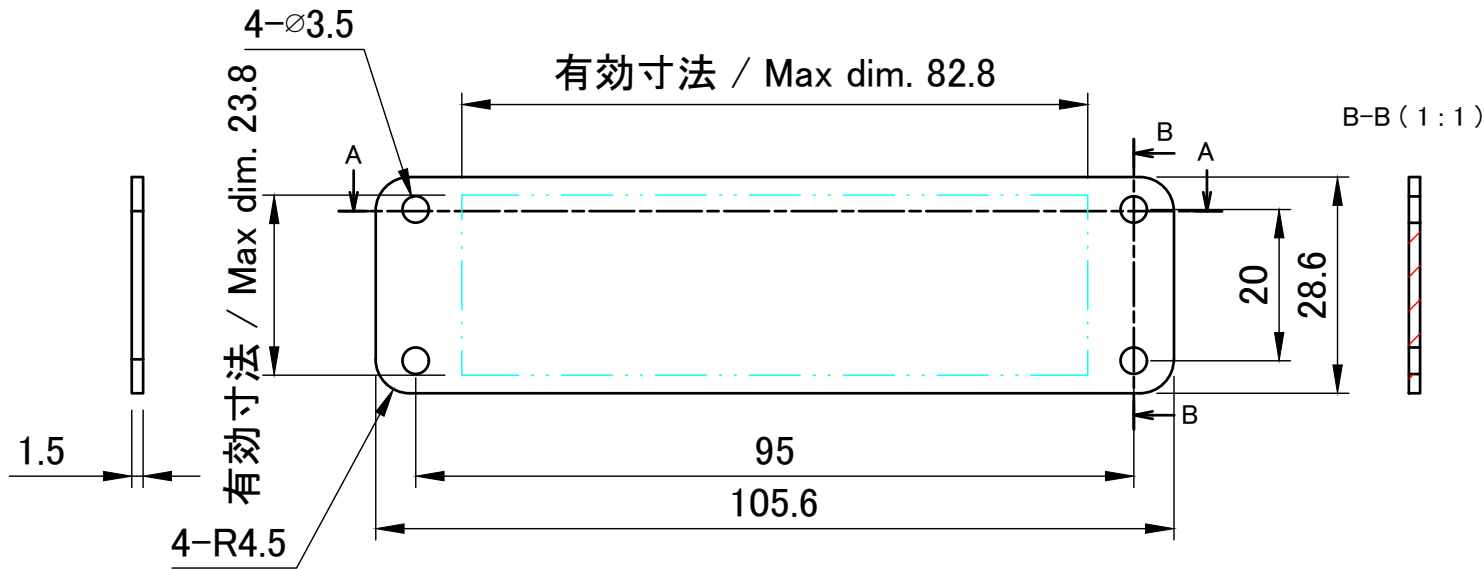
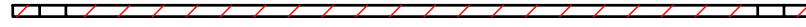

表面 / Outside

保護シート側
Surface protective film side

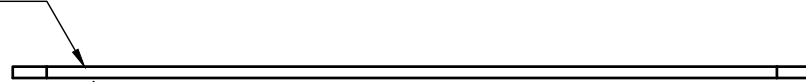

裏面 / Inside

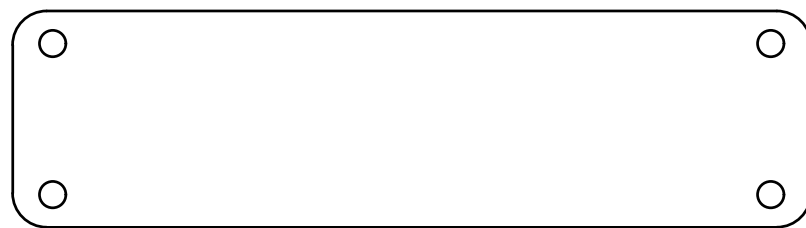

C-C (1:1)

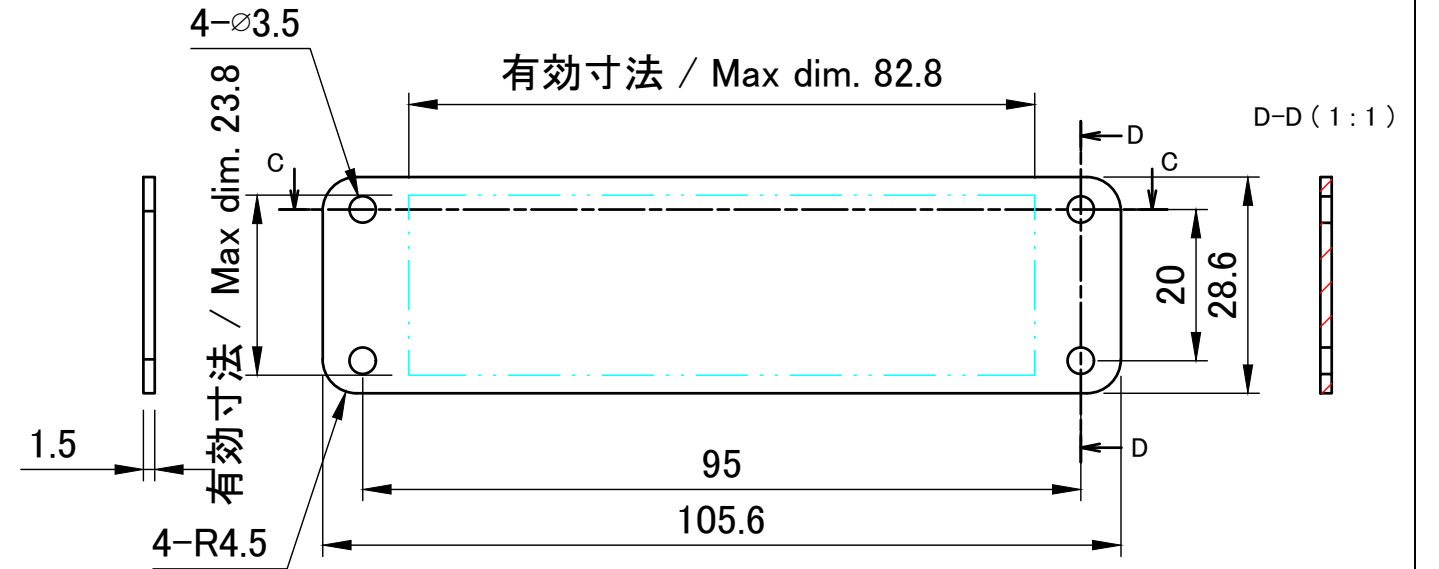

表面 / Outside

保護シート側
Surface protective film side



裏面 / Inside

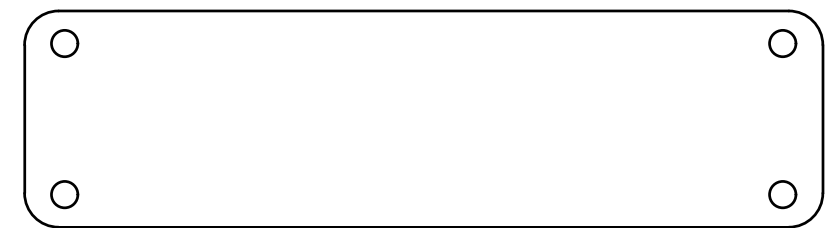

株式会社タカチ電機工業 TAKACHI ELECTRONICS ENCLOSURE CO., LTD.			品名/Title パネル PANEL	
承認/Approved	検図/Checked	製図/Created	型番/Product number W105 - H30	
中根	岡本	大江	作成日/Date 2023/07/10	5 / 5