

| 構成内容 / Components | | | | |
|-------------------|---|----------|--|--|
| No. | 名称 / Part name | 数量 / Pcs | 材質 / Material | 色・表面処理 / Color・Finish |
| 1 | パネル Panel | 2 | アルミ板 A1100P Aluminium A1100P | メタリックシルバー・塗装 - 裏面導通処理 Metallic silver・Painted (outside) - Conductive (inside) |
| 2 | 上カバー Top cover | 1 | アルミ押出材 A6063S-T5 Extruded aluminium A6063S-T5 | メタリックシルバー・塗装 - 内面無処理 Metallic silver・Painted (outside) - Unfinished (inside) |
| 3 | 下カバー Bottom cover | 1 | アルミ押出材 A6063S-T5 Extruded aluminium A6063S-T5 | メタリックシルバー・塗装 - 内面無処理 Metallic silver・Painted (outside) - Unfinished (inside) |
| 4 | フレーム Flanged frame | 2 | PC + ABS樹脂 (UL94V-0 主成分) PC + ABS Flame-resistant | 塗装無 : ブラック, グレー / Black, Gray・Unpainted 塗装付 : ネイビー / Navy・Painted |
| 5 | シールドガスケット / Fabric-over-form gasket | 2 | 導電性繊維 TPE / Conductive fabric TPE | メタリックグレー / Metallic gray |
| 6 | 取付ビス (六角穴付M5×12) Screw (Hexagonal M5-12) | 8 | ステンレス Stainless steel | 無処理 Unfinished |

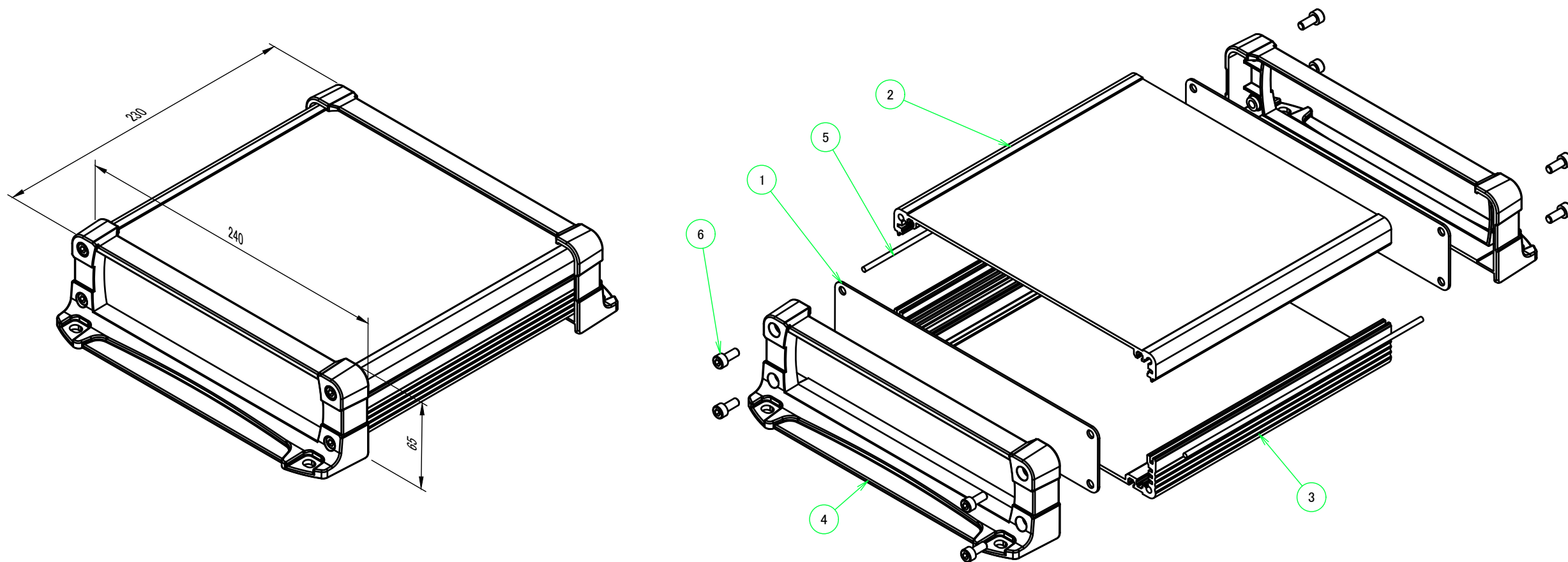

本図面および付帯する部品図の著作権は株式会社タカチ電機工業に帰属します。 / Copyright (C) TAKACHI ELECTRONICS ENCLOSURE CO., LTD. All Rights Reserved.

| 色仕様(型番末尾□□) / Color type | | |
|--------------------------|---------------|----------------------|
| 記号 / Code | 上下カバー / Cover | フレーム / Flanged frame |
| SB | シルバー / Silver | ブラック / Black |
| SG | シルバー / Silver | グレー / Gray |
| SN | シルバー / Silver | ネイビー / Navy |

| | | | |
|---|------------------|--|-----------------|
| TAKACHI 株式会社タカチ電機工業 TAKACHI ELECTRONICS ENCLOSURE CO., LTD. | | 品名/Title フランジ足付アルミケース EMCシールドタイプ FLANGED ALUMINIUM EMC SHIELD CASE | |
| 承認/Approved 中根 | 検図/Checked 岡本 | 製図/Created 大江 | |
| 型番/Product number EXEF24-7-23□□ | | | 尺度/Scale 1:3 |
| 作成日/Date 2023/07/10 | | | 1 / 5 |

B-B (1:4)

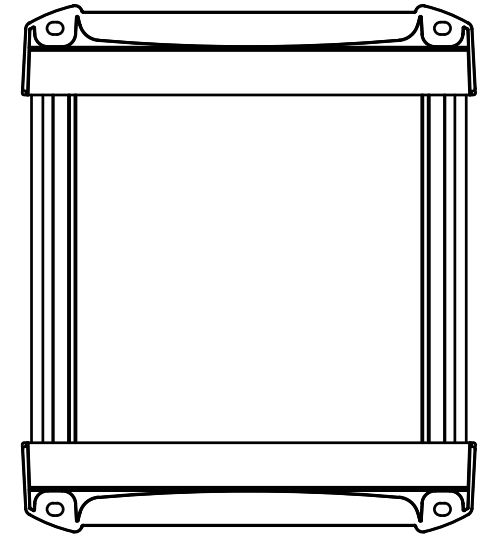
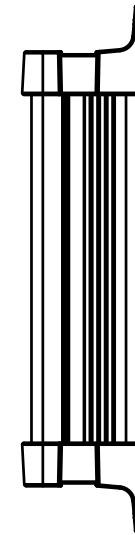
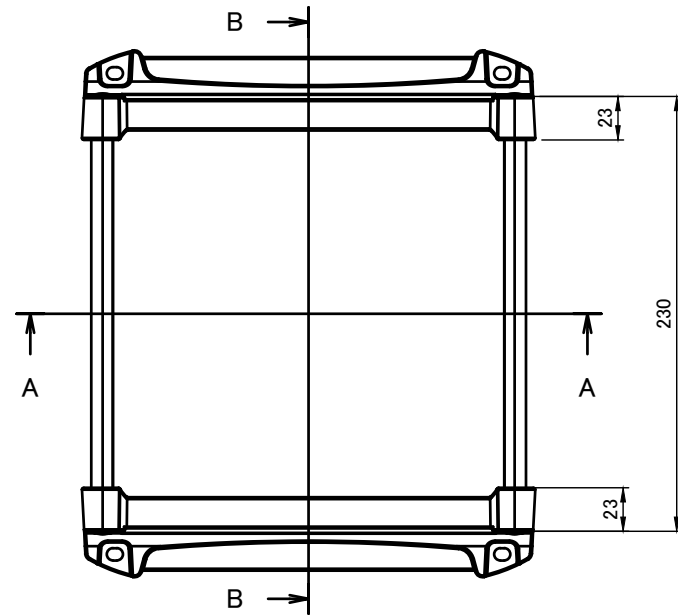
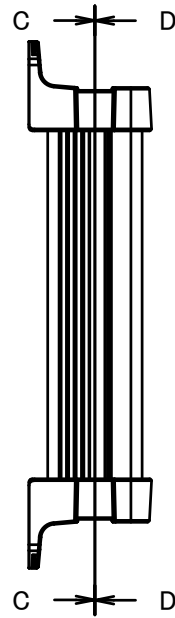
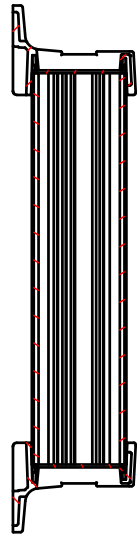

4-M5 六角穴付ボルト
4-M5 Countersunk hole

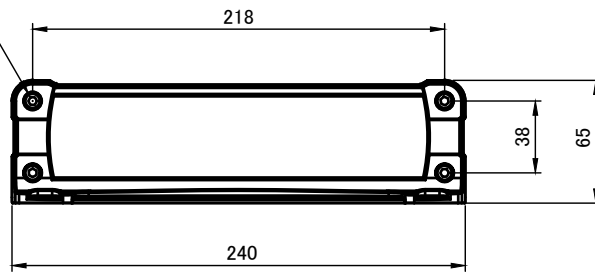

C-C (1:4)

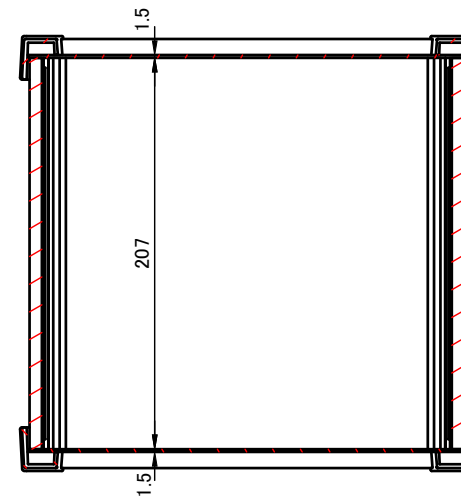

D-D (1:4)

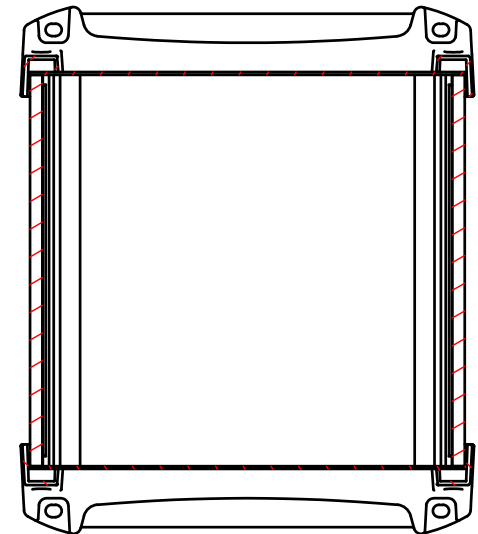

A-A (1:4)

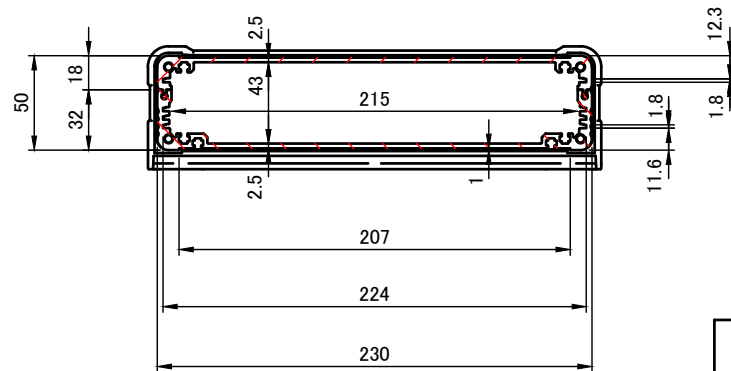

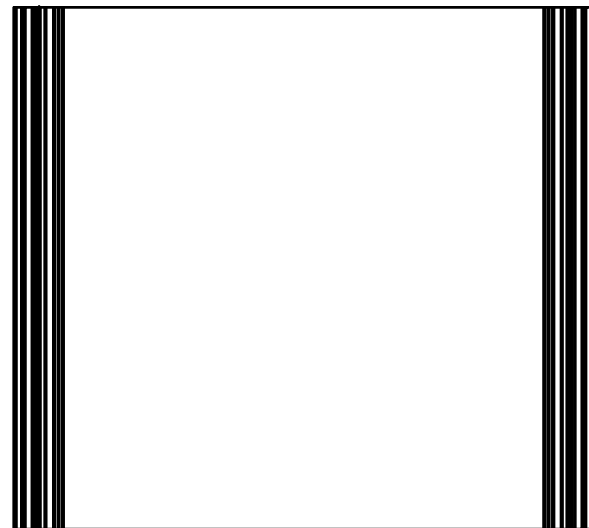
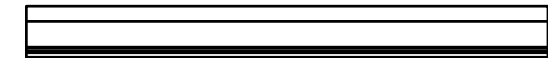
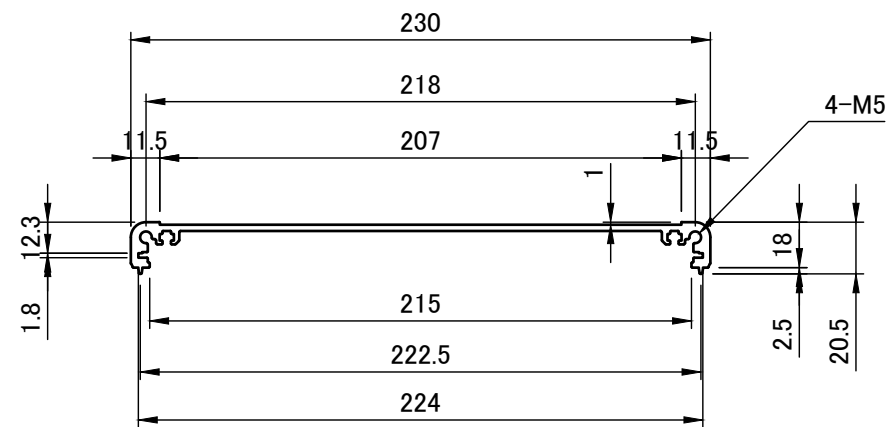
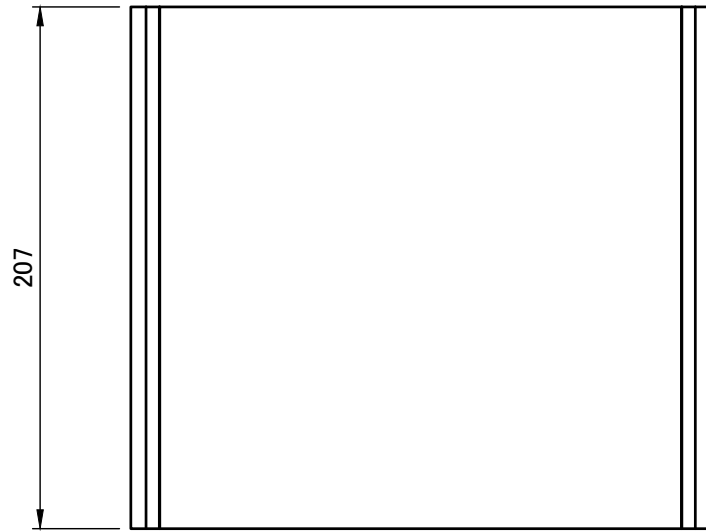
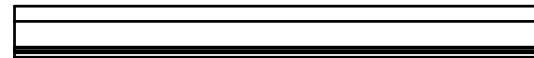

| | | | | |
|---|------------|------------|--|-----------------|
| 株式会社タカチ電機工業 TAKACHI ELECTRONICS ENCLOSURE CO., LTD. | | | 品名/Title フランジ足付アルミケース EMCシールドタイプ FLANGED ALUMINIUM EMC SHIELD CASE | 尺度/Scale 1:4 |
| 承認/Approved | 検図/Checked | 製図/Created | 型番/Product number EXEF24-7-23□□ | |
| 中根 | 岡本 | 大江 | 作成日/Date 2019/02/20 | 2 / 5 |

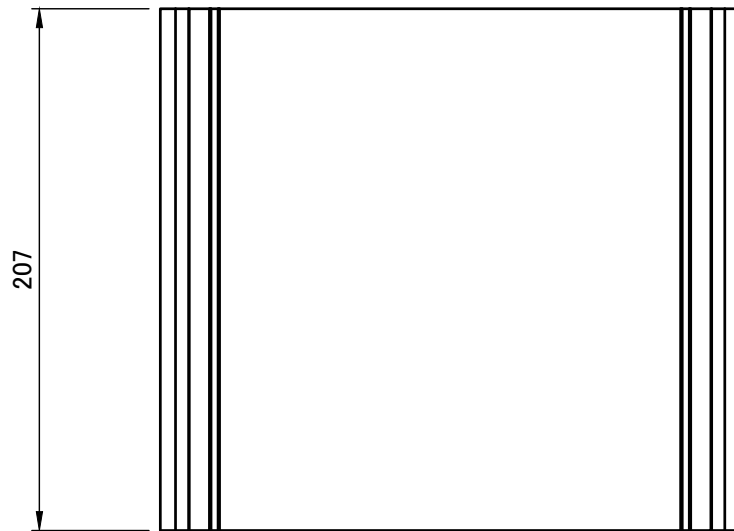
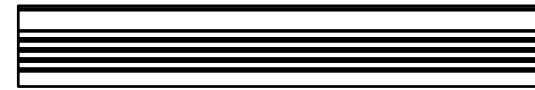
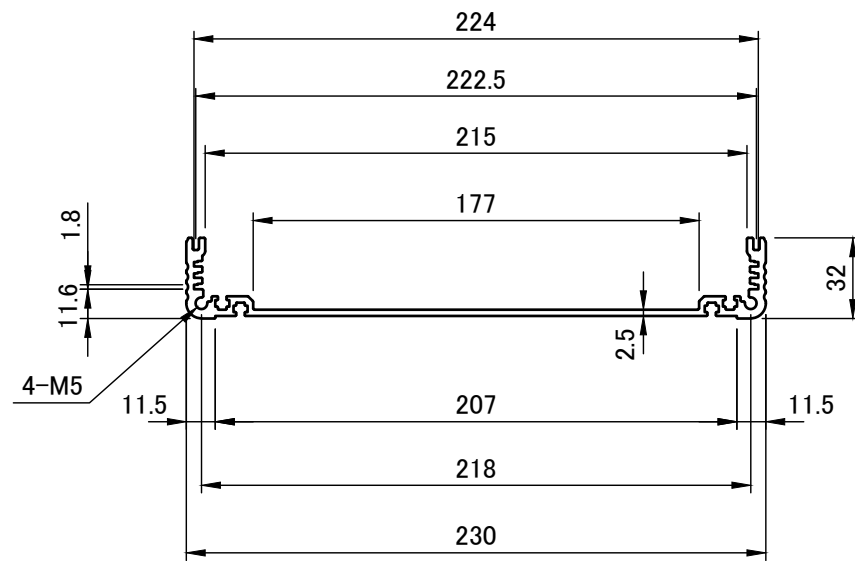
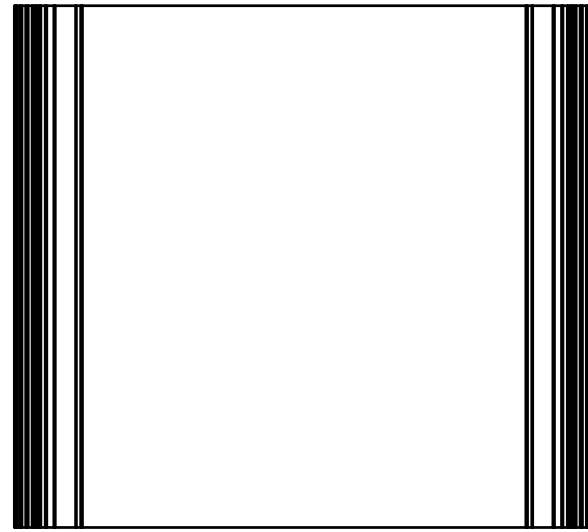
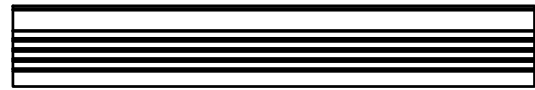

| | | | | |
|---|------------|------------|---------------------------------------|--|
|  株式会社タカチ電機工業 TAKACHI ELECTRONICS ENCLOSURE CO., LTD. | | | 品名/Title 上カバー TOP COVER |  尺度/Scale 1:3 |
| 承認/Approved | 検図/Checked | 製図/Created | 型番/Product number W230-D207 | |
| 中根 | 岡本 | 大江 | 作成日/Date 2019/01/15 | 3 / 5 |



| | | | | |
|--|------------|------------|------------------------------------|--|
|  株式会社タカチ電機工業 TAKACHI ELECTRONICS ENCLOSURE CO., LTD. | | | 品名/Title 下カバー BOTTOM COVER |  尺度/Scale 1:3 |
| 承認/Approved | 検図/Checked | 製図/Created | 型番/Product number W230-H50-D207 | |
| 中根 | 岡本 | 大江 | 作成日/Date 2019/01/15 | 4 / 5 |

A-A (1:3)

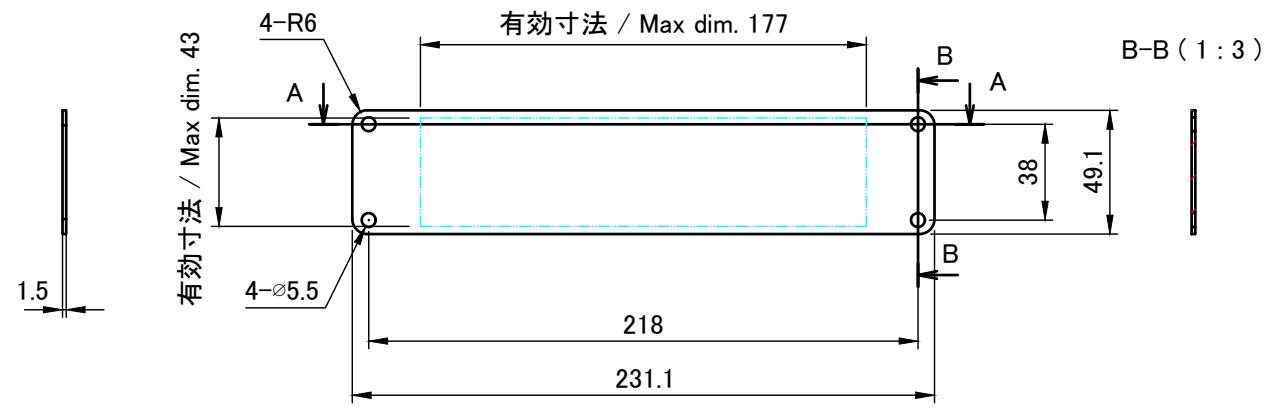

表面 / Outside

保護シート側
Surface protective film side

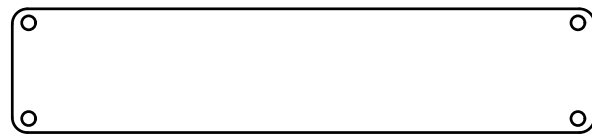

裏面 / Inside

C-C (1:3)

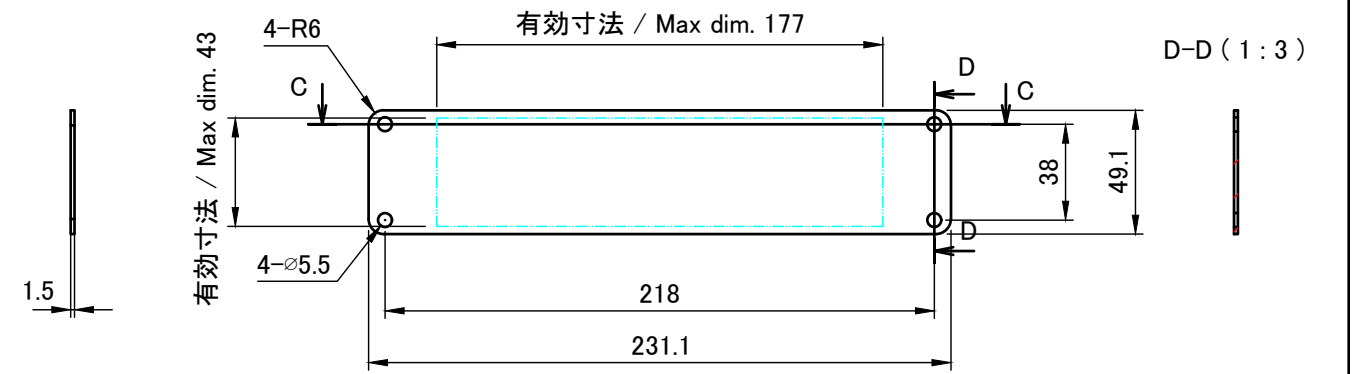

表面 / Outside

保護シート側
Surface protective film side

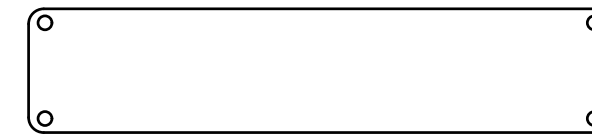

裏面 / Inside

| | | | | |
|--|------------|------------|-------------------------------|-----------------|
| 株式会社タカチ電機工業 TAKACHI ELECTRONICS ENCLOSURE CO., LTD. | | | 品名/Title パネル PANEL | 尺度/Scale 1:3 |
| 承認/Approved | 検図/Checked | 製図/Created | 型番/Product number W230-H50 | |
| 中根 | 岡本 | 大江 | 作成日/Date 2023/07/10 | 5 / 5 |