

構成内容 / Components				
No.	名称 / Part name	数量 / Pcs	材質 / Material	色・表面処理 / Color・Finish
1	パネル Panel	2	アルミ板 A1050P Aluminium A1050P	メタリックシルバー・表面塗装-裏面無処理,ブラックアルマイト Metallic Silver・Painted (Unfinished inside),Black anodized
2	ヒートシンクカバー Heat-sink top cover	1	アルミ押出材 Extruded aluminium A6063S-T5	メタリックシルバー・表面塗装-内面無処理,ブラックアルマイト Metallic Silver・Painted (Unfinished inside),Black anodized
3	下カバー Bottom frame	1	アルミ押出材 Extruded aluminium A6063S-T5	メタリックシルバー・表面塗装-内面無処理,ブラックアルマイト Metallic Silver・Painted (Unfinished inside),Black anodized
4	取付ビス(M5×10皿六角穴付) / Screw	8	ステンレス / Stainless steel	無処理 / Unfinished
5	ゴム足 / Rubber feet	4	合成ゴム / Rubber	ブラック / Black

※ゴム足は任意の場所に貼り付けできます。
※Adhesive rubber feet included.

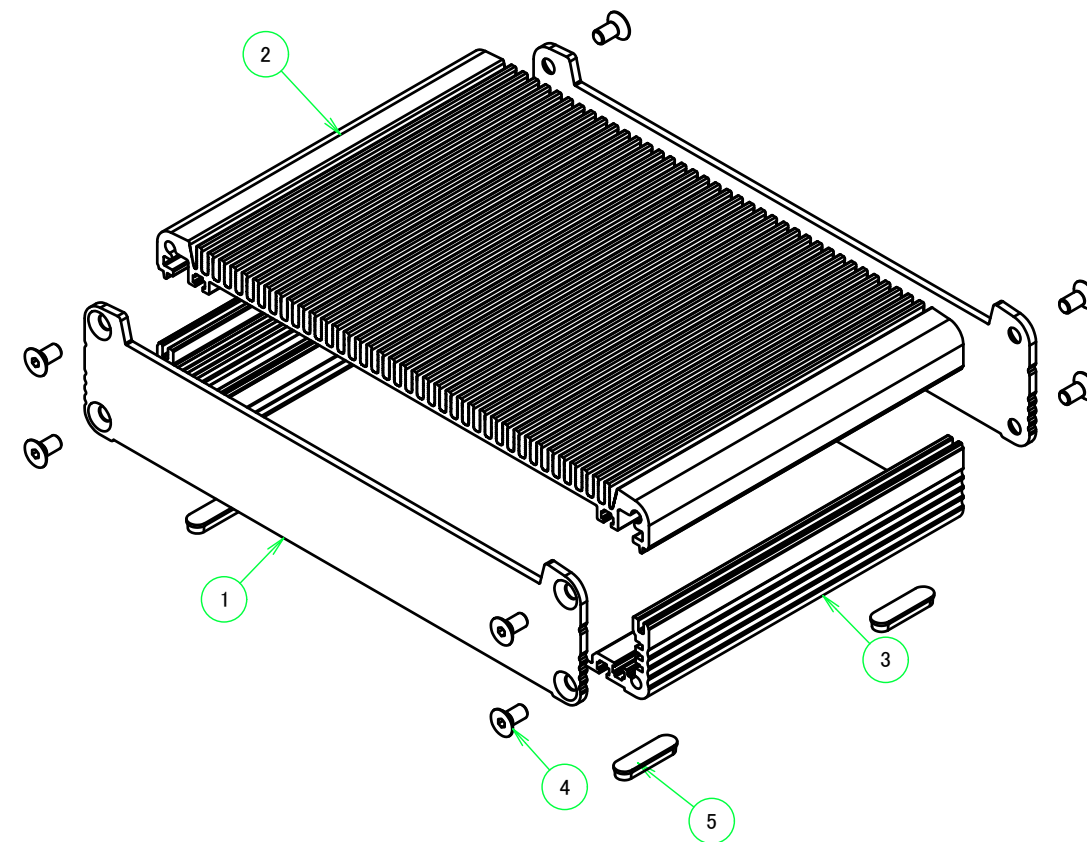
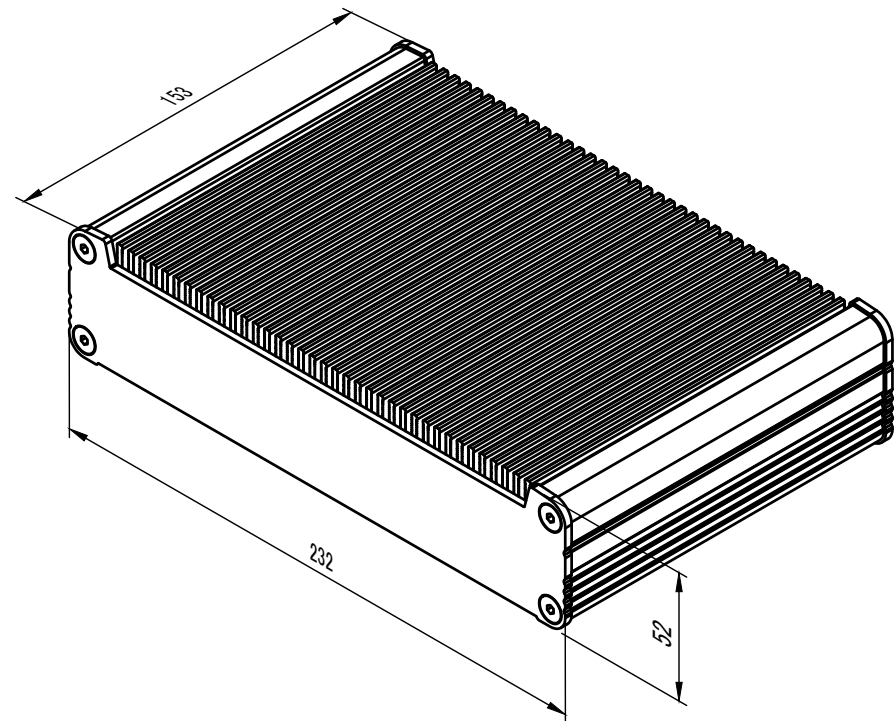

本図面および付帯する部品図の著作権は株式会社タカチ電機工業に帰属します。 / Copyright (C) TAKACHI ELECTRONICS ENCLOSURE CO., LTD. All Rights Reserved.

色仕様(型番末尾口)/Color type		
記号/Code	ヒートシンク・下カバー/Cover	パネル/Panel
SS	シルバー/Silver	シルバー/Silver
BB	ブラック/Black	ブラック/Black

株式会社タカチ電機工業 TAKACHI ELECTRONICS ENCLOSURE CO., LTD.		品名/Title ヒートシンクアルミケース HEAT-SINK ALUMINIUM ENCLOSURE	
承認/Approved	検図/Checked	製図/Created	型番/Product number EXH23-5-15□□
中根	大江	岡本	作成日/Date 2022/11/30
			尺度/Scale 1 : 2.5 1 / 5

ゴム足
Rubber feet

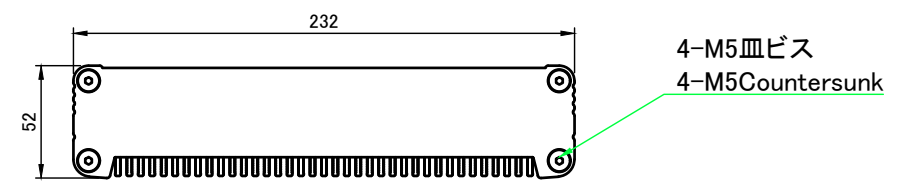
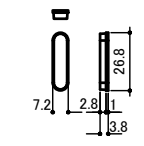

B-B (1:3.5)

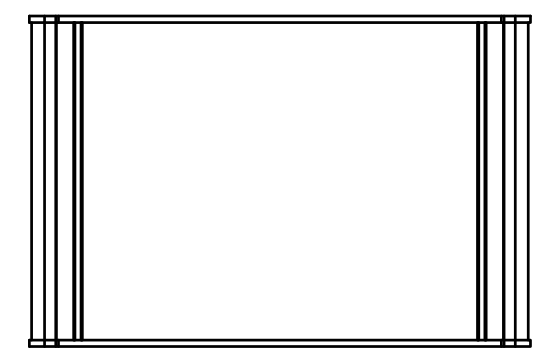
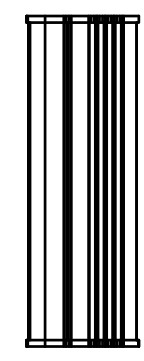
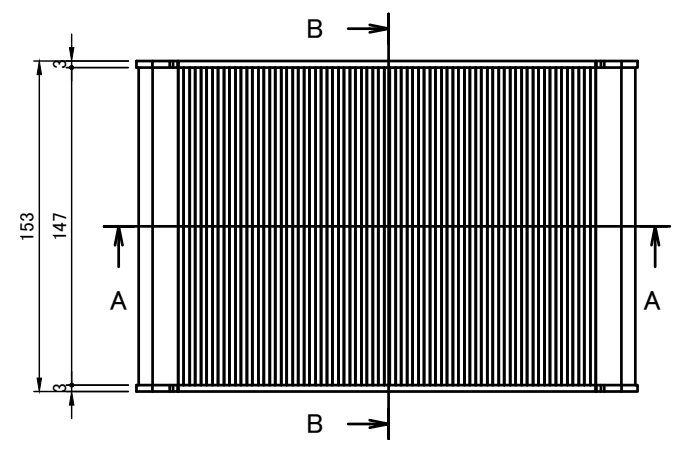
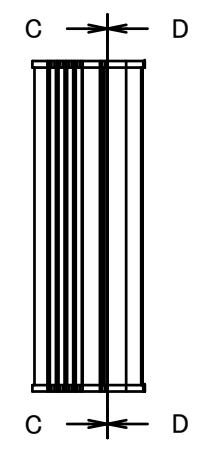
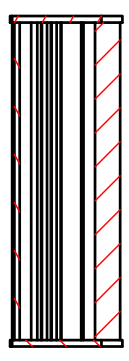

C-C (1:3.5)

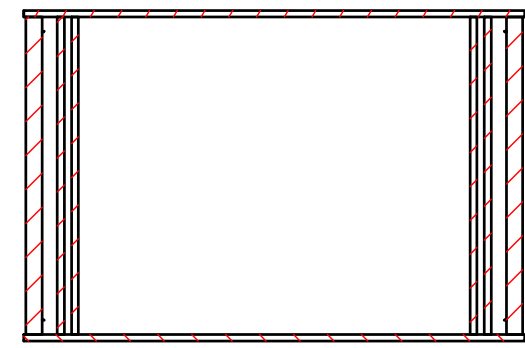

D-D (1:3.5)

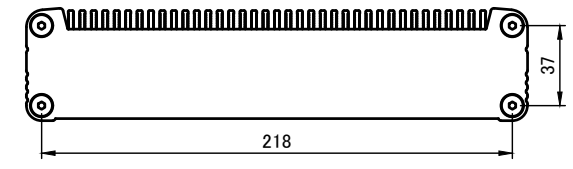
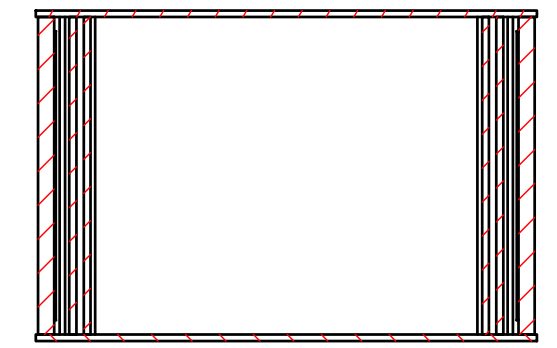

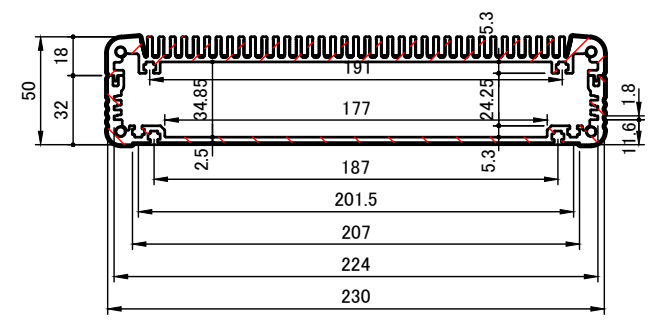

A-A (1:3.5)

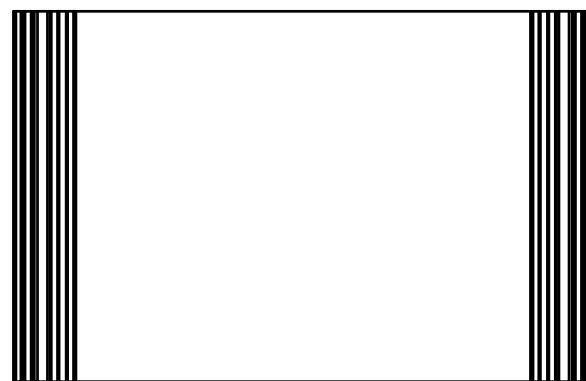
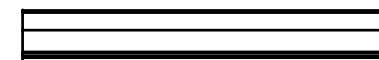
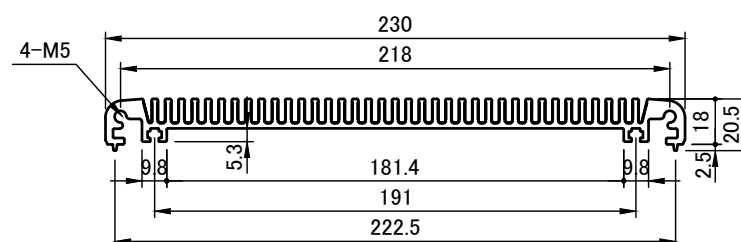
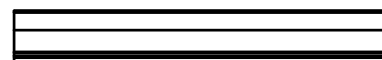
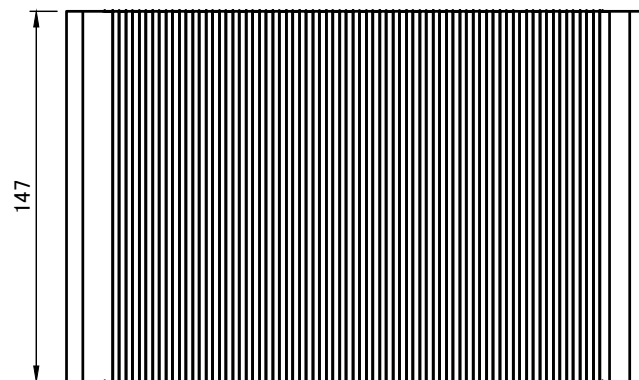

株式会社タカチ電機工業 TAKACHI ELECTRONICS ENCLOSURE CO., LTD.			品名/Title ヒートシンクアルミケース HEAT-SINK ALUMINIUM ENCLOSURE	尺度/Scale 1:3.5
承認/Approved 中根	検図/Checked 大江	製図/Created 岡本	型番/Product number EXH23-5-15□□	
			作成日/Date 2022/04/01	2 / 5

ヒートシンク / Heat-sink top cover



 株式会社タカチ電機工業 TAKACHI ELECTRONICS ENCLOSURE CO., LTD.		品名/Title ヒートシンクアルミケース HEAT-SINK ALUMINIUM ENCLOSURE	 尺度/Scale 1 : 3
承認/Approved 中根	検図/Checked 大江	製図/Created 岡本	
			作成日/Date 2019/02/12
			3 / 5

下カバー / Bottom frame

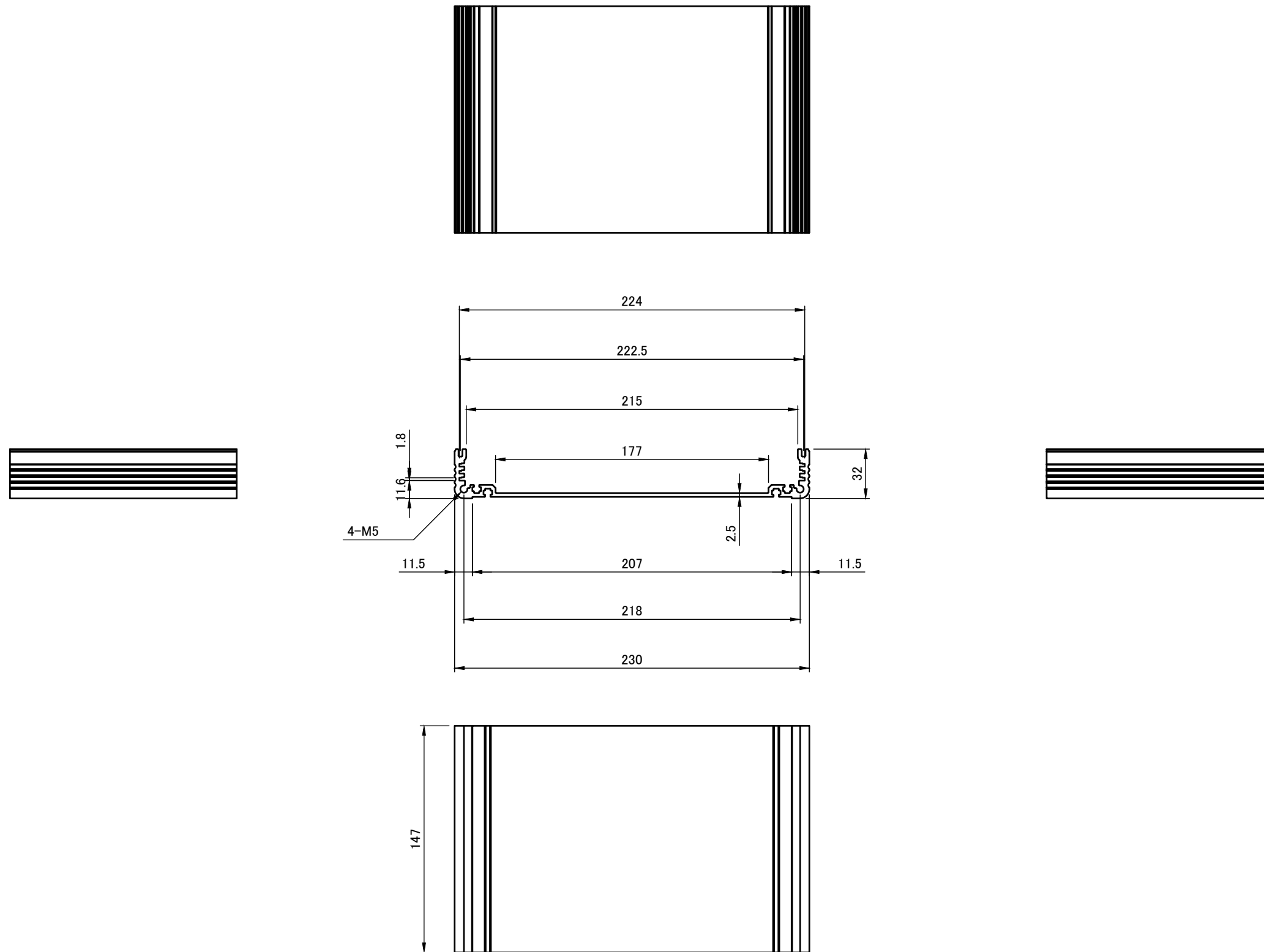

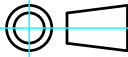
 株式会社タカチ電機工業 TAKACHI ELECTRONICS ENCLOSURE CO., LTD.			品名/Title 下カバー BOTTOM COVER	 尺度/Scale 1:3
承認/Approved	検図/Checked	製図/Created	型番/Product number W230-H50-D147	
中根	岡本	大江	作成日/Date 2019/01/15	4 / 5

パネル / Panel

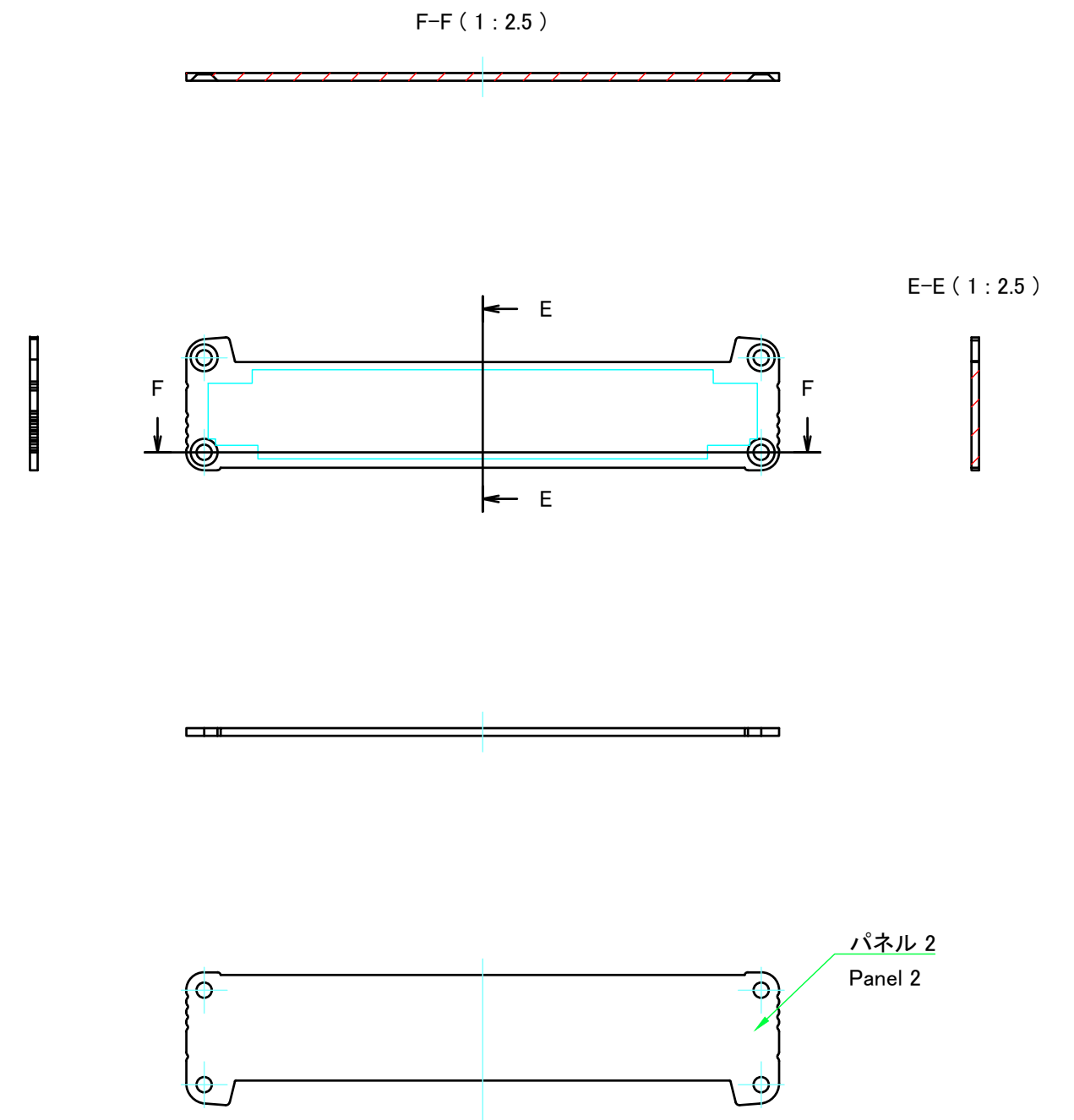
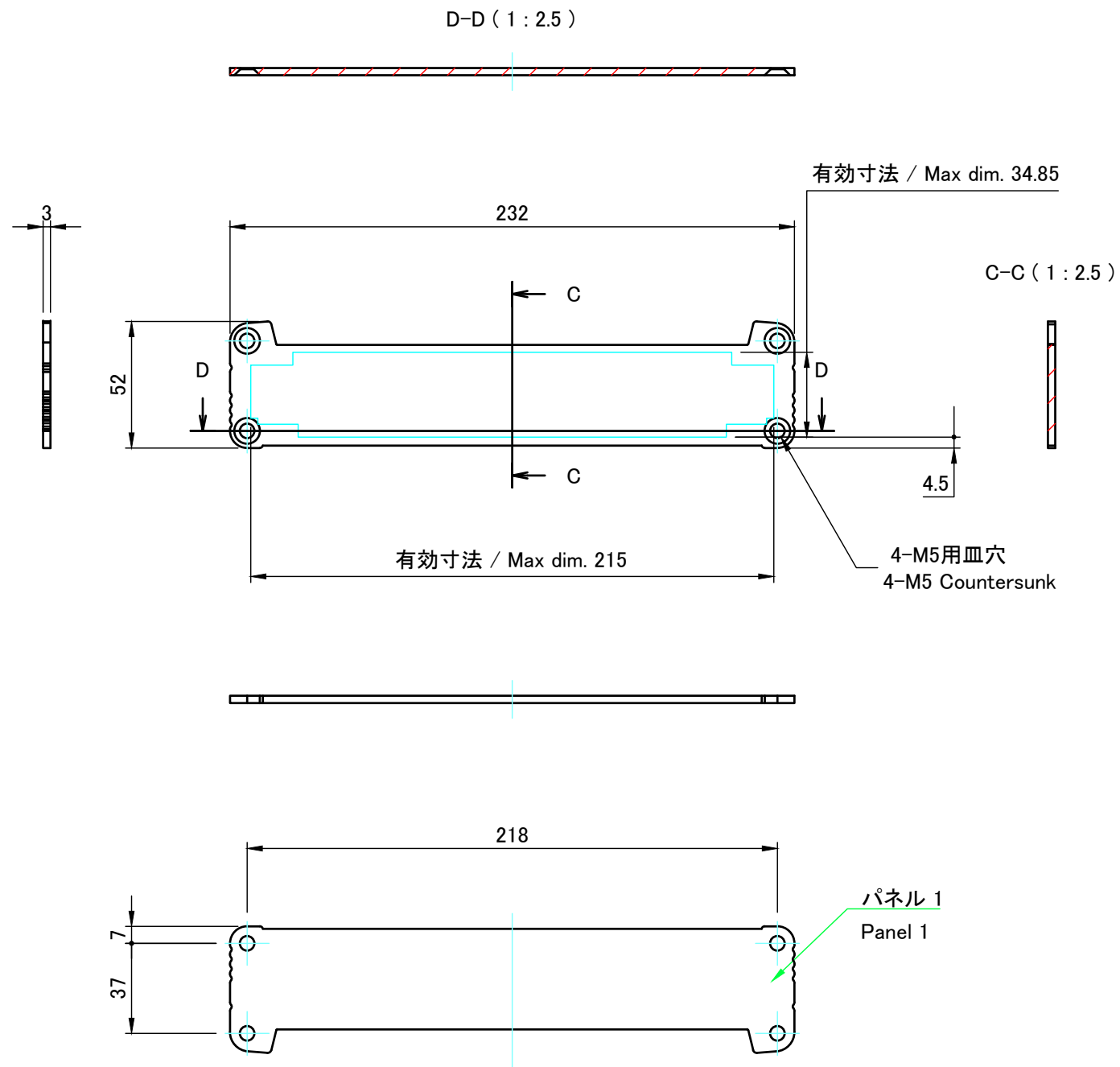

株式会社タカチ電機工業 TAKACHI ELECTRONICS ENCLOSURE CO., LTD.			品名/Title パネル PANEL	尺度/Scale 1:2.5
承認/Approved	検図/Checked	製図/Created	型番/Product number W232 - H52	
中根	岡本	野村	作成日/Date 2023/02/02	5 / 5