

構成内容 / Components				
No.	名称 / Part name	数量 / Pcs	材質 / Material	色・表面処理 / Color・Finish
1	フランジパネル Flanged panel	2	アルミ板 A1050P Aluminium A1050P	メタリックシルバー・表面塗装・裏面無処理、ブラックアルマイト Metallic Silver・Painted (Unfinished inside), Black anodized
2	ヒートシンクカバー Heat-sink top cover	1	アルミ押出材 A6063S-T5 Extruded aluminium A6063S-T5	メタリックシルバー・表面塗装・内面無処理、ブラックアルマイト Metallic Silver・Painted (Unfinished inside), Black anodized
3	下カバー Bottom frame	1	アルミ押出材 A6063S-T5 Extruded aluminium A6063S-T5	メタリックシルバー・表面塗装・内面無処理、ブラックアルマイト Metallic Silver・Painted (Unfinished inside), Black anodized
4	取付ビス(六角穴付皿 M3×8) Screw ( Hexagonal M3-8 )	8	ステンレス Stainless steel	無処理 Unfinished
5	差込ゴム足 / Rubber feet	4	シリコンゴム / Silicone	ブラック / Black

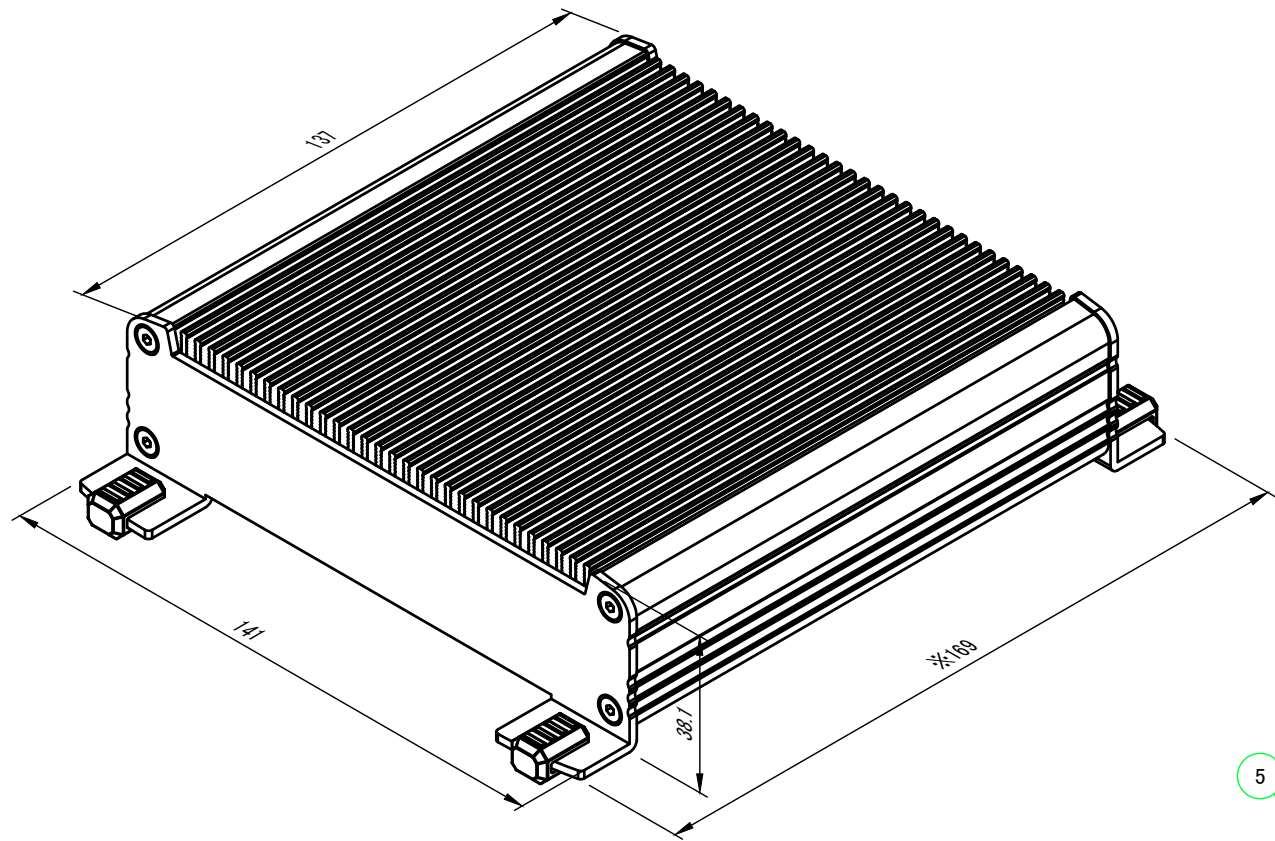

※ゴム足寸法は含んでおりません。  
※Rubber feet dimensions are not included.

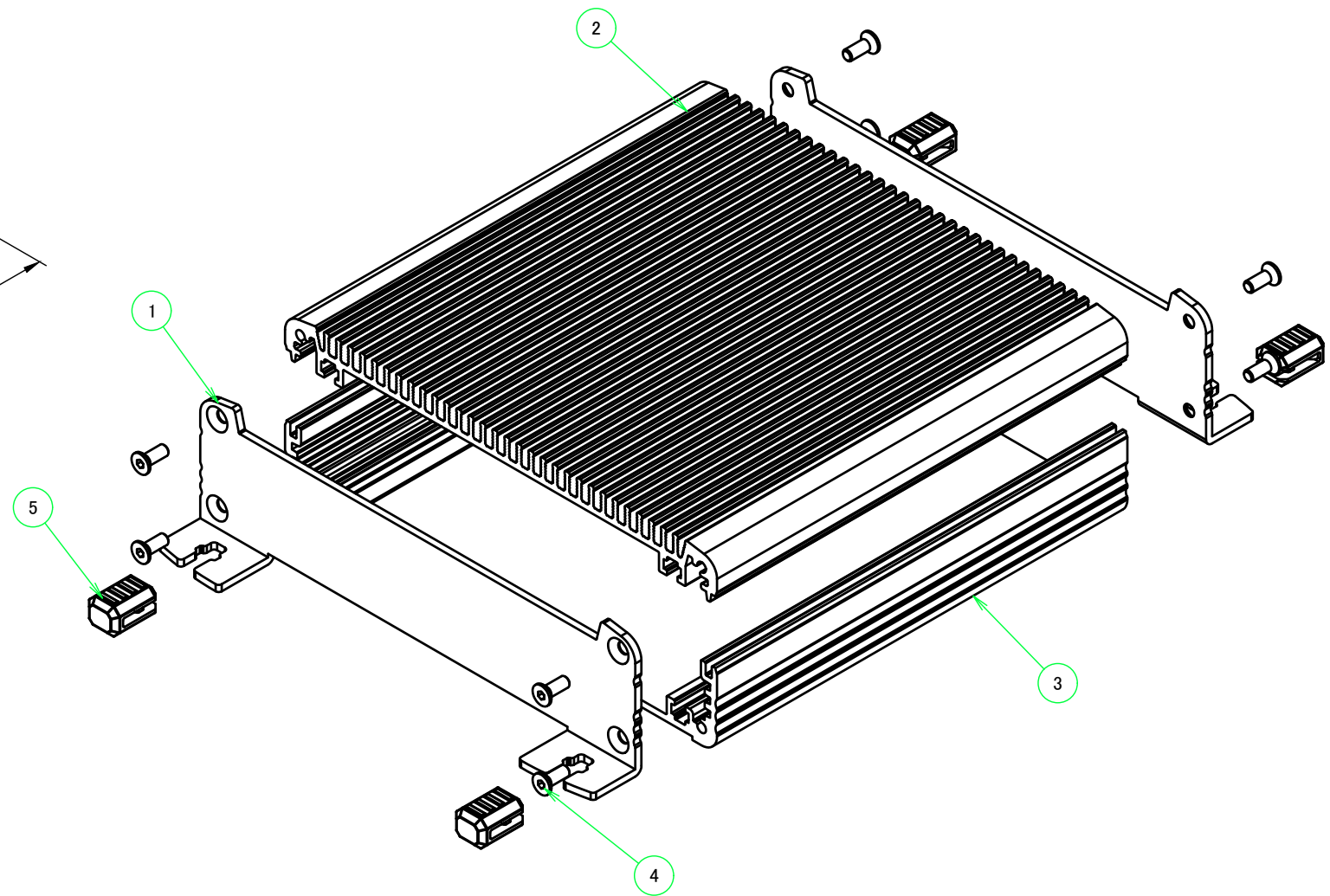

本図面および付帯する部品図の著作権は株式会社タカチ電機工業に帰属します。 / Copyright (C) TAKACHI ELECTRONICS ENCLOSURE CO., LTD. All Rights Reserved.

色仕様(型番末尾口)/Color type		
記号/Code	上下カバー/Cover	パネル/Panel
SS	シルバー/Silver	シルバー/Silver
BB	ブラック/Black	ブラック/Black

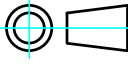
<b>TAKACHI</b> 株式会社タカチ電機工業 TAKACHI ELECTRONICS ENCLOSURE CO., LTD.		品名/Title フランジ足付ヒートシンクアルミケース FLANGED HEAT-SINK ALUMINIUM ENCLOSURE	 尺度/Scale 1 : 1.5
承認/Approved 中根	検図/Checked 野村	製図/Created 岡本	
		型番/Product number EXHF14-4-14□□	1 / 5
		作成日/Date 2022/11/30	

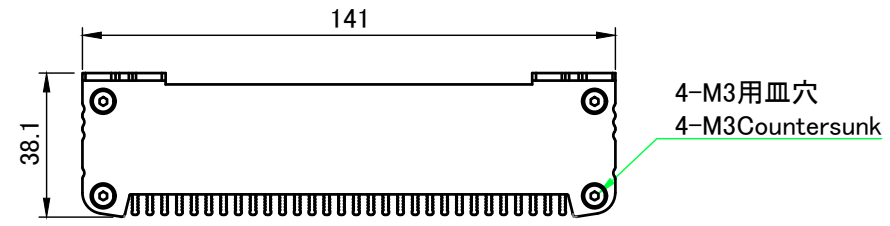

B-B (1:2)

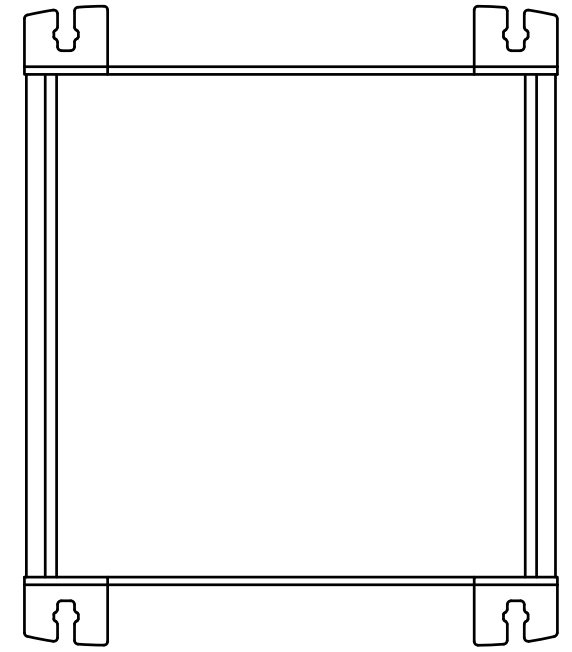
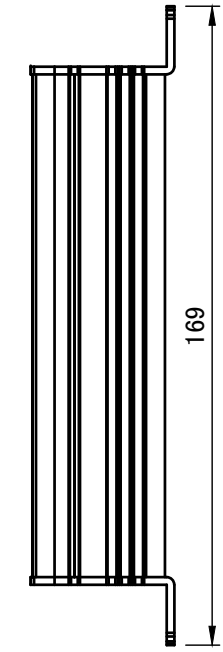
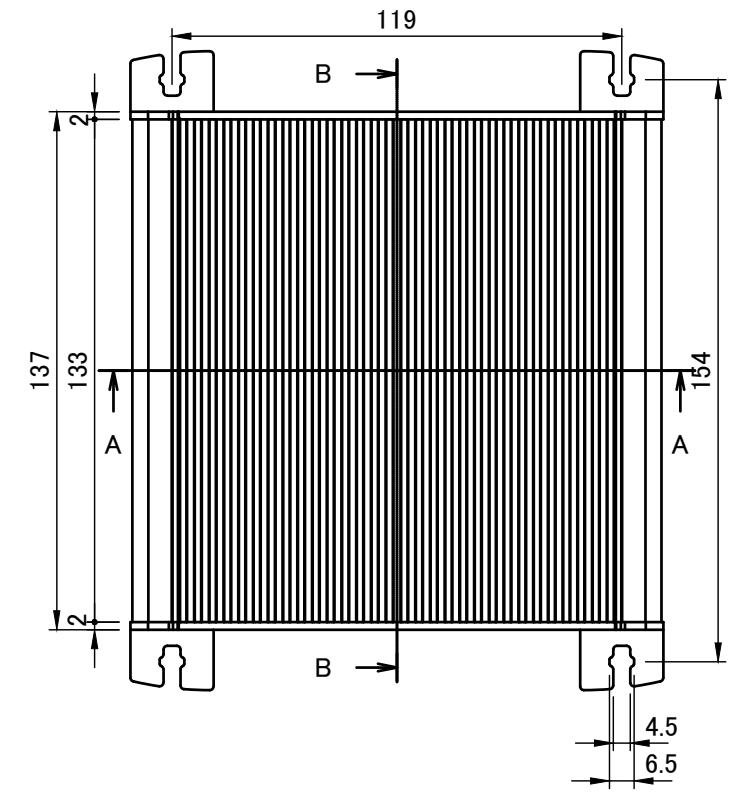
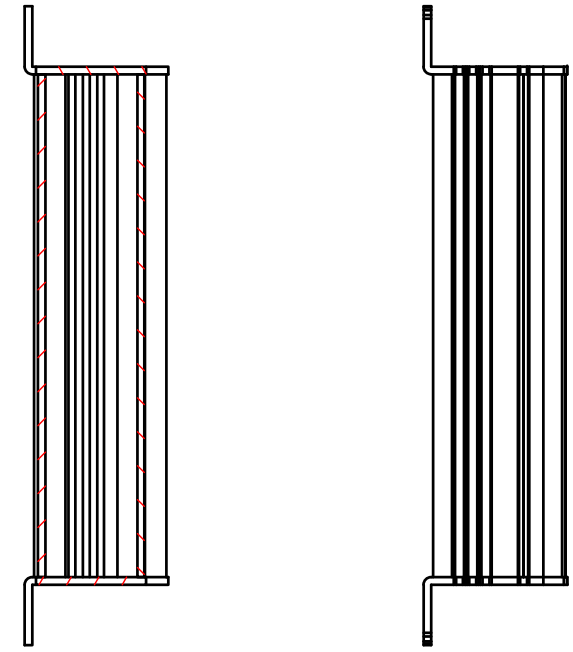

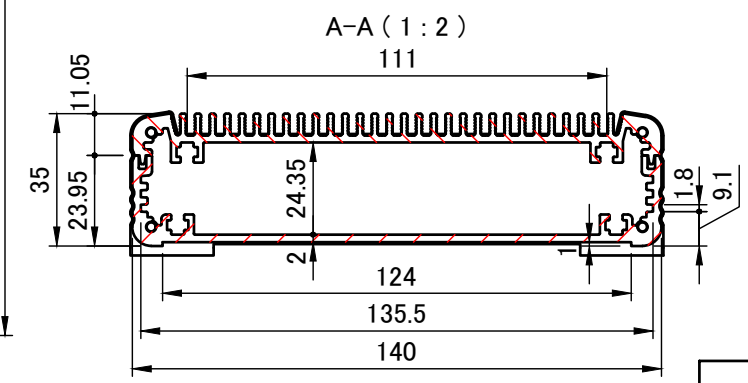
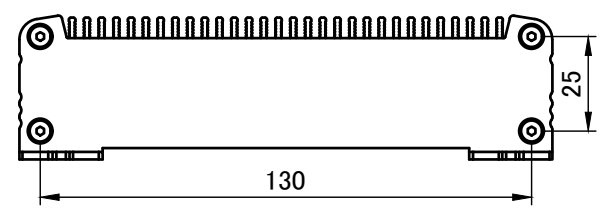
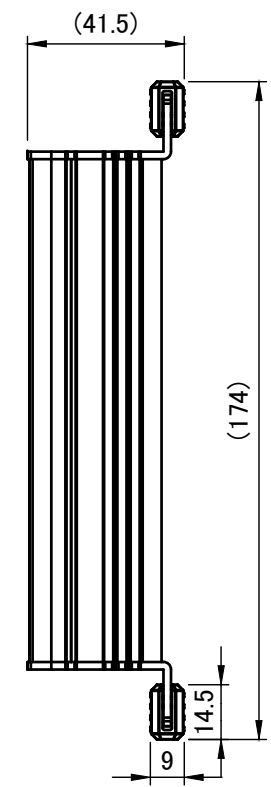
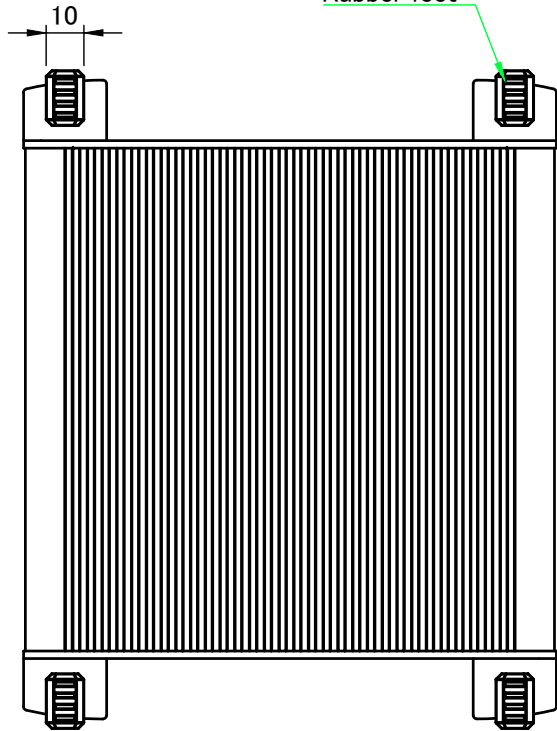

差込ゴム足  
Rubber feet

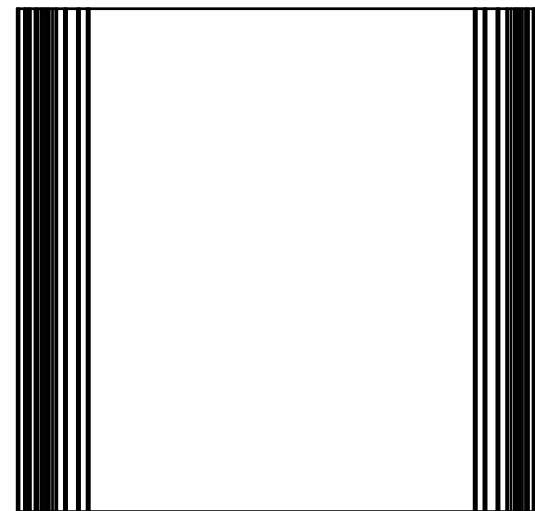
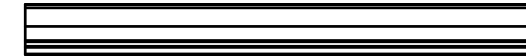
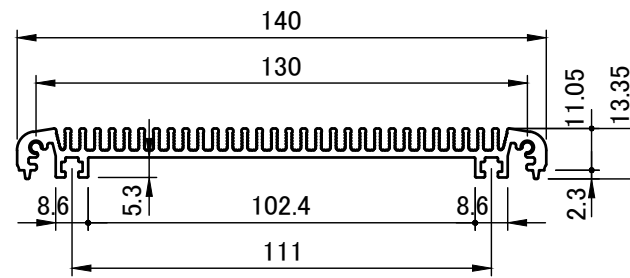
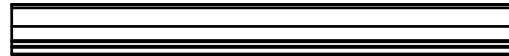
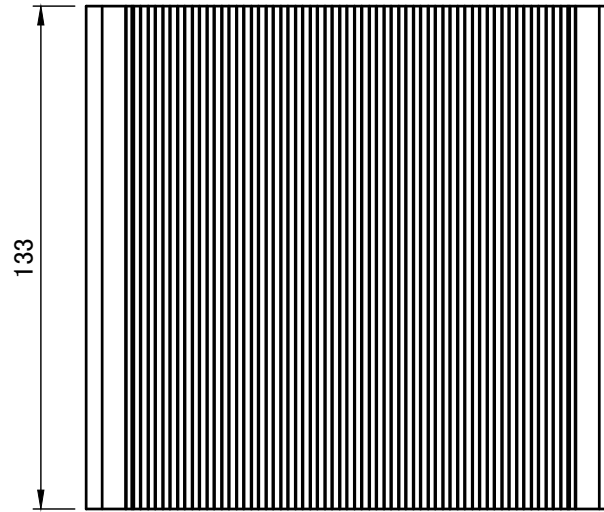

<b>株式会社タカチ電機工業</b> TAKACHI ELECTRONICS ENCLOSURE CO., LTD.			品名/Title <b>フランジ足付ヒートシンクアルミケース</b> FLANGED HEAT-SINK ALUMINIUM ENCLOSURE	尺度/Scale 1:2
承認/Approved	検図/Checked	製図/Created	型番/Product number <b>EXHF14-4-14□□</b>	
中根	野村	岡本	作成日/Date 2022/02/28	2 / 5

# ヒートシンク / Heat-sink top cover

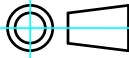

 株式会社タカチ電機工業 TAKACHI ELECTRONICS ENCLOSURE CO., LTD.		品名/Title ヒートシンクカバー HEAT-SINK TOP COVER	
承認/Approved	検図/Checked	製図/Created	
中根	野村	岡本	作成日/Date 2022/02/28
			尺度/Scale 1 : 2
			3 / 5

下カバー / Bottom frame

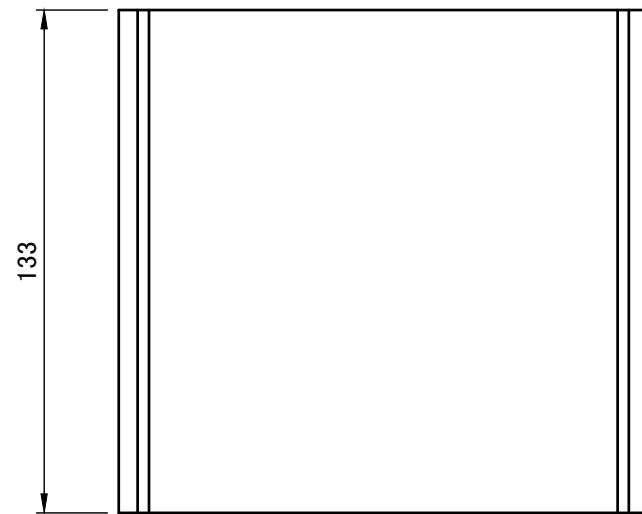
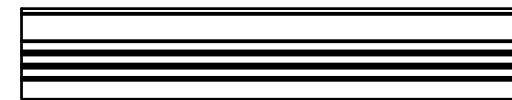
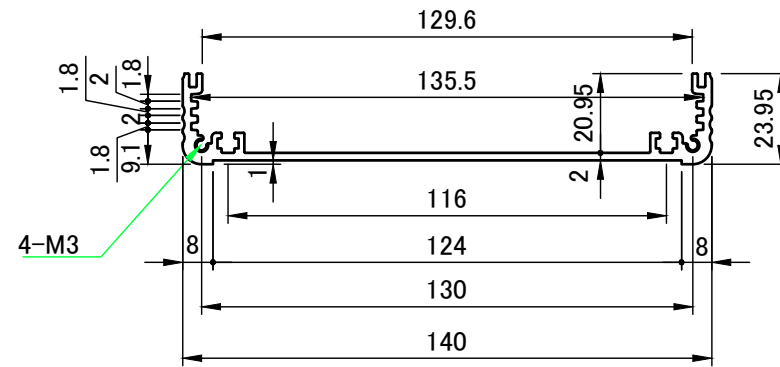
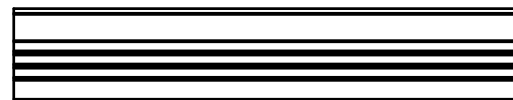
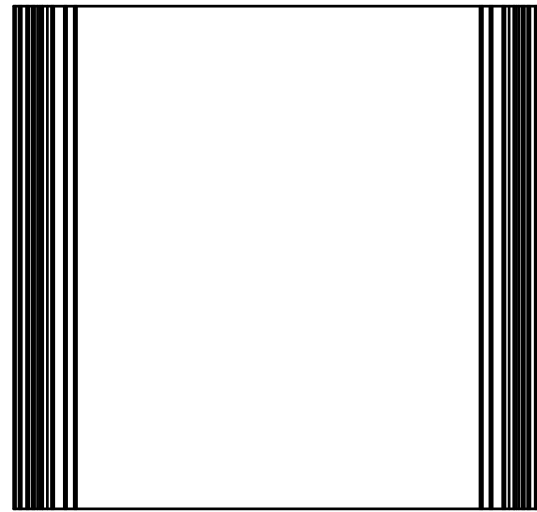

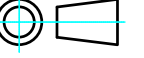
 株式会社タカチ電機工業 TAKACHI ELECTRONICS ENCLOSURE CO., LTD.			品名/Title 下カバー BOTTOM FRAME	 尺度/Scale 1 : 2
承認/Approved	検図/Checked	製図/Created	型番/Product number W140-H35-D133	
中根	野村	岡本	作成日/Date 2022/02/28	4 / 5

# フランジパネル / Flange Panel

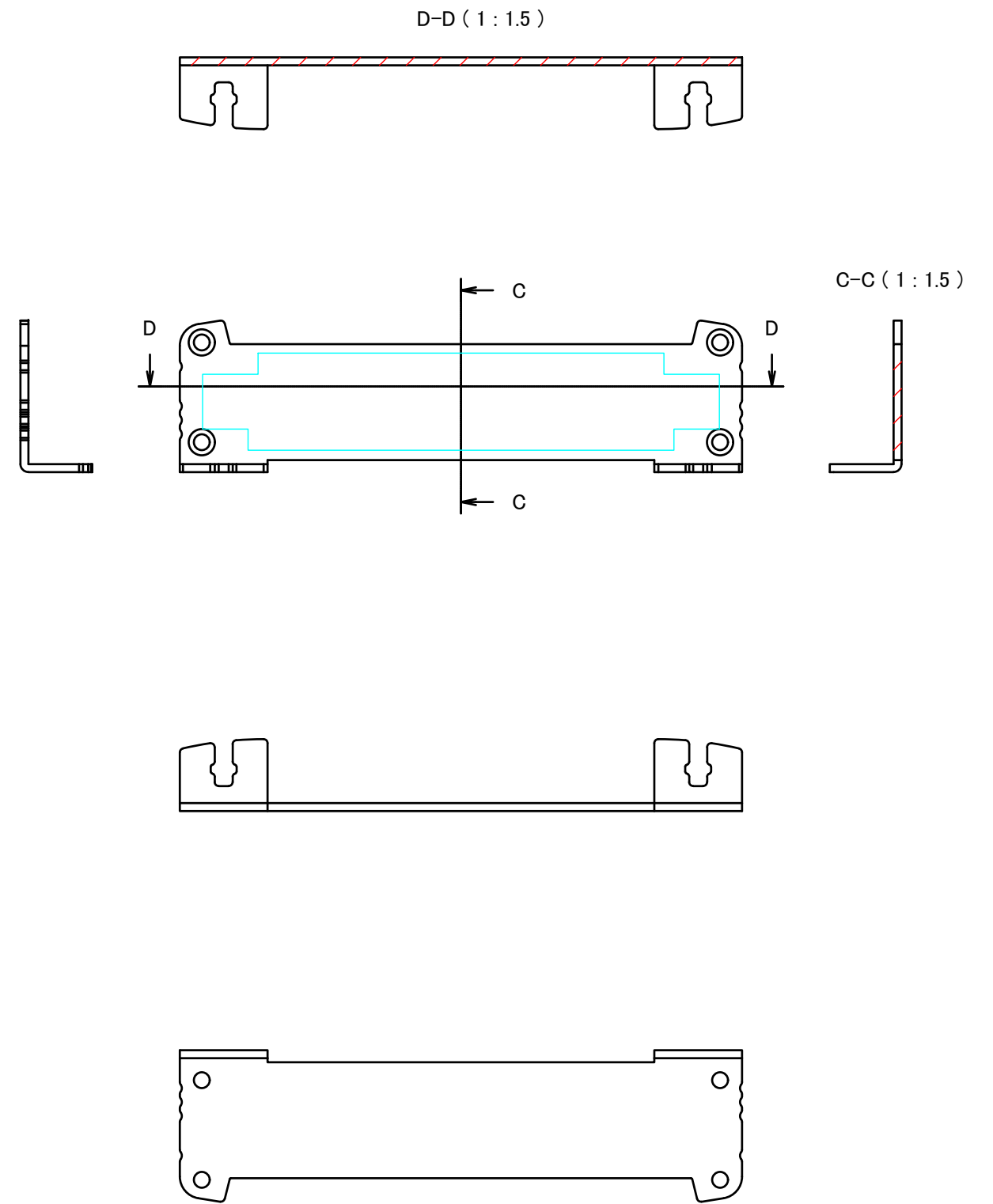
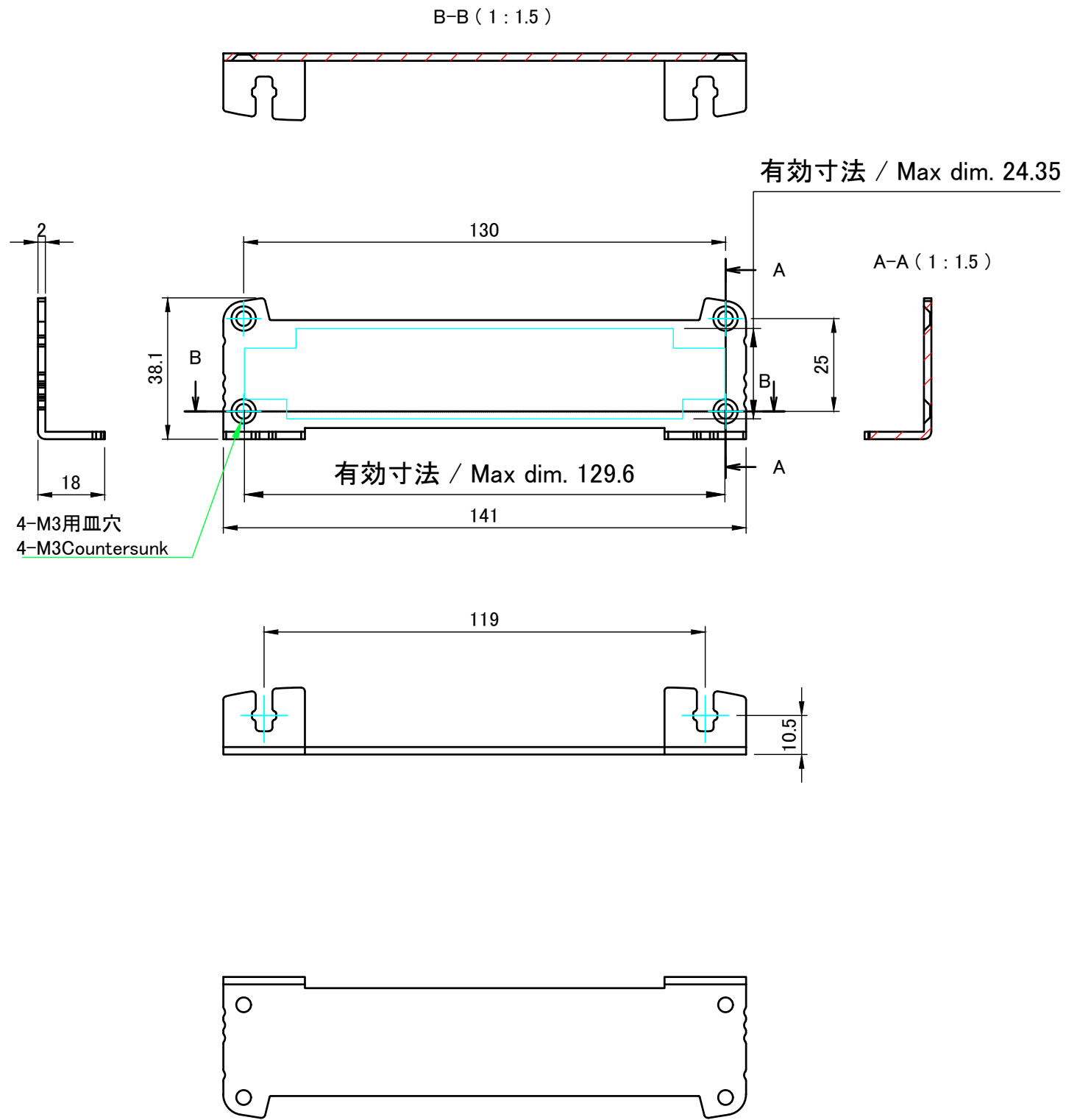

<b>株式会社タカチ電機工業</b> TAKACHI ELECTRONICS ENCLOSURE CO., LTD.			品名/Title <b>フランジパネル</b> FLANGED PANEL	尺度/Scale 1 : 1.5
承認/Approved	検図/Checked	製図/Created	型番/Product number <b>W141-H38.1</b>	
中根	野村	岡本	作成日/Date 2023/02/14	5 / 5