

ケース型番 / Product Number

EXPFS 113 - 42 -

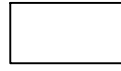

D



色記号
Color Code

寸法制限範囲 / Dimension limit range

D = 40 ~ 500

構成内容 / Components				
No.	名称 / Part name	数量 / Pcs	材質 / Material	色・表面処理 / Color・Finish
1	パネル / Panel	2	アルミ板 A1100P / Aluminium A1100	シルバー・アルマイト, ブラック・塗装 / Silver・anodized, Black・painted
2	上カバー / Top cover	1	アルミ押出材 / Extruded aluminium A6063S-T5	シルバー, ブラック・アルマイト & クリア塗装 / Silver, Black・anodized with clear coating
3	下カバー / Bottom cover	1	アルミ押出材 / Extruded aluminium A6063S-T5	シルバー, ブラック・アルマイト & クリア塗装 / Silver, Black・anodized with clear coating
4	フランジ付フレーム Flanged frame	2	PC + ABS樹脂 (UL94V-0 主成分) PC + ABS Flame-resistant	塗装無: ブラック, グレー / Black, Gray・Unpainted 塗装付: ネイビー / Navy・Painted
5	取付ビス(六角穴付M3×10) Screw (Hexagonal M3-10)	8	ステンレス Stainless steel	無処理 Unfinished

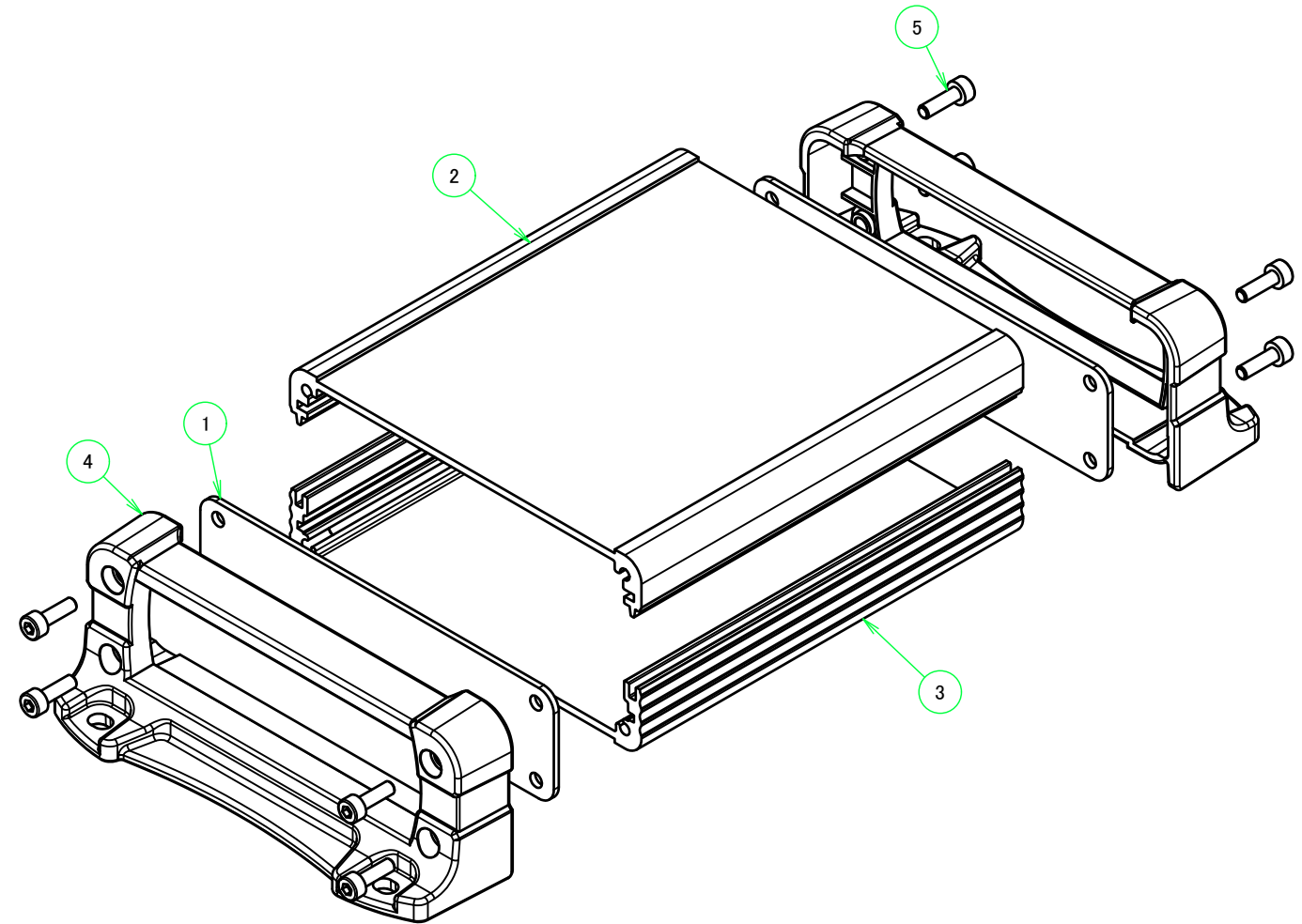
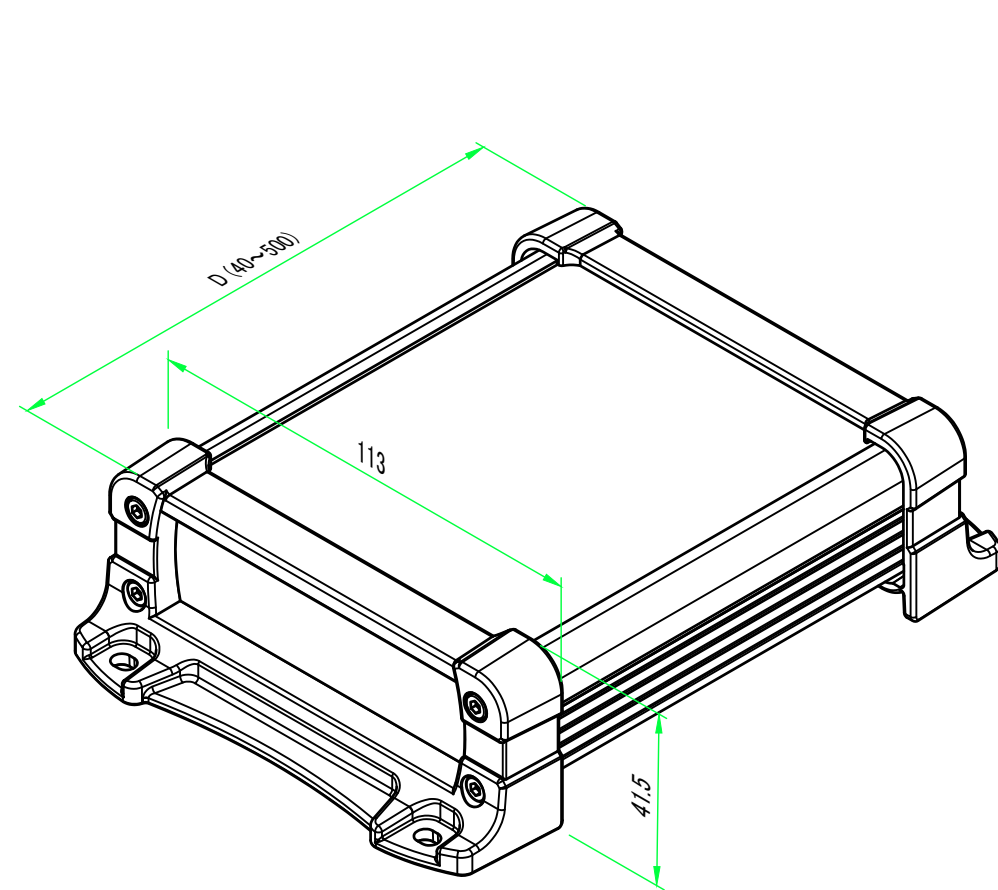

色仕様(型番末尾□□) / Color type (End of product number□□)

記号 / Code	上下カバー / Cover	フレーム / Flanged frame
SB	シルバー / Silver	ブラック / Black
SG	シルバー / Silver	グレー / Gray
SN	シルバー / Silver	ネイビー / Navy
BB	ブラック / Black	ブラック / Black
BG	ブラック / Black	グレー / Gray
BN	ブラック / Black	ネイビー / Navy

株式会社タカチ電機工業 <small>TAKACHI ELECTRONICS ENCLOSURE CO., LTD.</small>			品名/Title フランジ足付フリーサイズアルミケース アルミパネルタイプ CUSTOM SIZED FLANGED ALUMINIUM PANEL CASE	尺度/Scale 1 : 1.5
承認/Approved	検図/Checked	製図/Created	型番/Product number EXPFS113-42-□□□	
中根	大江	岡本	作成日/Date 2023/07/24	1 / 5

B-B (1:2.5)

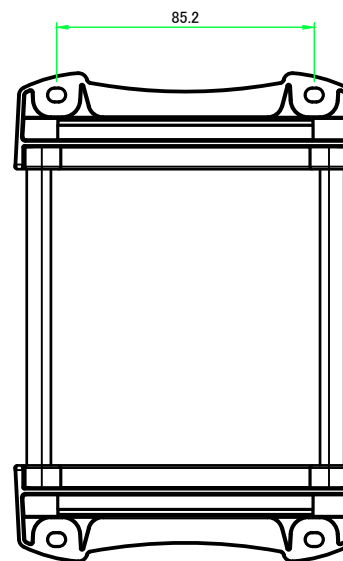
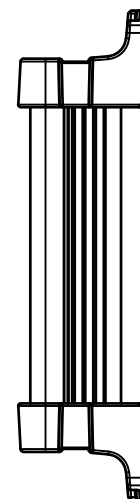
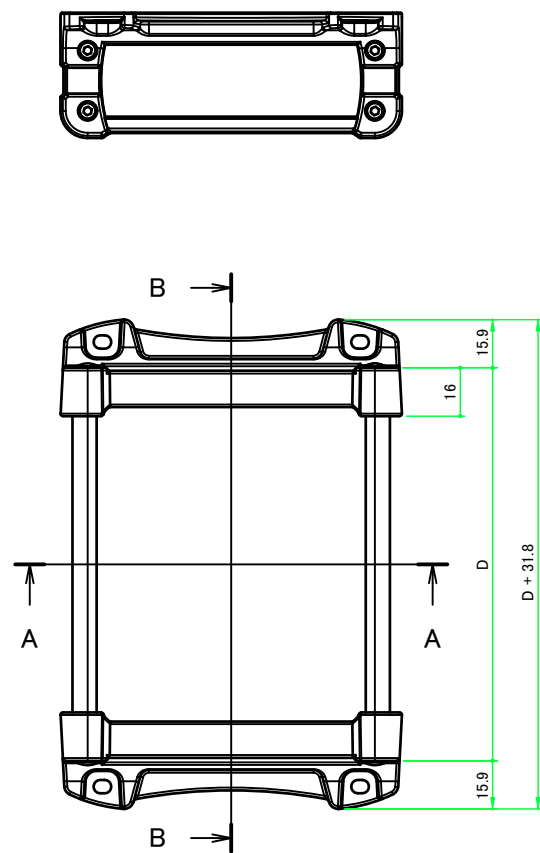
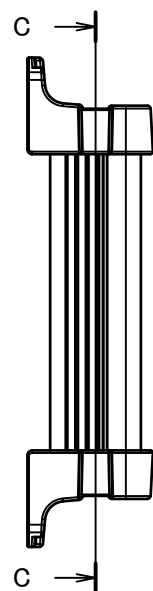
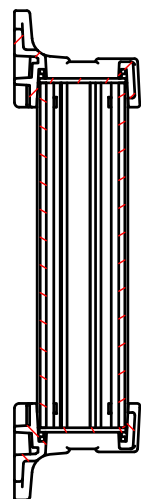

C-C (1:2.5)

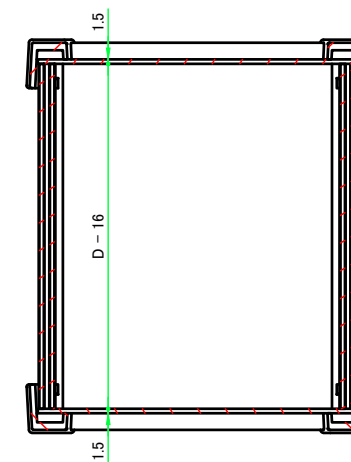

4-M3 六角穴付ボルト
4-M3 Countersunk hole

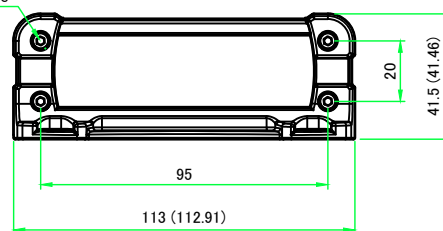

A-A (1:2.5)

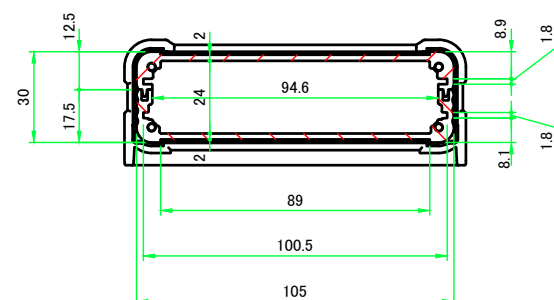

株式会社タカチ電機工業 TAKACHI ELECTRONICS ENCLOSURE CO., LTD.			品名/Title フラジ [®] 足付フリーサイズアルミケース アルミパネルタイプ CUSTOM SIZED FLANGED ALUMINIUM PANEL CASE	尺度/Scale 1:2.5
承認/Approved	検図/Checked	製図/Created	型番/Product number EXPFS113-42-□□□	
中根	大江	岡本	作成日/Date 2023/07/24	2 / 5

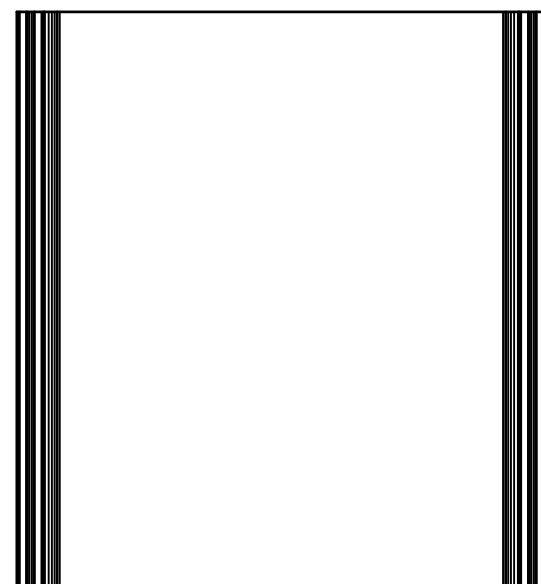
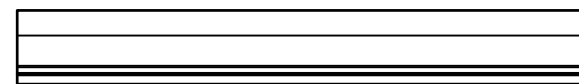
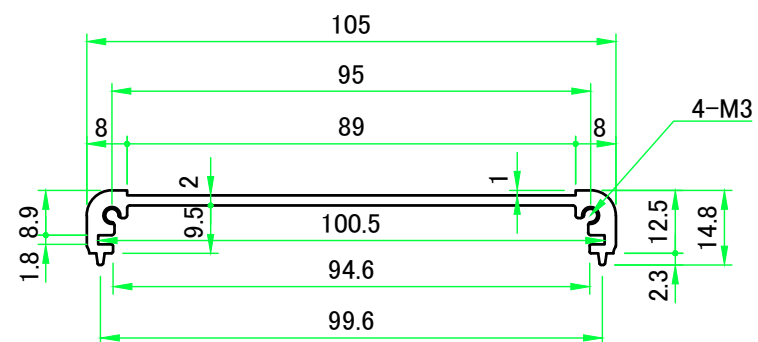
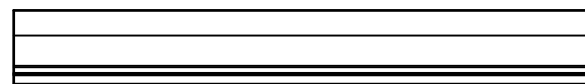
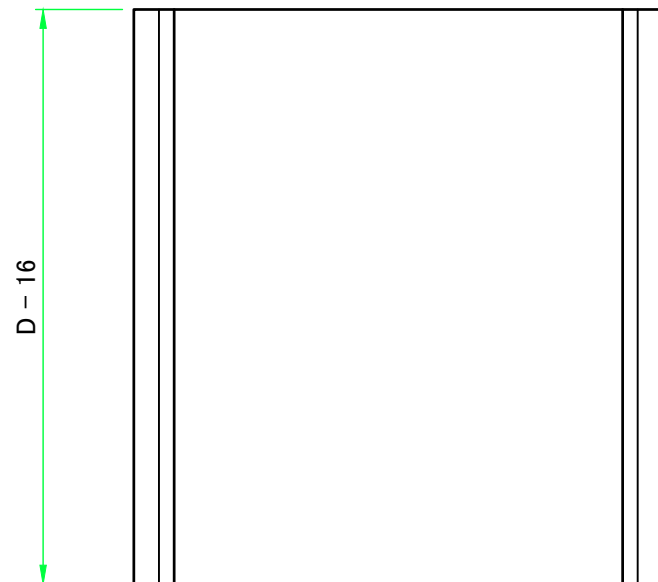

 株式会社タカチ電機工業 TAKACHI ELECTRONICS ENCLOSURE CO., LTD.			品名/Title 上カバー TOP COVER	 尺度/Scale 1 : 1.5
承認/Approved	検図/Checked	製図/Created	型番/Product number W105-D	
中根	大江	岡本	作成日/Date 2019/07/19	3 / 5

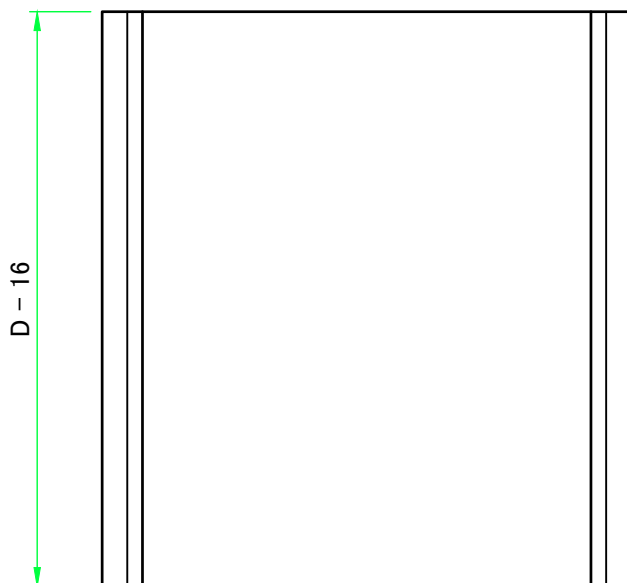
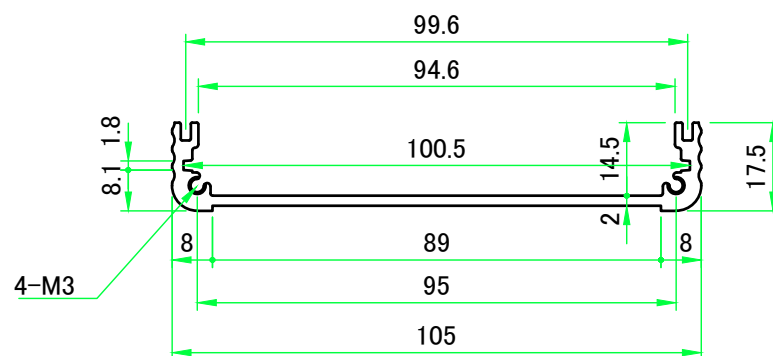
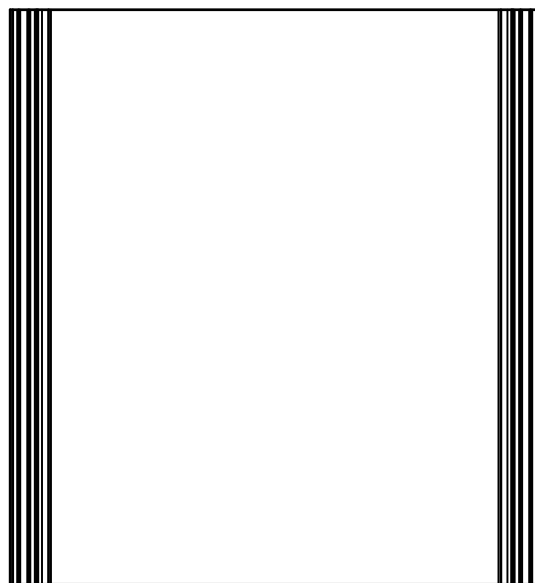

 株式会社タカチ電機工業 TAKACHI ELECTRONICS ENCLOSURE CO., LTD.			品名/Title 下カバー BOTTOM COVER	
承認/Approved	検図/Checked	製図/Created	型番/Product number W105-H30-D	
中根	大江	岡本	作成日/Date 2019/07/19	4 / 5

A-A (1:1)

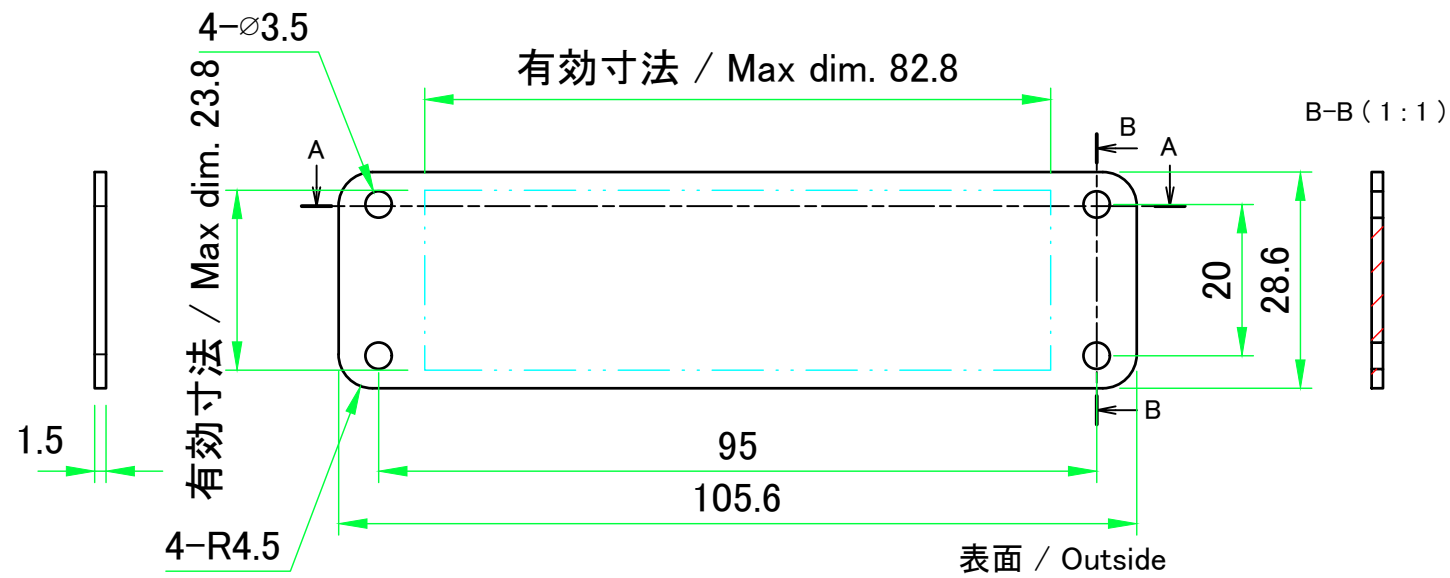
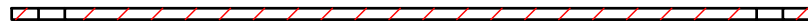

保護シート側
Surface protective film side

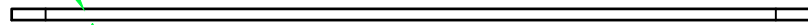

裏面 / Inside

C-C (1:1)

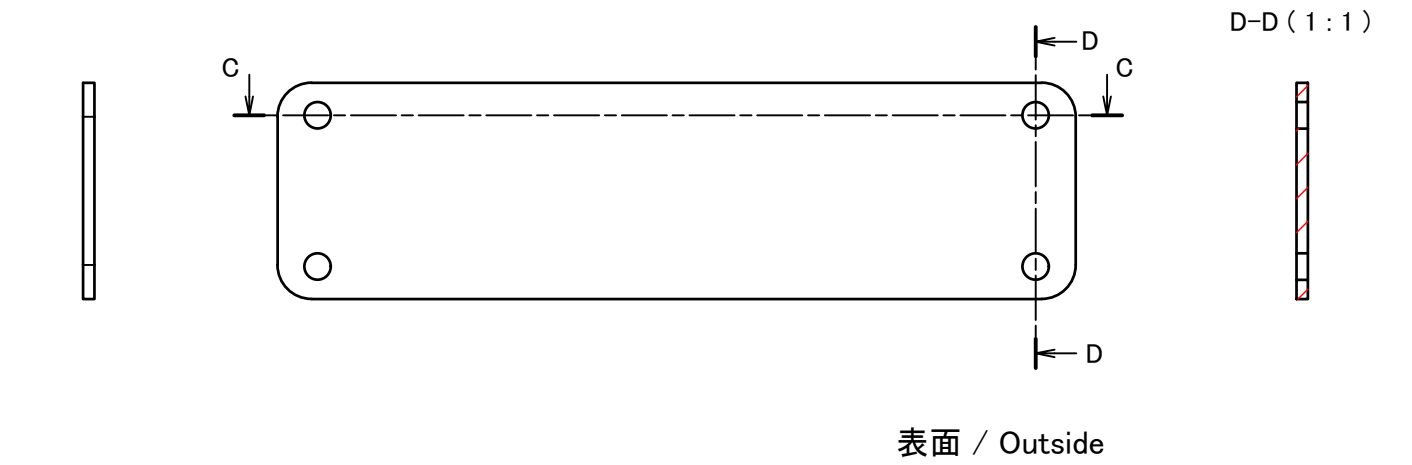

保護シート側
Surface protective film side

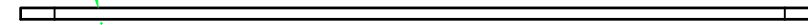

裏面 / Inside

株式会社タカチ電機工業 TAKACHI ELECTRONICS ENCLOSURE CO., LTD.			品名/Title パネル PANEL	尺度/Scale 1:1
承認/Approved 中根	検図/Checked 岡本	製図/Created 大江	型番/Product number W105 - H30	
			作成日/Date 2023/07/24	5 / 5