

構成内容 / Components				
No.	名称 / Part name	数量 / Pcs	材質 / Material	色・表面処理 / Color・Finish
1	フレーム Frame	4	アルミ押出材 A6063S-T5 Extruded aluminium A6063S-T5	シルバー、ブラック・アルマイト & クリア塗装 Silver, black・Anodized & clear coated
2	コーナーブロック Corner block	4	ABS樹脂 UL94HB ABS UL94HB	ライトグレー、ブラック Light gray, Black
3	コーナーキャップ / Blind plug	8	エラストマ / TPE	ライトグレー、ブラック / Light gray, Black
4	ハメ込みパネル / Slide panel	1	アルミ板 / Aluminium A1100P t=1.5 アルミ板 / Aluminium A1100P t=1.5	シルバーアルマイト / Silver・Anodized ブラック・塗装 / Black・Painted
5	ねじ止めパネル / Screwed panel	1	アルミ板 / Aluminium A1100P t=1.5 アルミ板 / Aluminium A1100P t=1.5	シルバーアルマイト / Silver・Anodized ブラック・塗装 / Black・Painted
6	取付ビス(M4 x 15 ナベ) Screw(M4 - 15 Pan head)	16	鉄 Steel	三価クロメート Trivalent chromate
7	パネル取付ビス(十字穴台形ビスM3 x 5) Screw(Original trapezoid head M3 - 5)	4	鉄 Steel	ニッケルメッキ、三価黒クロメート Nickel plated, Black trivalent chromate

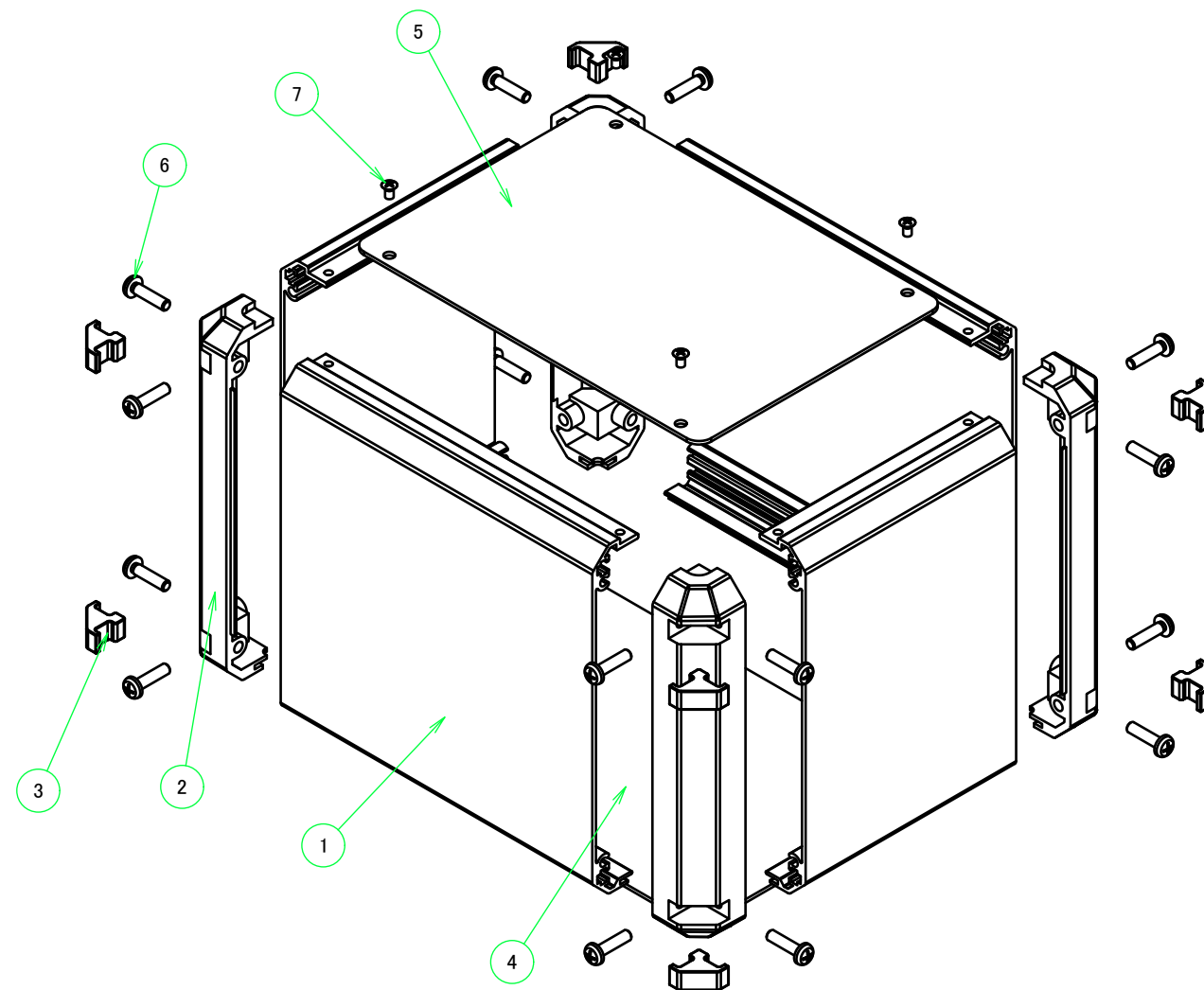

色仕様(型番末尾□) / Color Type(End of product number□)			
記号 / Code	パネル / Panel	フレーム / Freme	コーナー / Corner
G S	シルバー / Silver	シルバー / Silver	ライトグレー / Light gray
B S	シルバー / Silver	シルバー / Silver	ブラック / Black
B X	シルバー / Silver	ブラック / Black	ブラック / Black
B B	ブラック / Black	ブラック / Black	ブラック / Black

株式会社タカチ電機工業 TAKACHI ELECTRONICS ENCLOSURE CO., LTD.			品名/Title コントロールボックス ALUMINIUM CONTROL BOX	尺度/Scale 1:2.5
承認/Approved	検図/Checked	製図/Created	型番/Product number FC15-20-15□	
中根	大江	常山	作成日/Date 2022/11/04	1 / 7

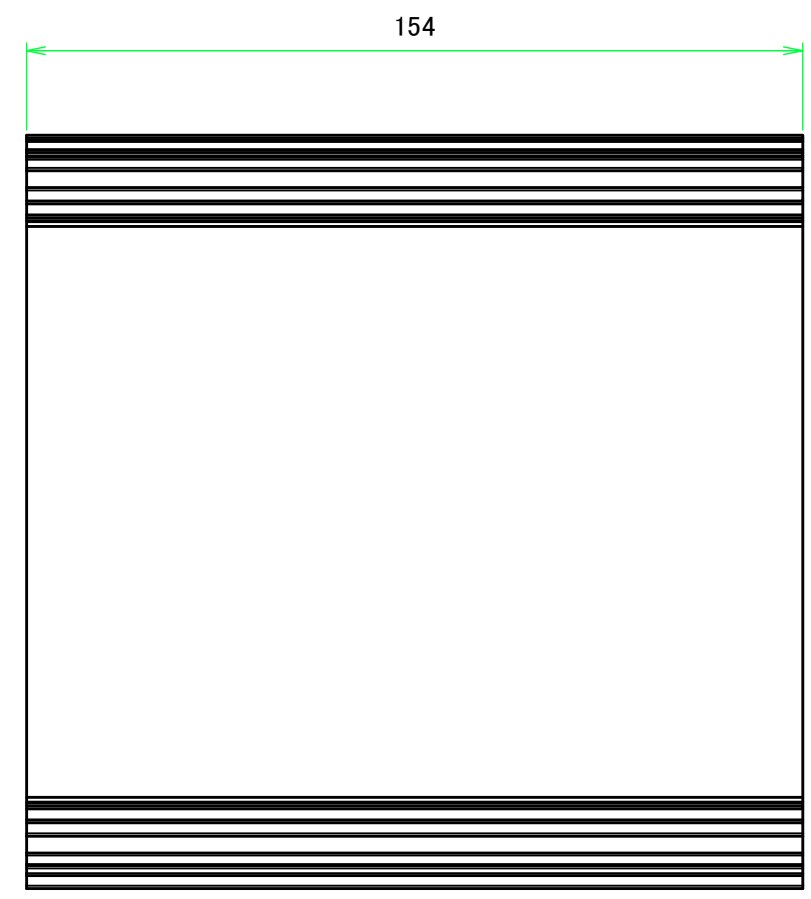
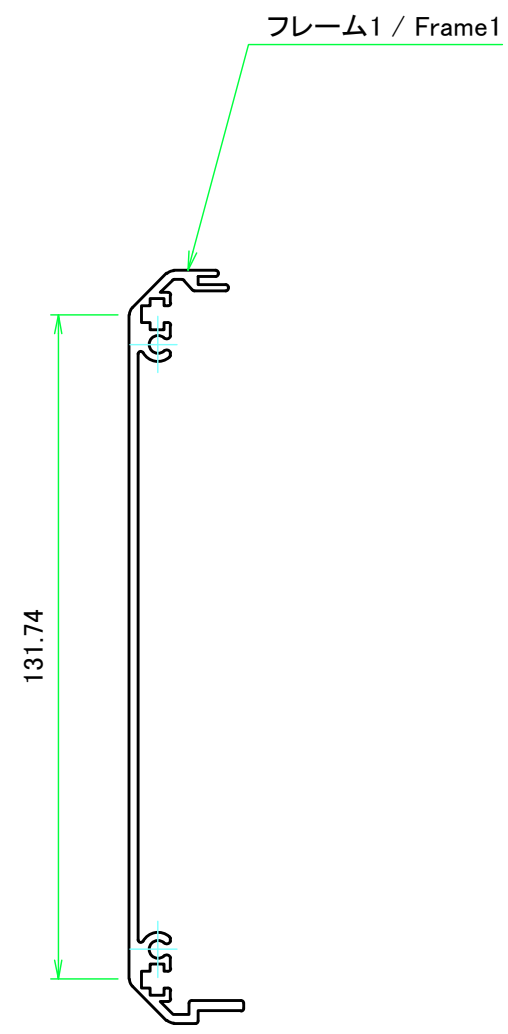
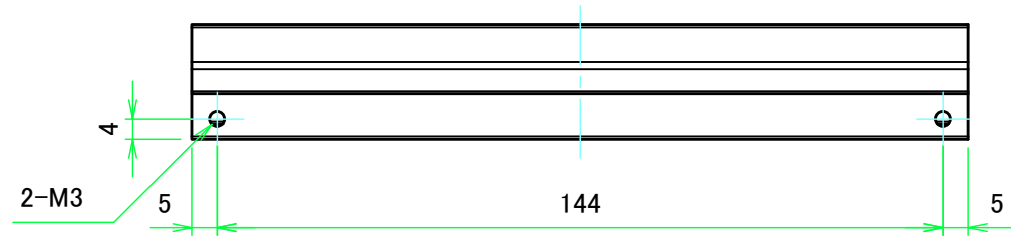
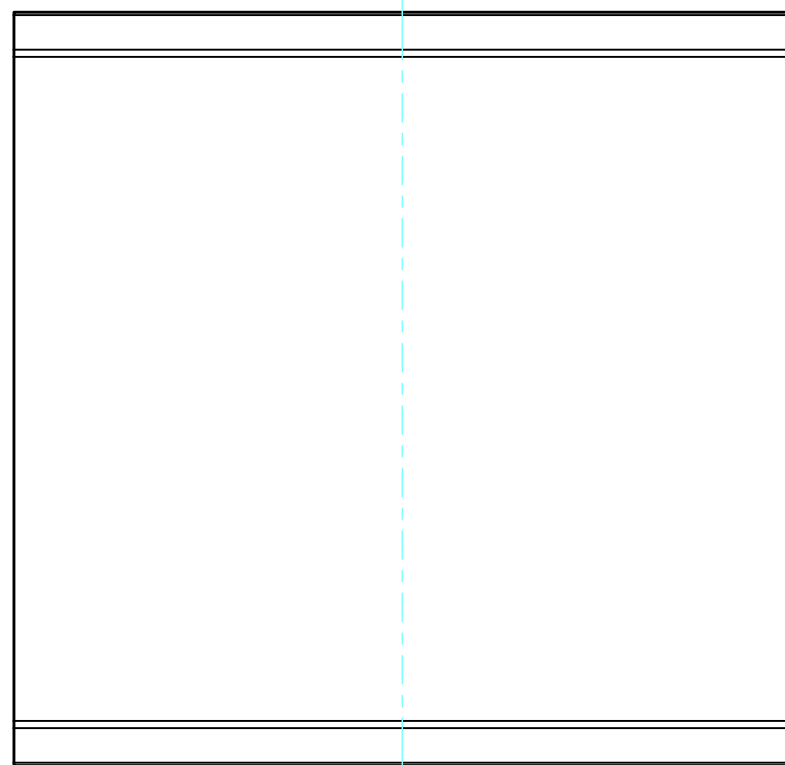
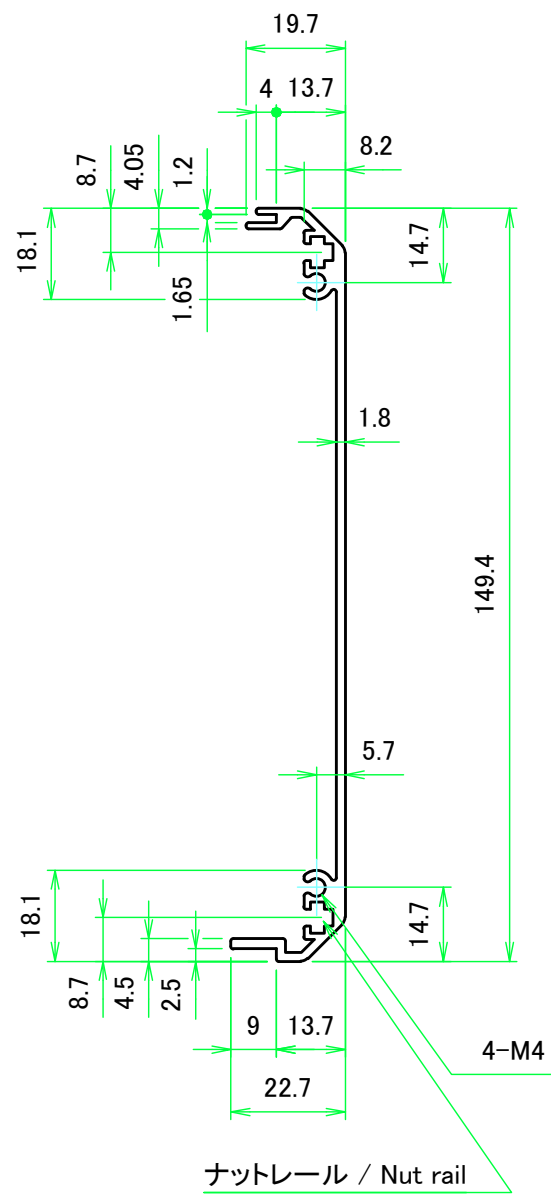
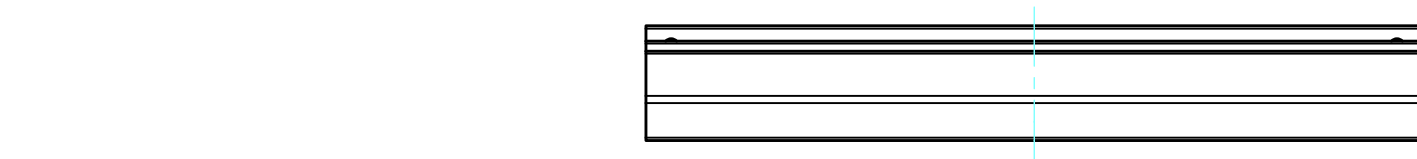

株式会社タカチ電機工業 TAKACHI ELECTRONICS ENCLOSURE CO., LTD.		品名/Title フレーム1 Frame1	
承認/Approved	検図/Checked	製図/Created	
	大江	常山	作成日/Date 2017/08/31
			尺度/Scale 1:1.5
			3 / 7

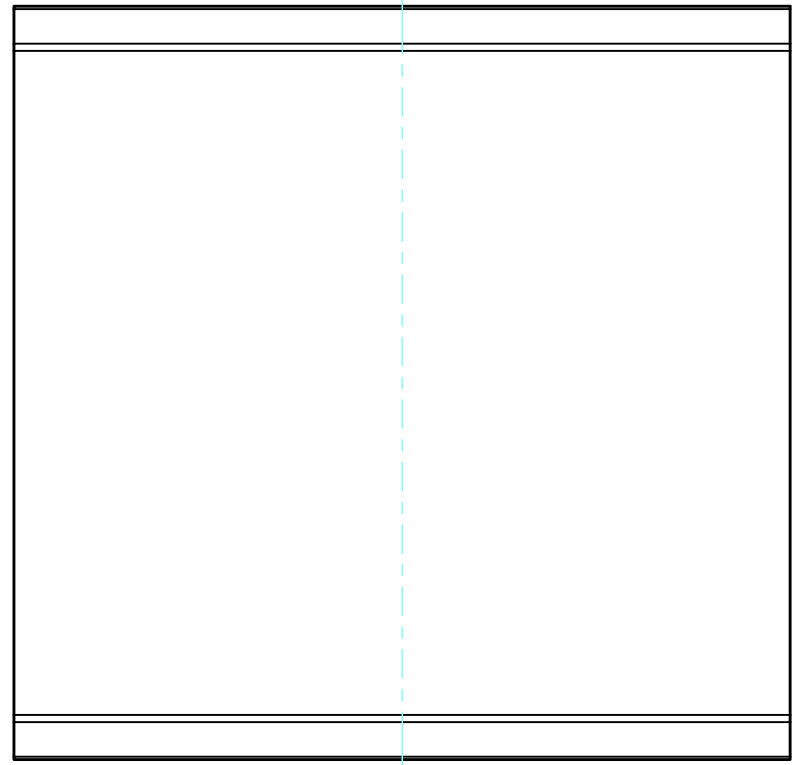

フレーム2 / Frame2

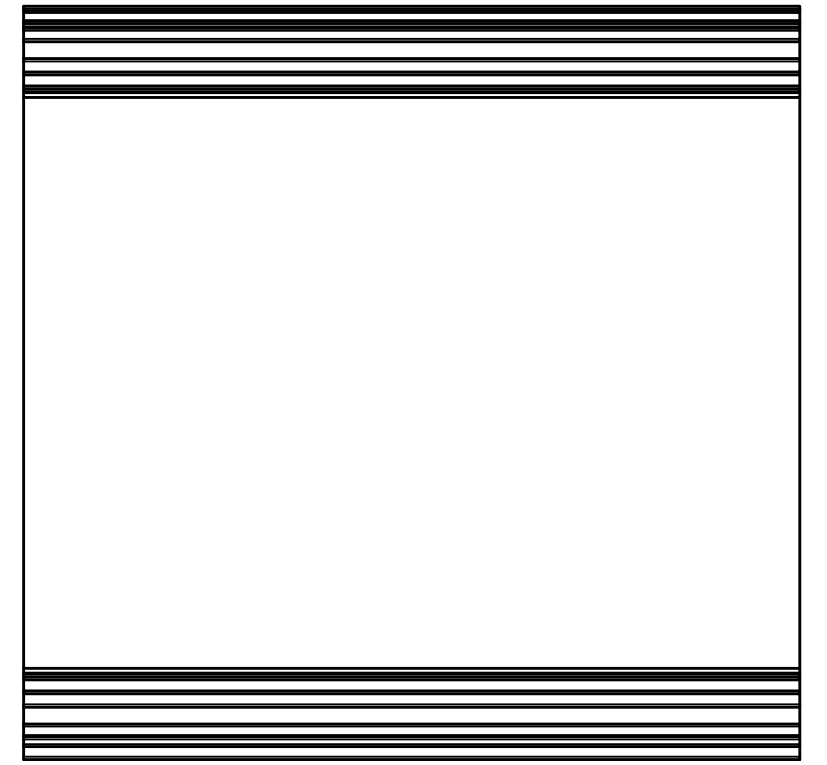
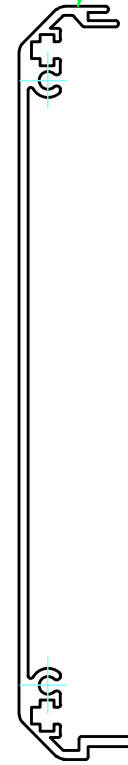

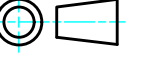
 株式会社タカチ電機工業 TAKACHI ELECTRONICS ENCLOSURE CO., LTD.		品名/Title フレーム2 Frame2	
承認/Approved	検図/Checked	製図/Created	
	大江	常山	型番/Product number H150.4 - W200
			作成日/Date 2017/08/31
			4 / 7

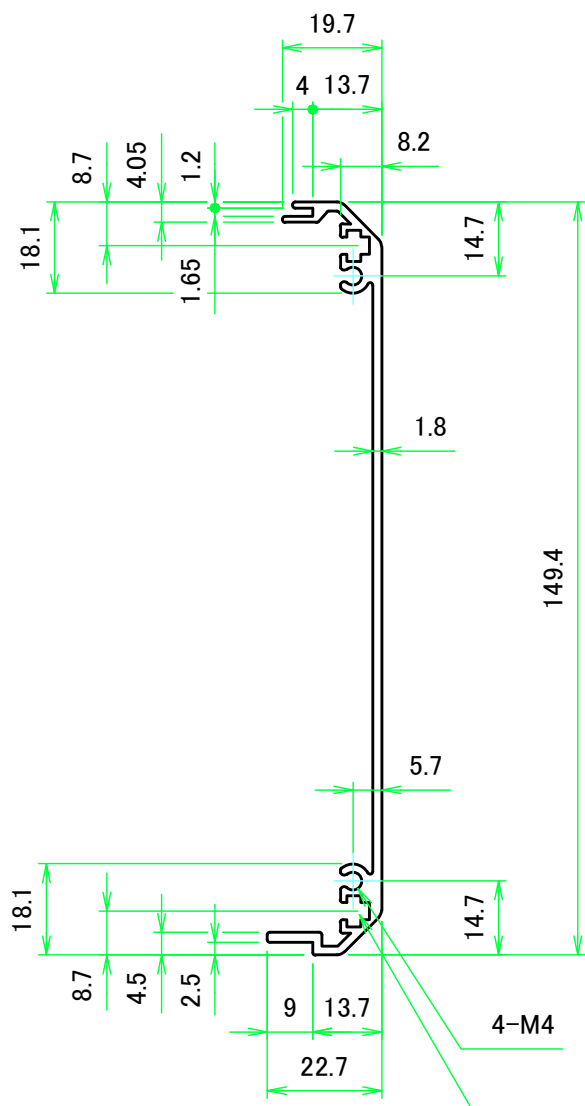

ナットレール / Nut rail

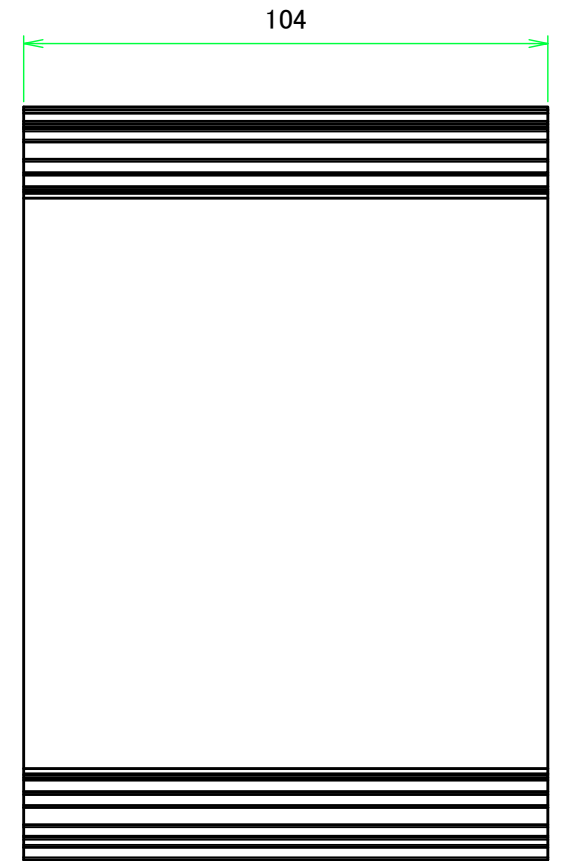
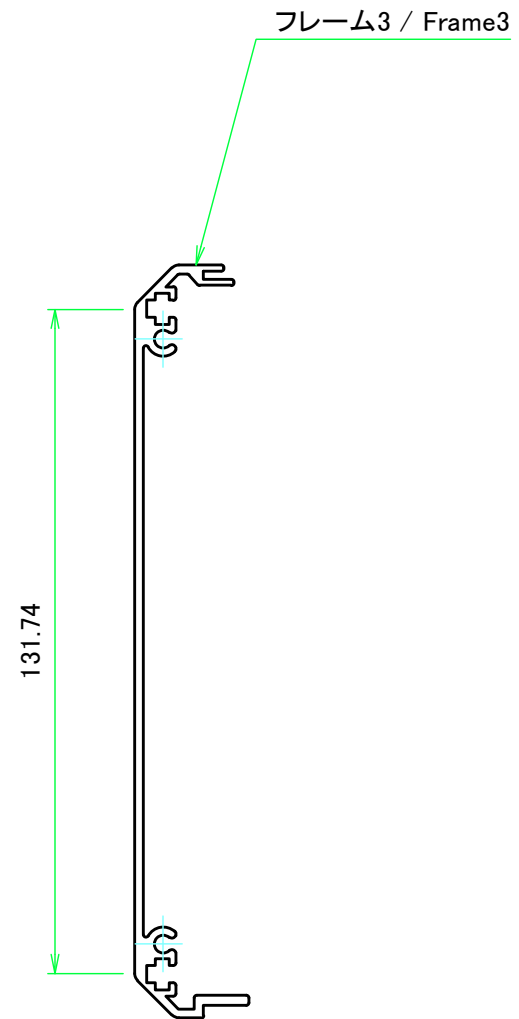
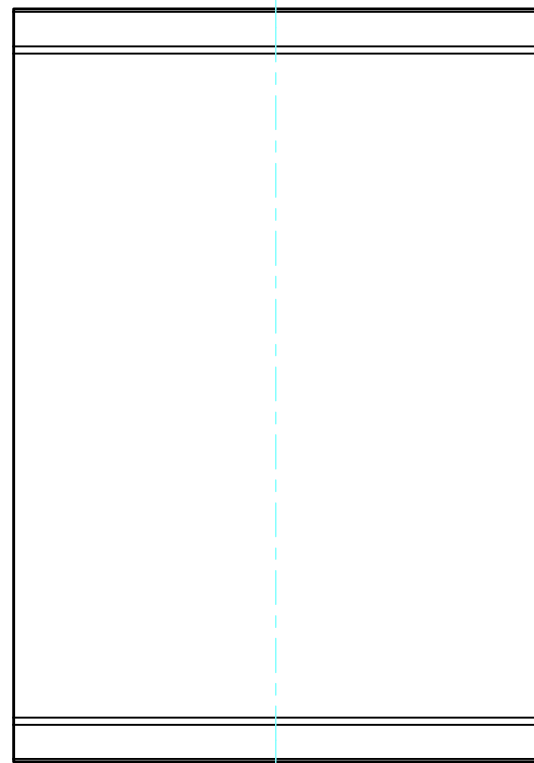
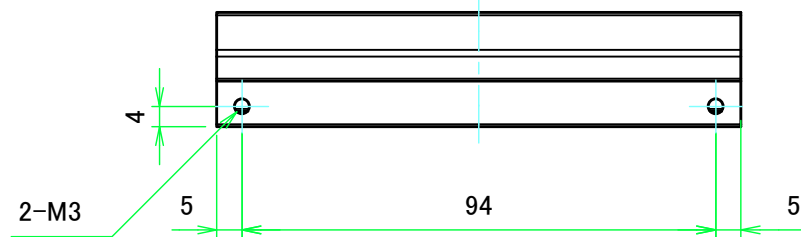

株式会社タカチ電機工業 TAKACHI ELECTRONICS ENCLOSURE CO., LTD.			品名/Title フレーム3 Frame3	尺度/Scale 1:1.5
承認/Approved	検図/Checked	製図/Created	型番/Product number H150.4 - D150	
	大江	常山	作成日/Date 2017/08/31	5 / 7

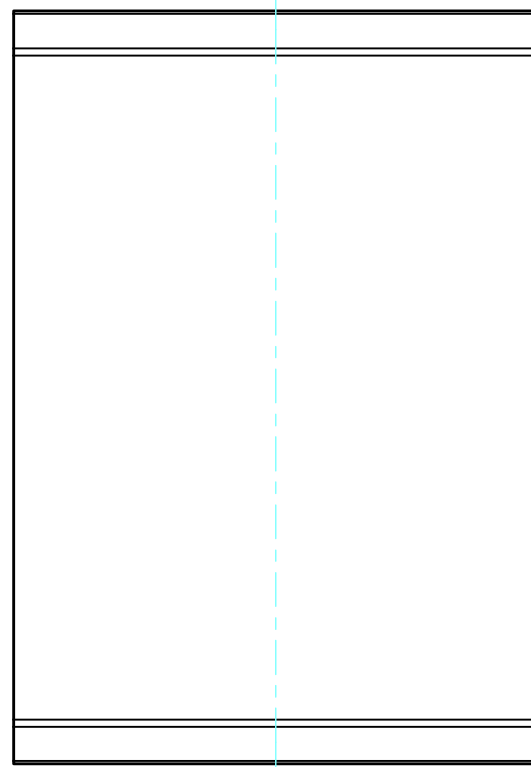
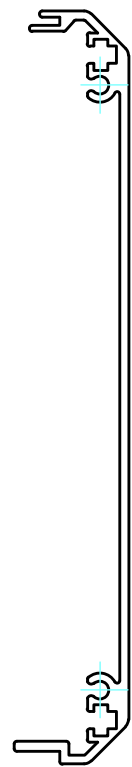

フレーム4 / Frame4

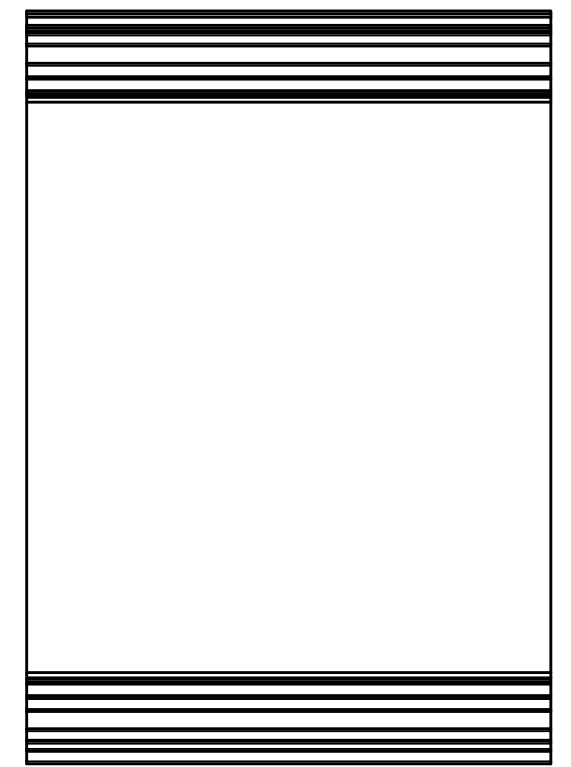
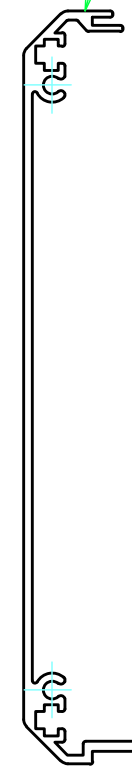

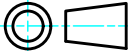
 株式会社タカチ電機工業 TAKACHI ELECTRONICS ENCLOSURE CO., LTD.		品名/Title フレーム4 Frame4	
承認/Approved	検図/Checked	製図/Created	
	大江	常山	作成日/Date 2017/08/31
			尺度/Scale 1:1.5 6 / 7

ハメ込みパネル / Slide panel

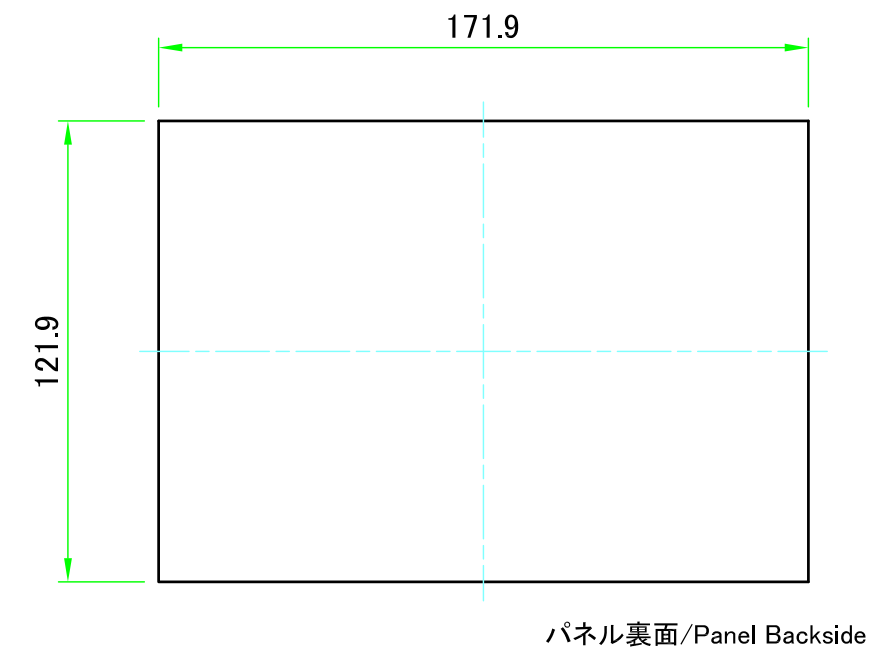
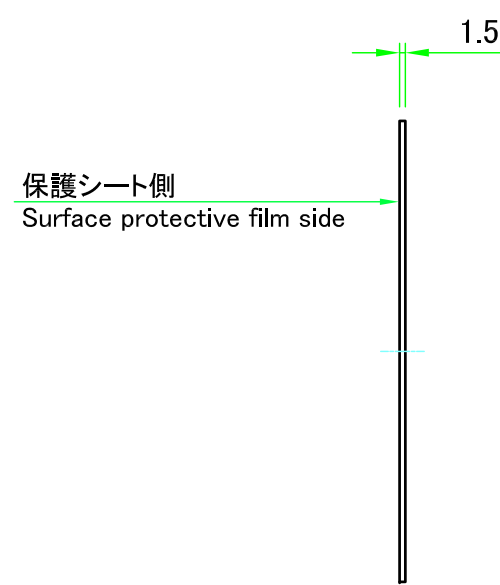
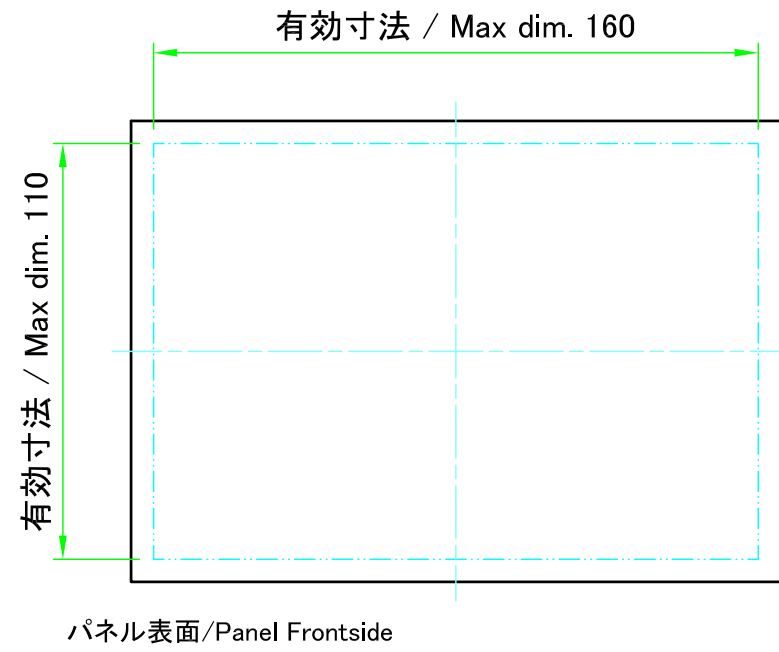

ねじ止めパネル / Screwed panel

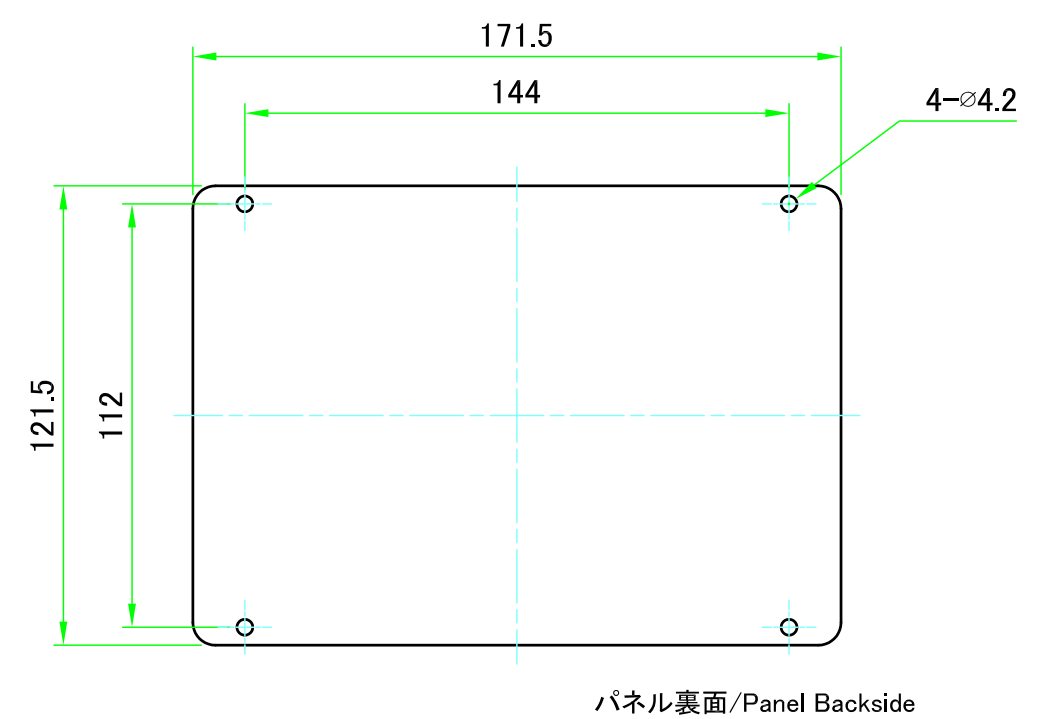
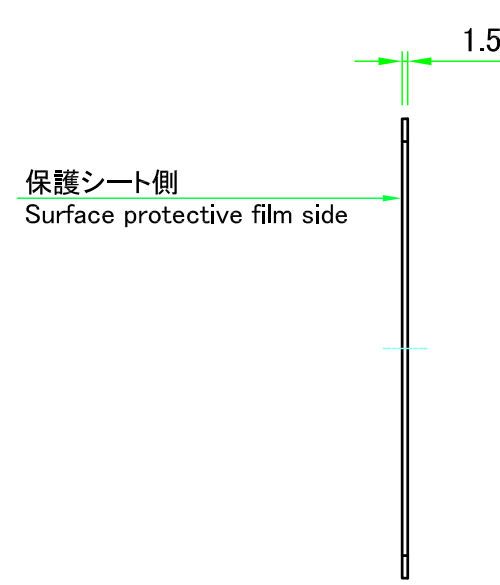
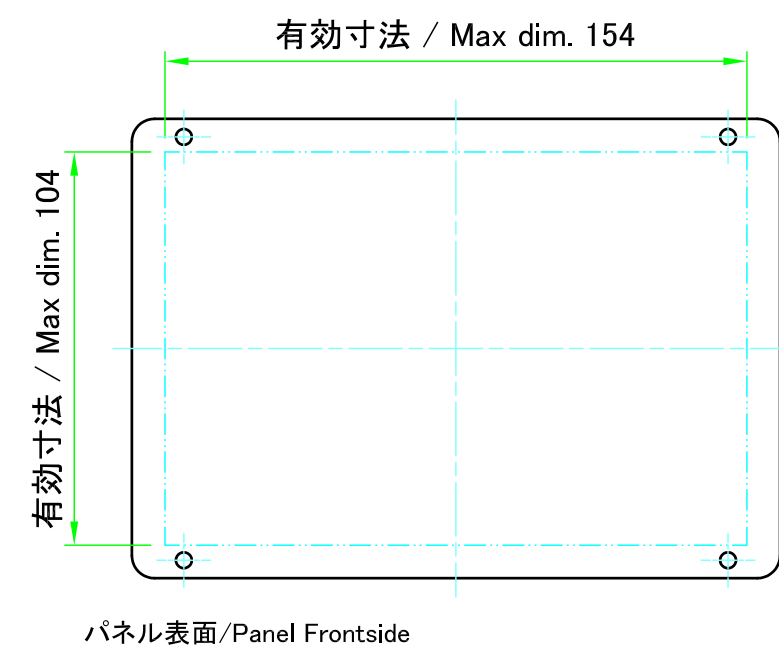

株式会社タカチ電機工業 TAKACHI ELECTRONICS ENCLOSURE CO., LTD.			品名/Title パネル Panel	尺度/Scale 1:2
承認/Approved	検図/Checked	製図/Created	型番/Product number W200 - D150	
中根	大江	常山	作成日/Date 2020/07/27	7 / 7