

構成内容 / Components				
No.	名称 / Part name	数量 / Pcs	材質 / Material	色・表面処理 / Color・Finish
1	フレーム Frame	4	アルミ押出材 A6063S-T5 Extruded aluminium A6063S-T5	シルバー, ブラック・アルマイト & クリア塗装 Silver, black・Anodized & clear coated
2	コーナーブロック Corner block	4	ABS樹脂 UL94HB ABS UL94HB	ライトグレー, ブラック Light gray, Black
3	コーナーキャップ / Blind plug	8	エラストマ / TPE	ライトグレー, ブラック / Light gray, Black
4	ハメ込みパネル / Slide panel	1	アルミ板 / Aluminium A1100P t=1.5 アルミ板 / Aluminium A1100P t=1.5	シルバーアルマイト / Silver・Anodized ブラック・塗装 / Black・Painted
5	ねじ止めパネル / Screwed panel	1	アルミ板 / Aluminium A1100P t=1.5 アルミ板 / Aluminium A1100P t=1.5	シルバーアルマイト / Silver・Anodized ブラック・塗装 / Black・Painted
6	取付ビス(M3 x 15 ナベ) Screw(M3 - 15 Pan head)	16	鉄 Steel	三価クロメート Trivalent chromate
7	パネル取付ビス(十字穴台形ビスM3 x 5) Screw(Original trapezoid head M3 - 5)	4	鉄 Steel	ニッケルメッキ, 三価黒クロメート Nickel plated, Black trivalent chromate

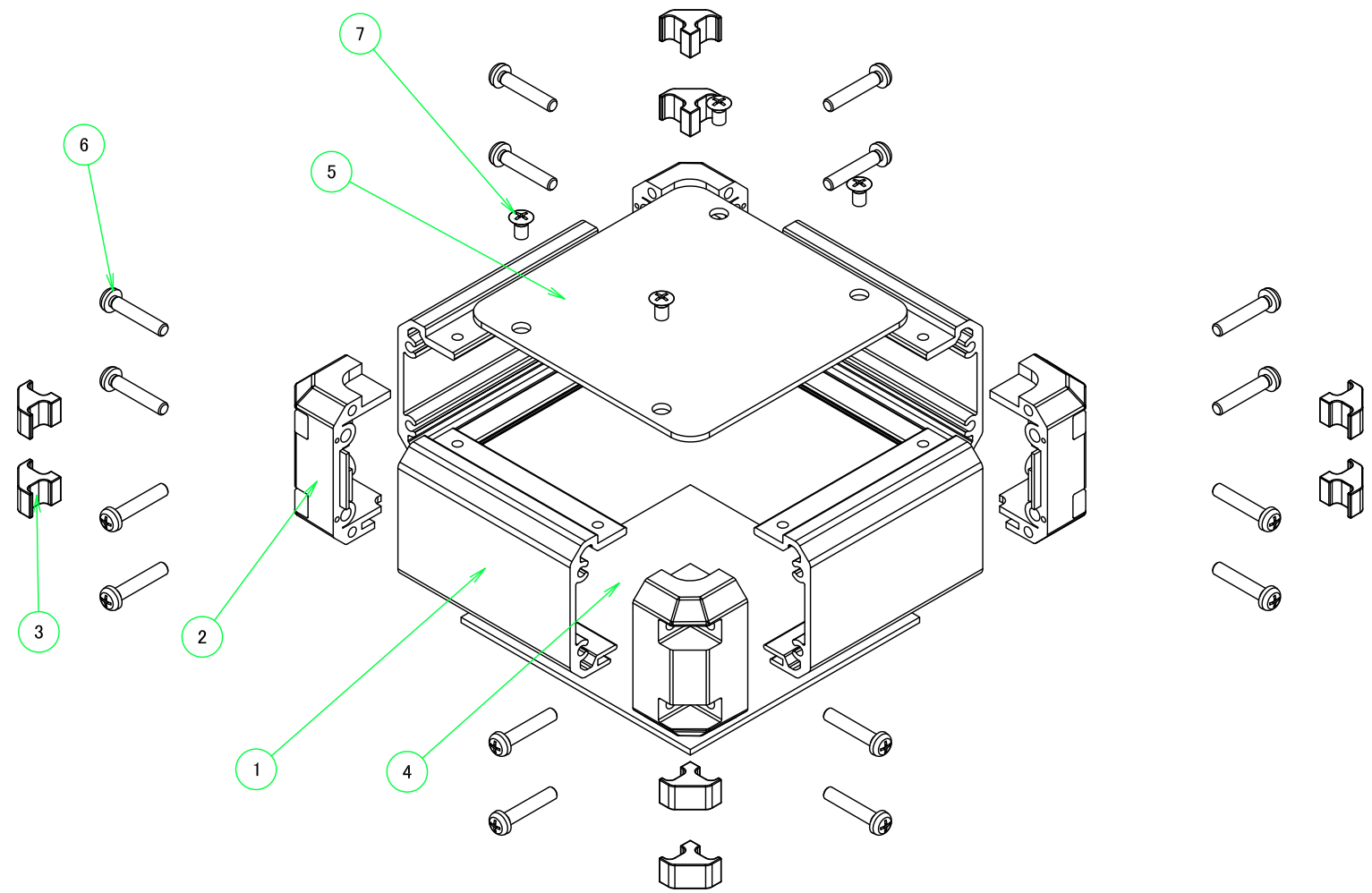

色仕様(型番末尾□) / Color Type (End of product number□)			
記号 / Code	パネル / Panel	フレーム / Freme	コーナー / Corner
G S	シルバー / Silver	シルバー / Silver	ライトグレー / Light gray
B S	シルバー / Silver	シルバー / Silver	ブラック / Black
B X	シルバー / Silver	ブラック / Black	ブラック / Black
B B	ブラック / Black	ブラック / Black	ブラック / Black

株式会社タカチ電機工業 TAKACHI ELECTRONICS ENCLOSURE CO., LTD.			品名/Title コントロールボックス ALUMINIUM CONTROL BOX	尺度/Scale 1:1.5
承認/Approved	検図/Checked	製図/Created	型番/Product number FC4-9-9□	
中根	大江	常山	作成日/Date 2022/11/01	1 / 7

外視図，内視図 / External View, Internal View

フレーム1側 / Frame1 side

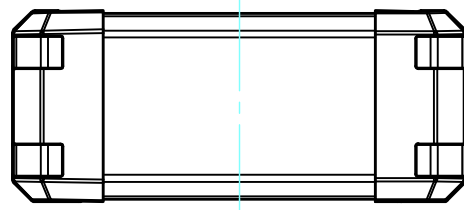

フレーム3側 / Frame3 side

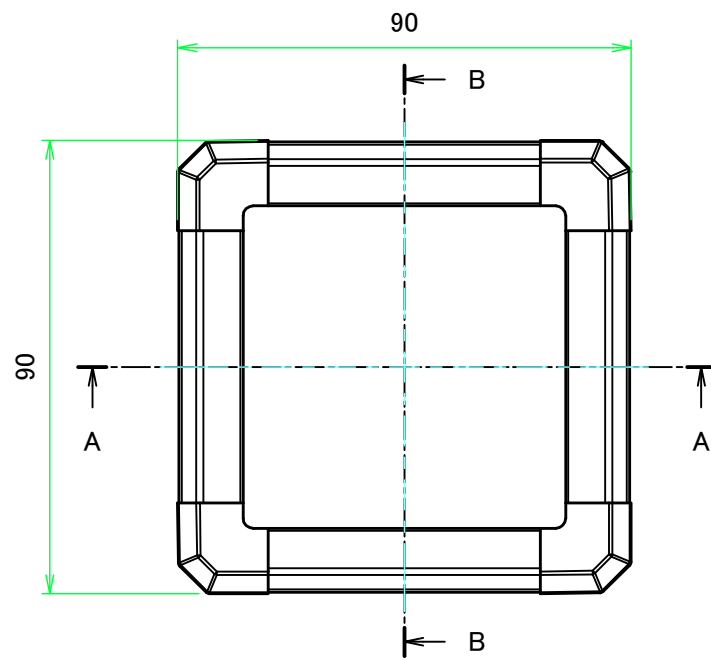
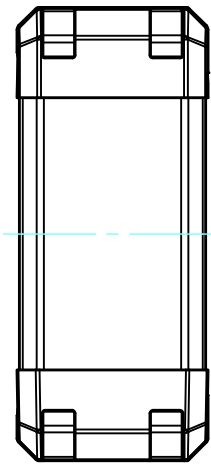

フレーム4側 / Frame4 side

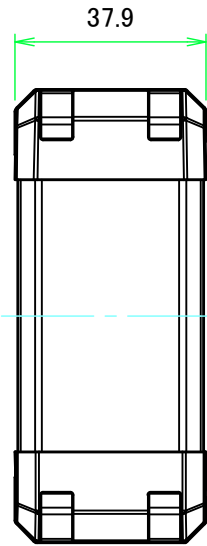

B-B (1:1.5)

有効寸法 / Max dim. 31.5

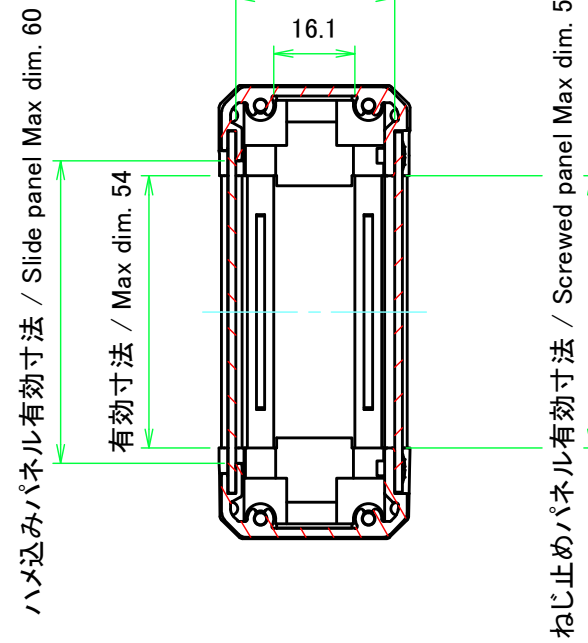

フレーム2側 / Frame2 side

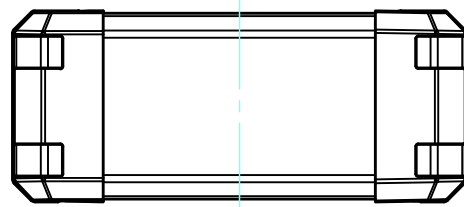

A-A (1:1.5)

ハメ込みパネル有効寸法 / Slide panel Max dim. 60

有効寸法 / Max dim. 54

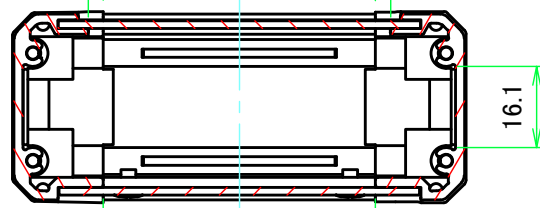

ねじ止めパネル有効寸法 / Screwed panel Max dim. 54

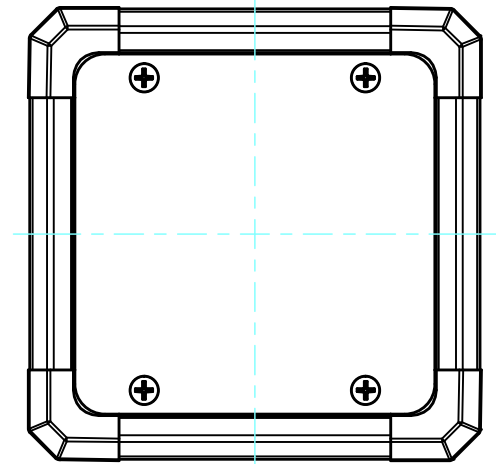

株式会社タカチ電機工業 TAKACHI ELECTRONICS ENCLOSURE CO., LTD.		品名/Title コントロールボックス ALUMINIUM CONTROL BOX	尺度/Scale 1:1.5
承認/Approved	検図/Checked	製図/Created	
	大江	常山	作成日/Date 2017/05/09
			2 / 7

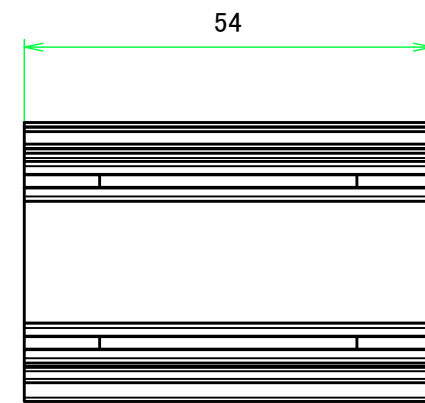
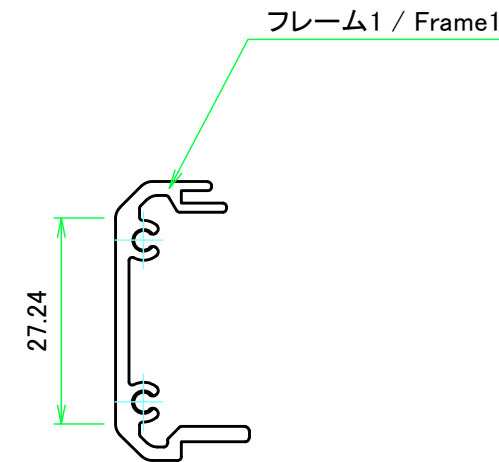
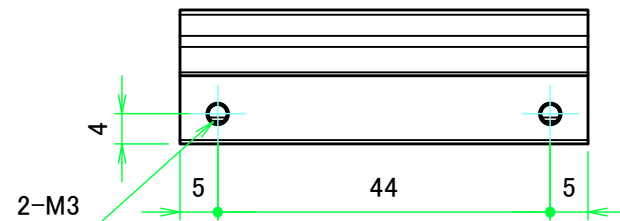
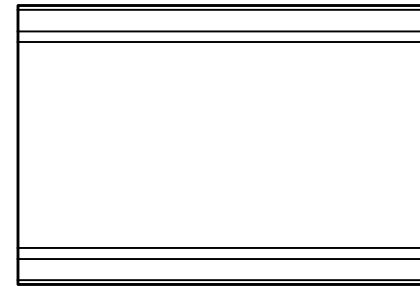
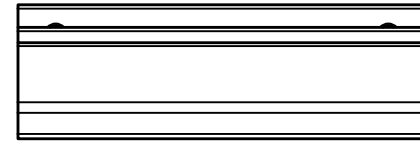
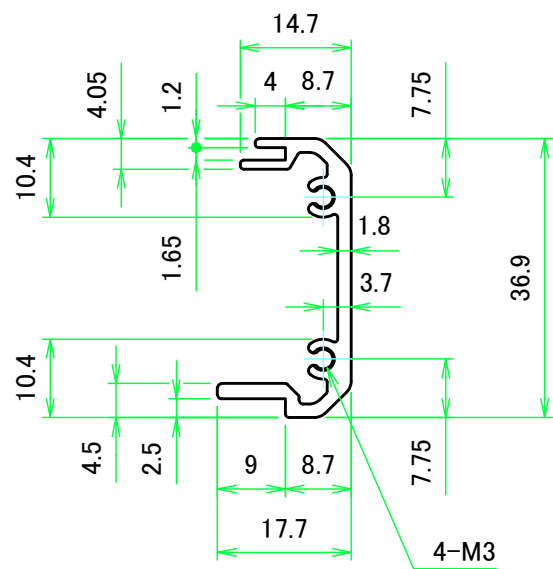

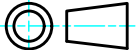
 株式会社タカチ電機工業 TAKACHI ELECTRONICS ENCLOSURE CO., LTD.		品名/Title フレーム1 Frame1	 尺度/Scale 1:1
承認/Approved	検図/Checked	製図/Created	
	大江	常山	作成日/Date 2017/05/09
			3 / 7

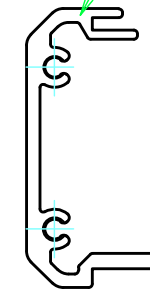
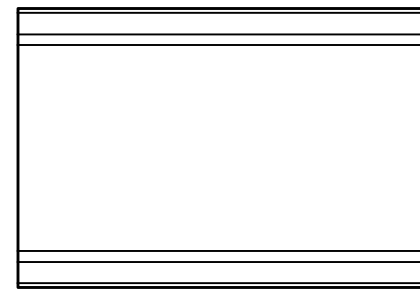
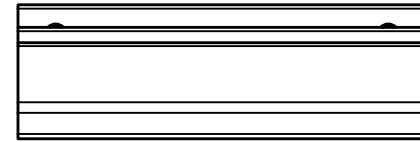
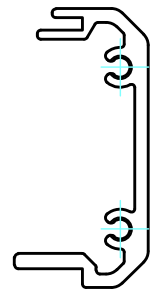

フレーム2 / Frame2

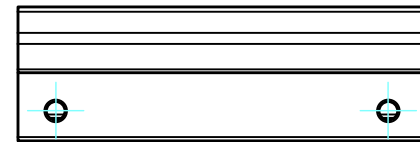
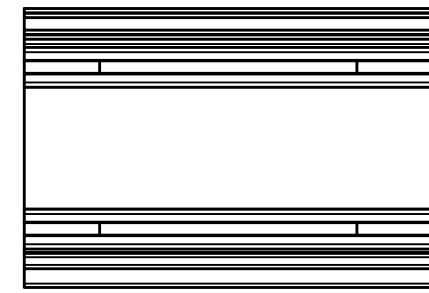

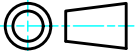
 株式会社タカチ電機工業 TAKACHI ELECTRONICS ENCLOSURE CO., LTD.		品名/Title フレーム2 Frame2	
承認/Approved	検図/Checked 大江	製図/Created 常山	尺度/Scale 1:1
		型番/Product number H37.9 - W90	4 / 7
		作成日/Date 2017/05/09	

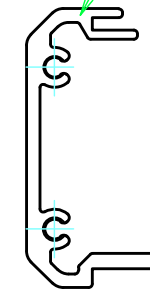
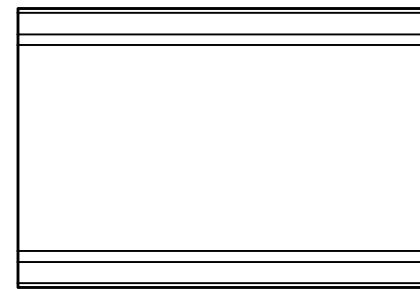
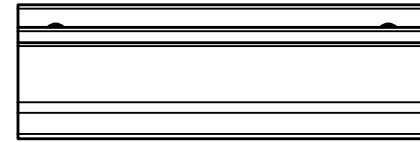
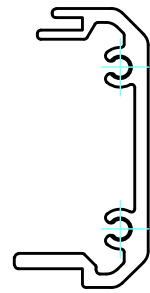

フレーム3 / Frame3

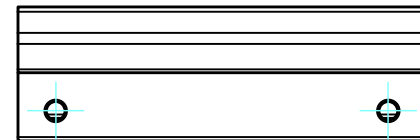
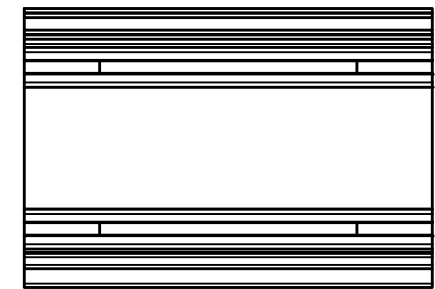

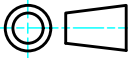
 株式会社タカチ電機工業 TAKACHI ELECTRONICS ENCLOSURE CO., LTD.		品名/Title フレーム3 Frame3	
承認/Approved	検図/Checked 大江	製図/Created 常山	尺度/Scale 1:1
		型番/Product number H37.9 - D90	5 / 7
		作成日/Date 2017/05/09	

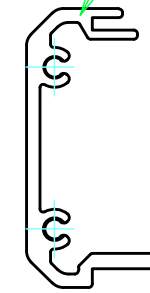
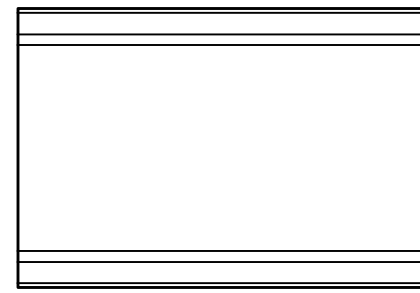
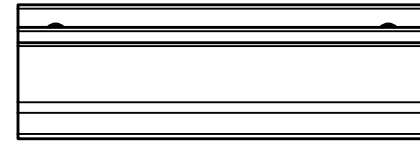
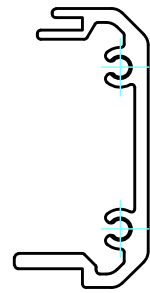

フレーム4 / Frame4

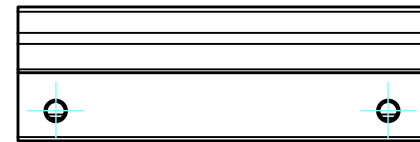
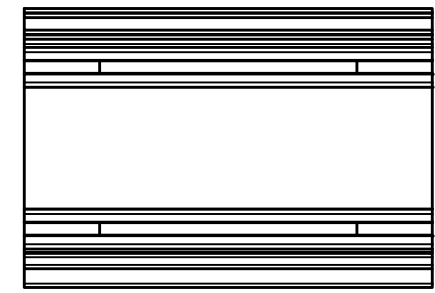

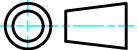
 株式会社タカチ電機工業 TAKACHI ELECTRONICS ENCLOSURE CO., LTD.		品名/Title フレーム4 Frame4		
承認/Approved	検図/Checked	製図/Created	型番/Product number H37.9 - D90	
	大江	常山	作成日/Date 2017/05/09	6 / 7

ハメ込みパネル / Slide panel

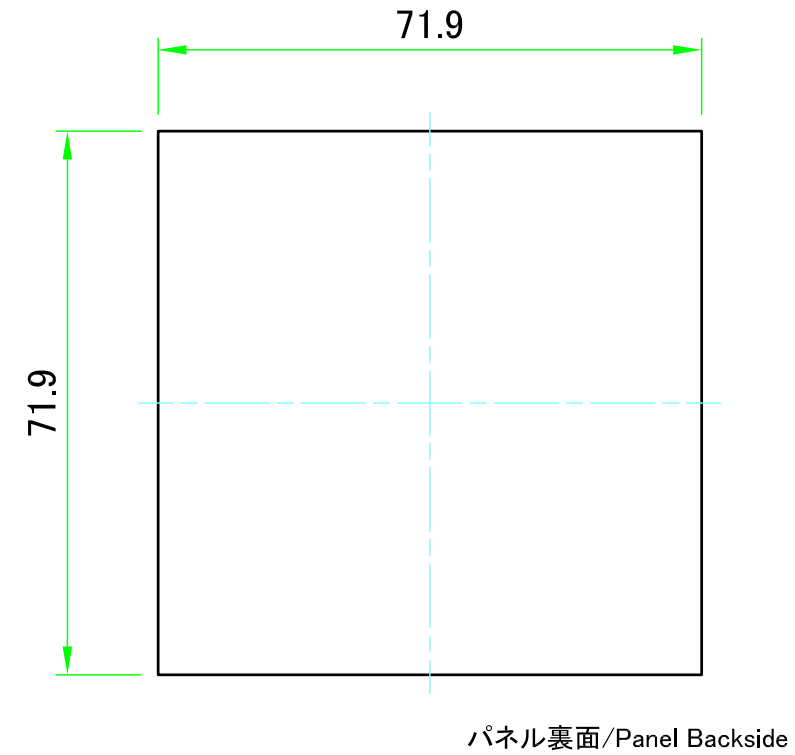
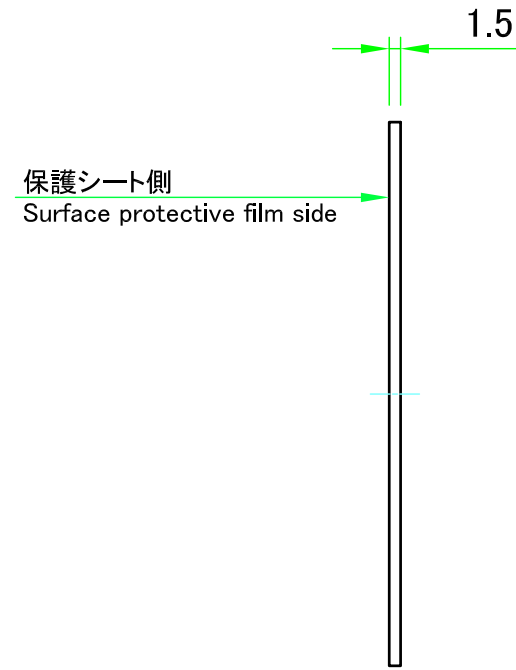
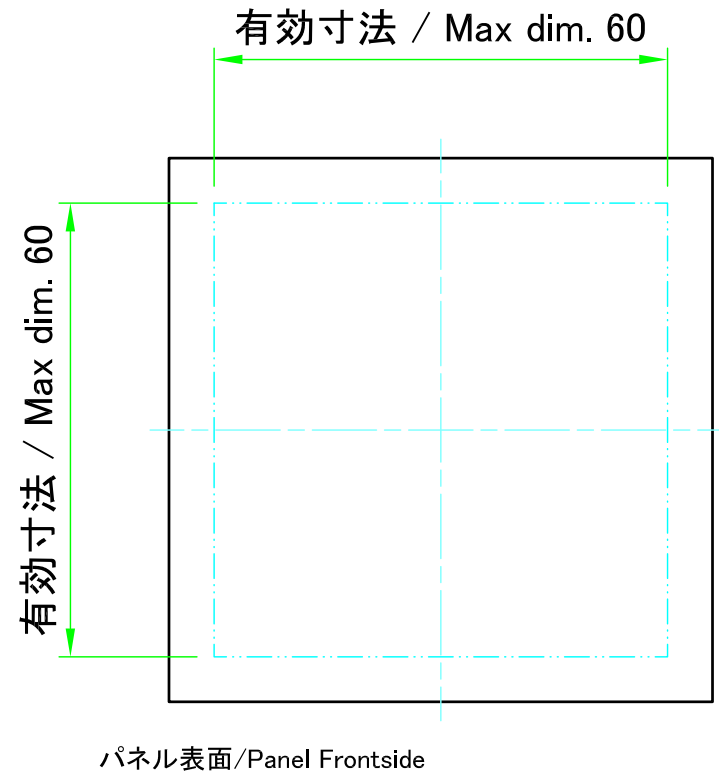

ねじ止めパネル / Screwed panel

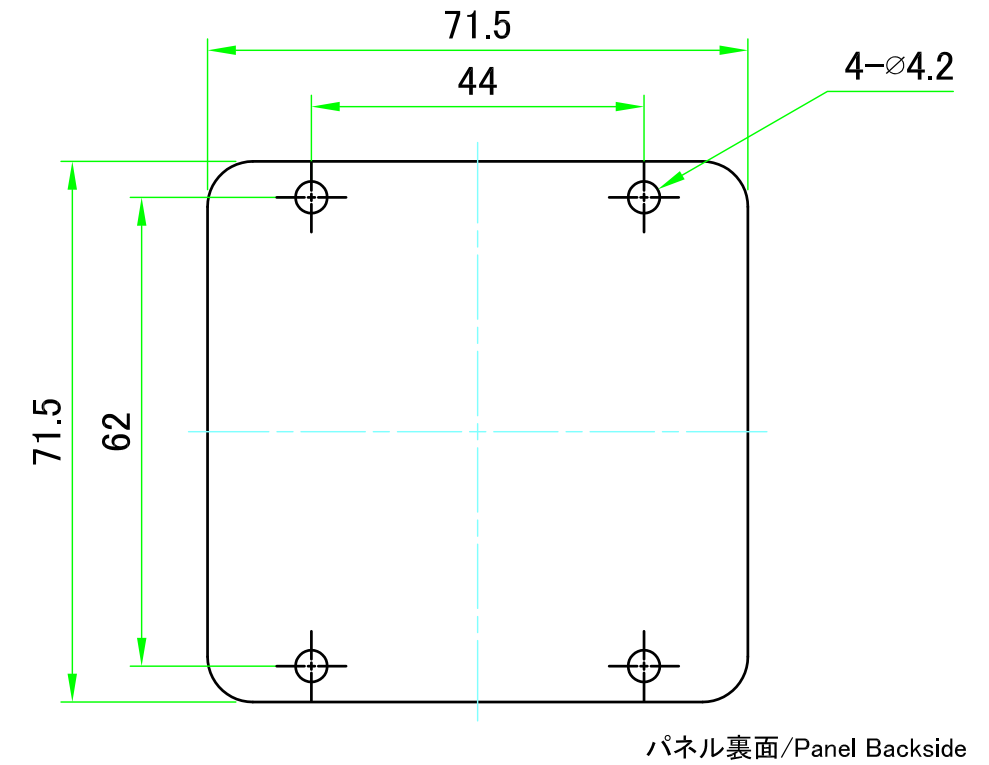
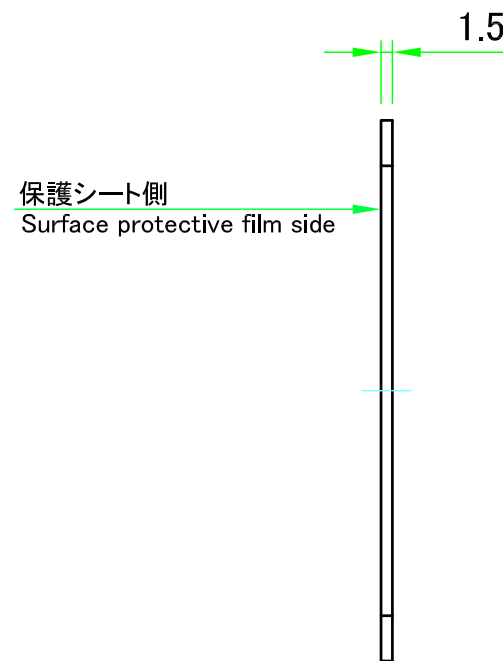
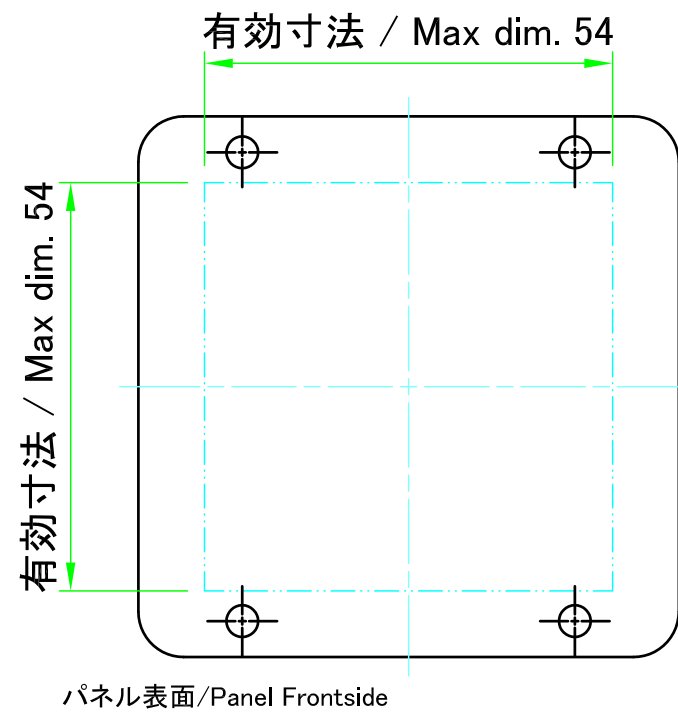

株式会社タカチ電機工業 TAKACHI ELECTRONICS ENCLOSURE CO., LTD.			品名 / Title パネル Panel	尺度 / Scale 1:1
承認 / Approved	検図 / Checked	製図 / Created	型番 / Product number W90 - D90	
中根	大江	常山	作成日 / Date 2020/07/08	7 / 7