

構成内容 / Components				
No.	名称 / Part name	数量 / Pcs	材質 / Material	色・表面処理 / Color・Finish
1	フレーム Frame	4	アルミ押出材 A6063S-T5 Extruded aluminium A6063S-T5	シルバー、ブラック・アルマイト & クリア塗装 Silver, black・Anodized & clear coated
2	コーナーブロック Corner block	4	ABS樹脂 UL94HB ABS UL94HB	ライトグレー、ブラック Light gray, Black
3	コーナーキャップ / Blind plug	8	エラストマ / TPE	ライトグレー、ブラック / Light gray, Black
4	ハメ込みパネル / Slide panel	1	アルミ板 / Aluminium A1100P t=1.5 アルミ板 / Aluminium A1100P t=1.5	シルバーアルマイト / Silver・Anodized ブラック・塗装 / Black・Painted
5	ねじ止めパネル / Screwed panel	1	アルミ板 / Aluminium A1100P t=1.5 アルミ板 / Aluminium A1100P t=1.5	シルバーアルマイト / Silver・Anodized ブラック・塗装 / Black・Painted
6	取付ビス(M4 x 15 ナベ) Screw(M4 - 15 Pan head)	16	鉄 Steel	三価クロメート Trivalent chromate
7	パネル取付ビス(十字穴台形ビスM3 x 5) Screw(Original trapezoid head M3 - 5)	4	鉄 Steel	ニッケルメッキ、三価黒クロメート Nickel plated, Black trivalent chromate

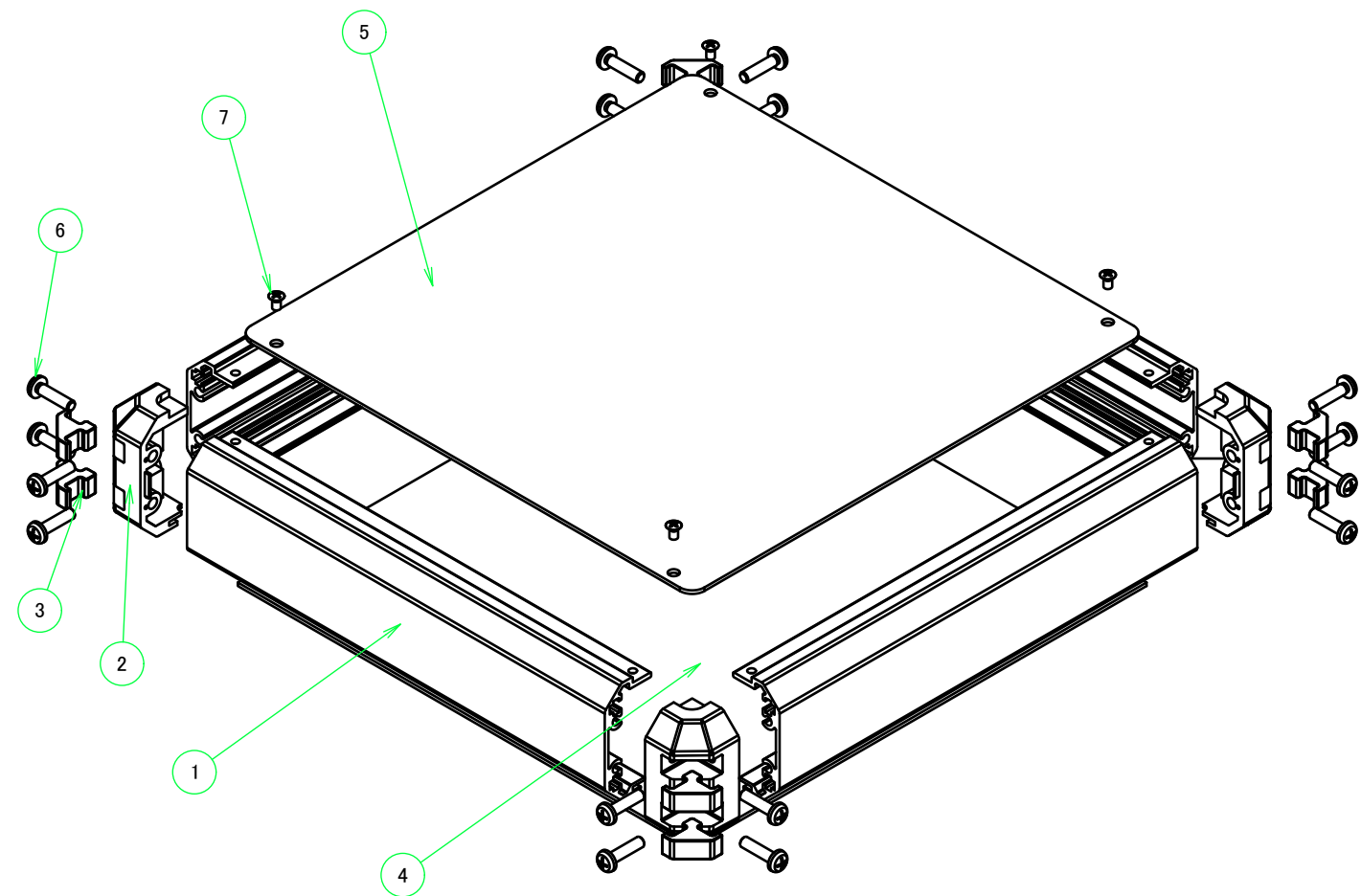
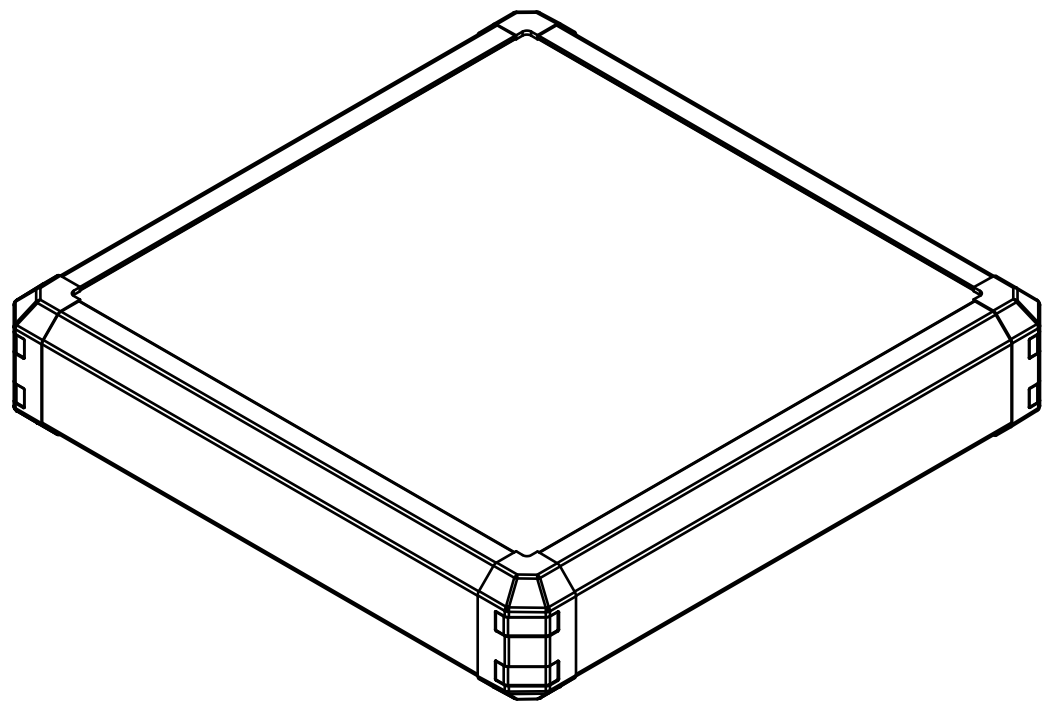
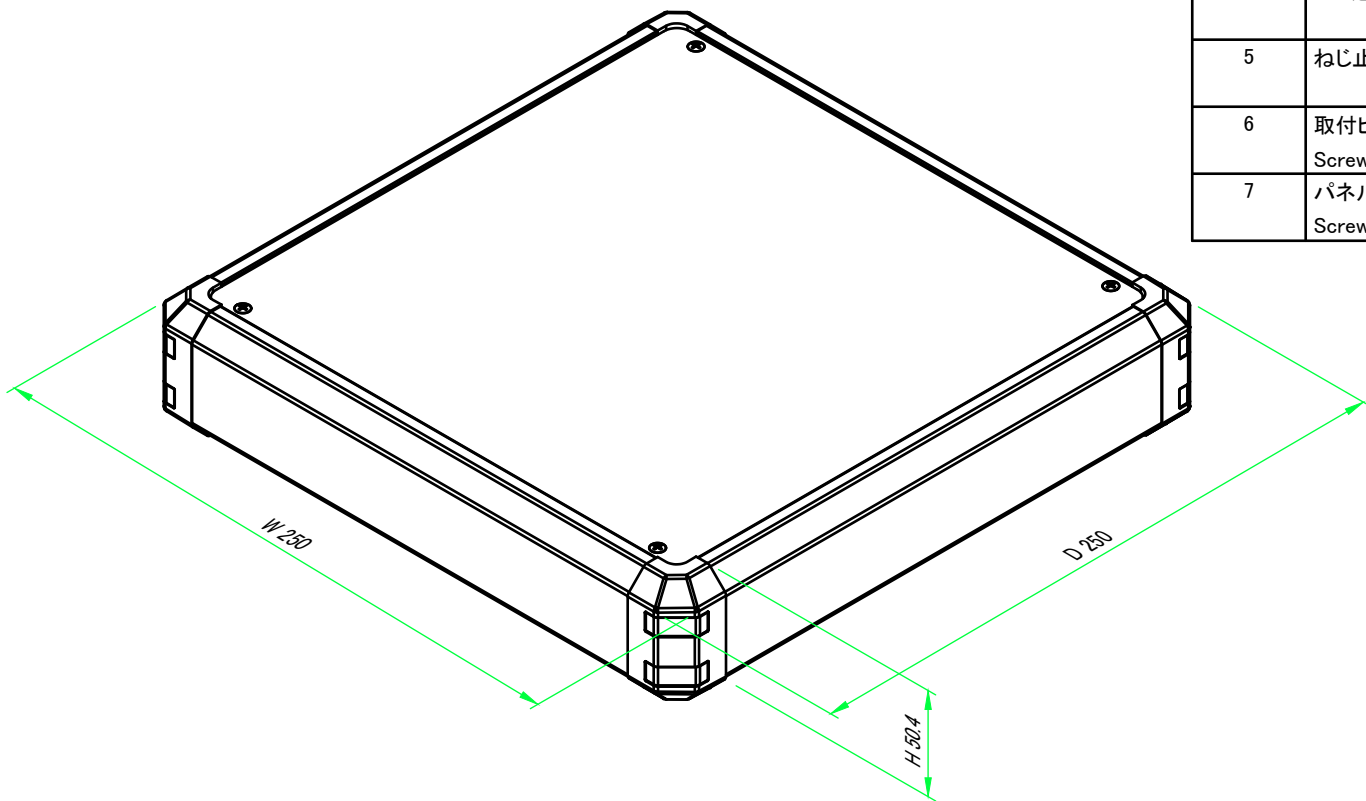

色仕様(型番末尾□) / Color Type(End of product number□)			
記号 / Code	パネル / Panel	フレーム / Freme	コーナー / Corner
G S	シルバー / Silver	シルバー / Silver	ライトグレー / Light gray
B S	シルバー / Silver	シルバー / Silver	ブラック / Black
B X	シルバー / Silver	ブラック / Black	ブラック / Black
B B	ブラック / Black	ブラック / Black	ブラック / Black

株式会社タカチ電機工業 TAKACHI ELECTRONICS ENCLOSURE CO., LTD.			品名/Title コントロールボックス ALUMINIUM CONTROL BOX	
承認/Approved 中根	検図/Checked 大江	製図/Created 常山	型番/Product number FC5-25-25□	
			作成日/Date 2022/11/01	1 / 7

外視図, 内視図 / External View, Internal View

フレーム1側 / Frame1 side

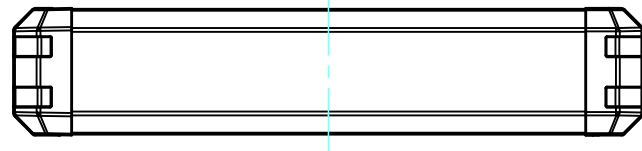

フレーム3側 / Frame3 side

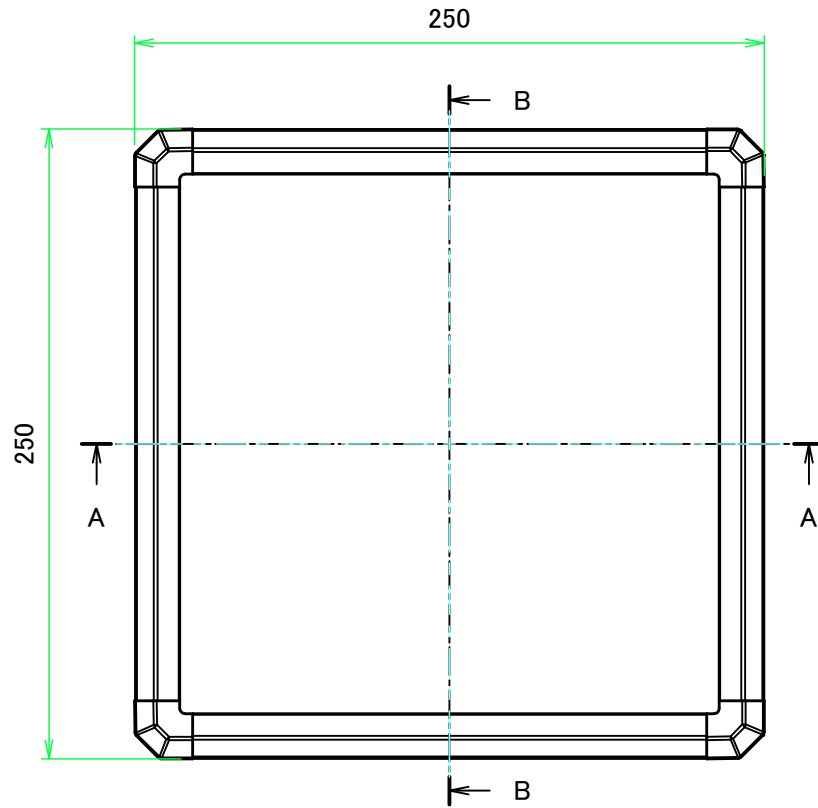
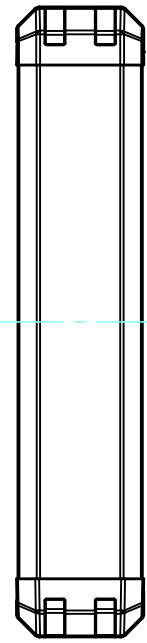

フレーム4側 / Frame4 side

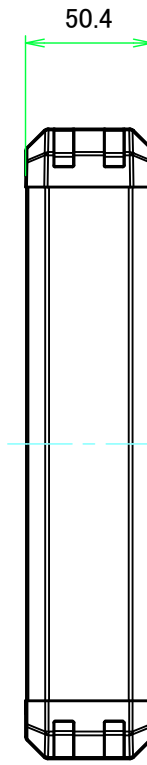

B-B (1:3)

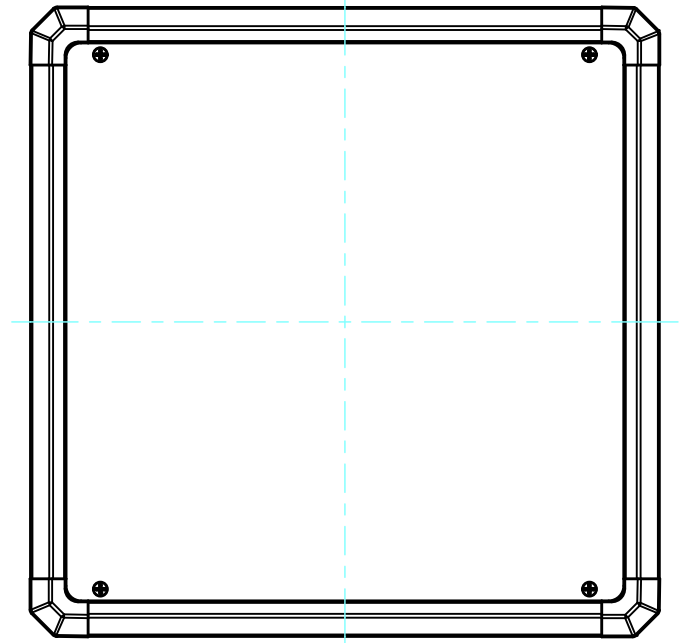
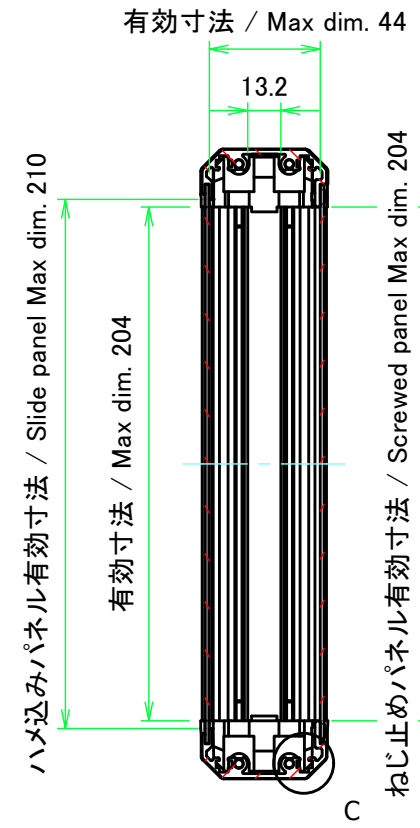

フレーム2側 / Frame2 side

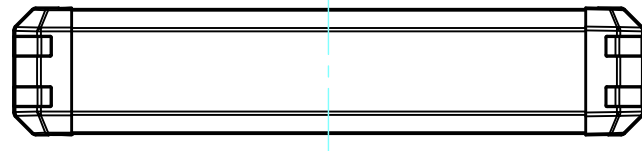

A-A (1:3)

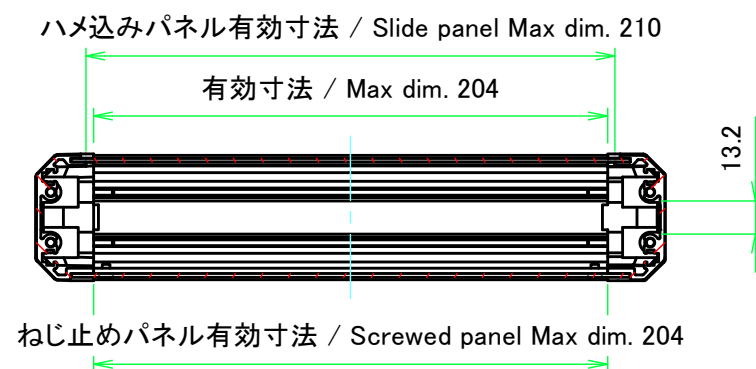

C : フレーム拡大図 / Frame cross-section

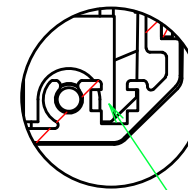

ナットレール / Nut rail

スライドナット用溝

別売オプション品 スライドナット FZ-3 を入れる事が出来ます。

Groove for slide nut

Slide nut FZ-3 (sold separately as optional parts) can be inserted.

株式会社タカチ電機工業 TAKACHI ELECTRONICS ENCLOSURE CO., LTD.			品名/Title コントロールボックス ALUMINIUM CONTROL BOX	尺度/Scale 1:3
承認/Approved	検図/Checked	製図/Created	型番/Product number FC5-25-25□	
	大江	常山	作成日/Date 2017/05/18	2 / 7

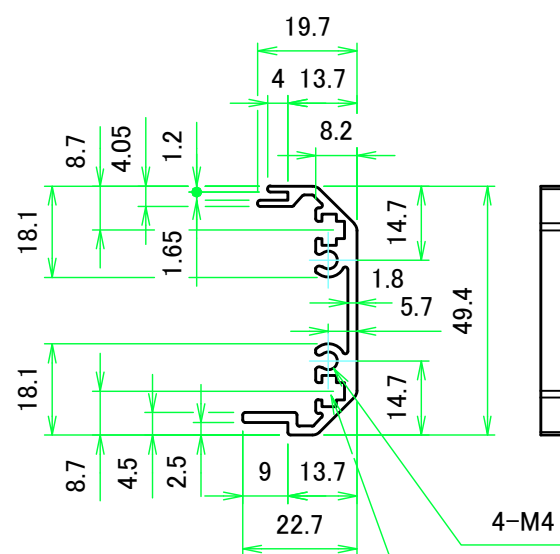
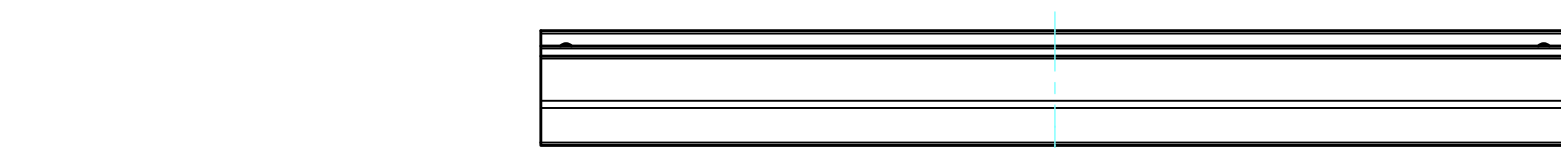

ナットレール / Nut rail

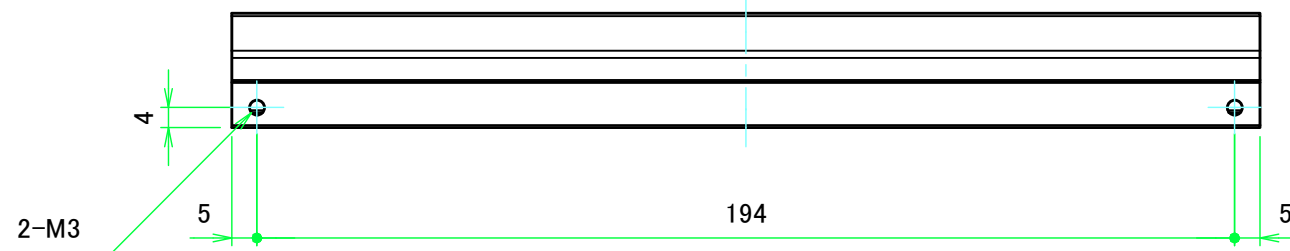
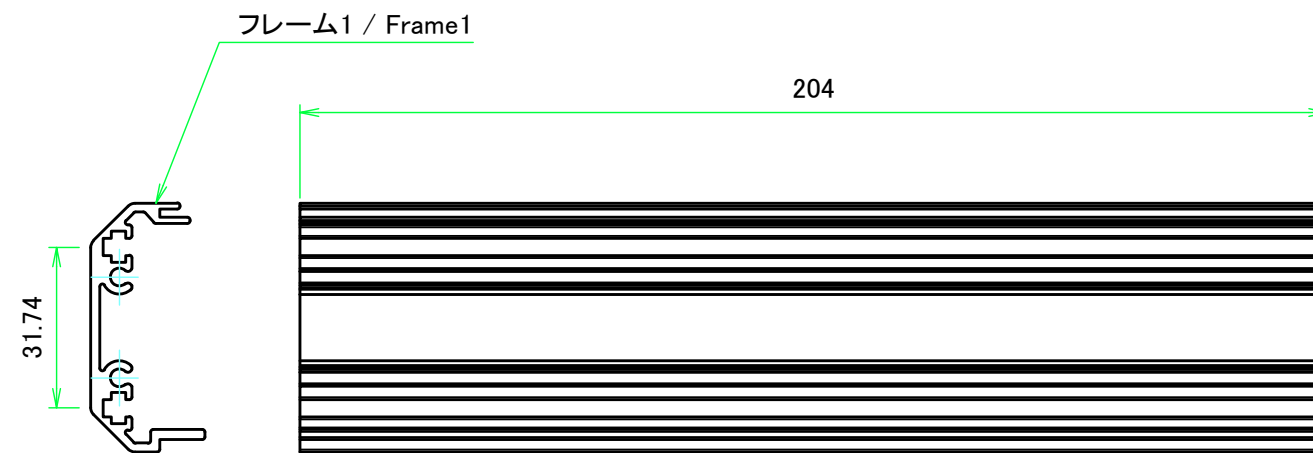
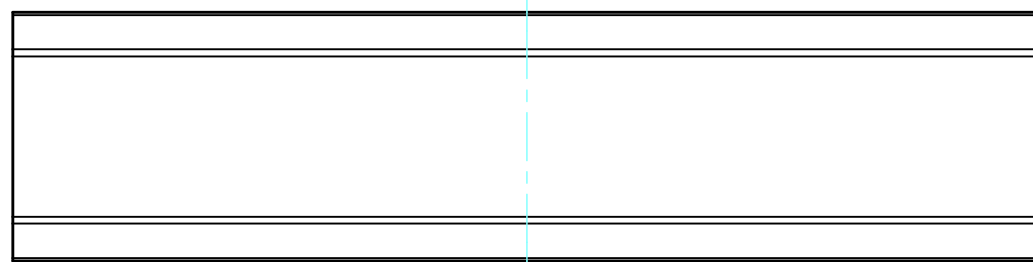

株式会社タカチ電機工業 TAKACHI ELECTRONICS ENCLOSURE CO., LTD.		品名/Title フレーム1 Frame1	尺度/Scale 1:1.5
承認/Approved	検図/Checked	製図/Created	
	大江	常山	作成日/Date 2017/05/18
			3 / 7

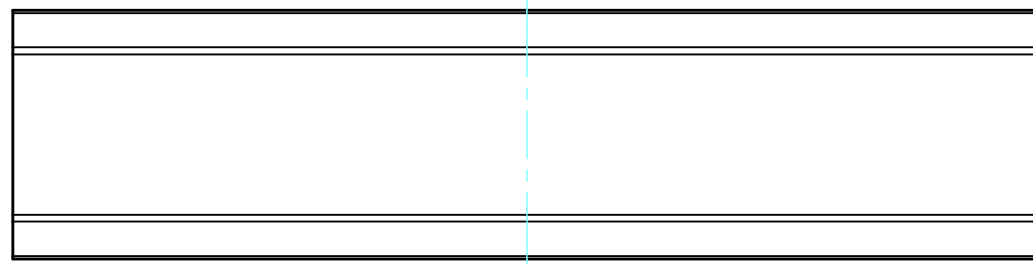
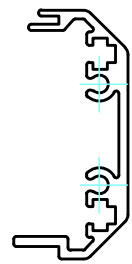

フレーム2 / Frame2

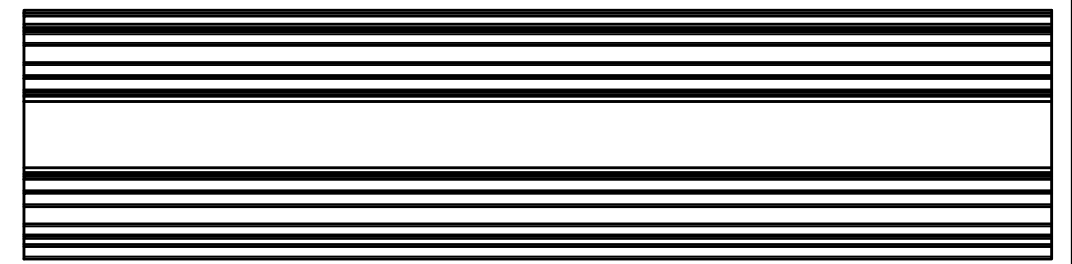
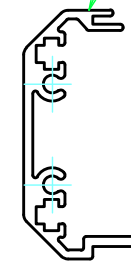

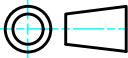
 株式会社タカチ電機工業 TAKACHI ELECTRONICS ENCLOSURE CO., LTD.		品名/Title フレーム2 Frame2	
承認/Approved	検図/Checked	製図/Created	
	大江	常山	型番/Product number H50.4 - W250
			作成日/Date 2017/05/18
			4 / 7

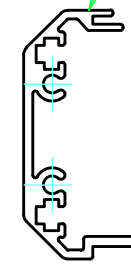
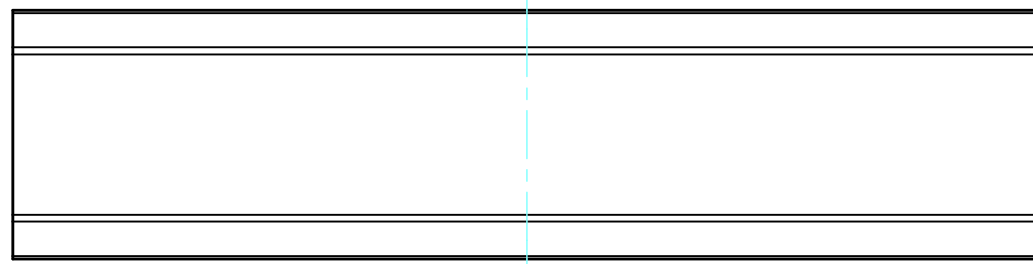
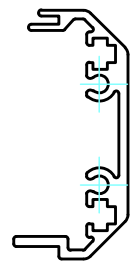

フレーム3 / Frame3

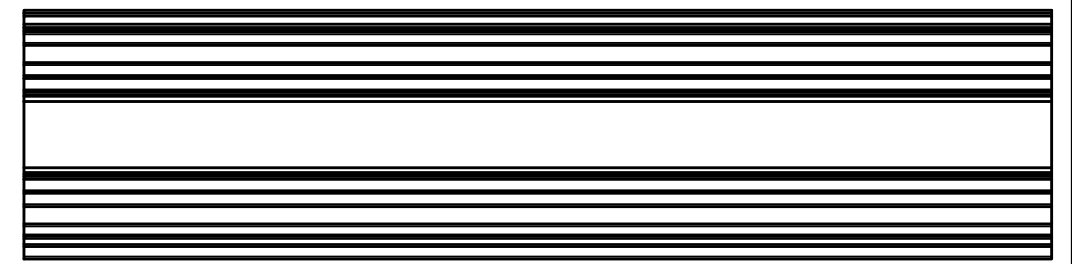

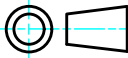
 株式会社タカチ電機工業 TAKACHI ELECTRONICS ENCLOSURE CO., LTD.		品名/Title フレーム3 Frame3	
承認/Approved	検図/Checked	製図/Created	
	大江	常山	型番/Product number H50.4 - D250
			作成日/Date 2017/05/18
			5 / 7

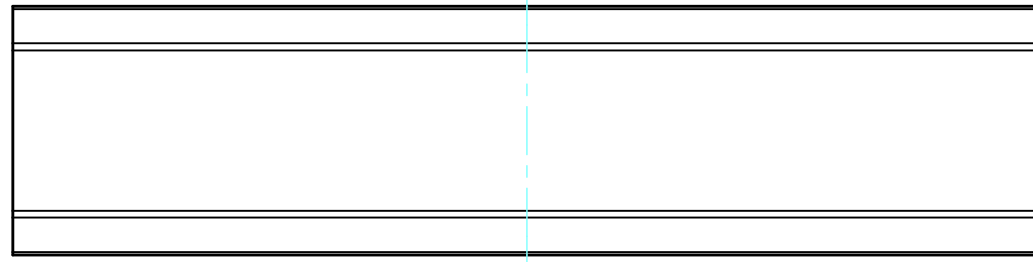
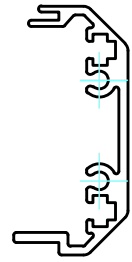

フレーム4 / Frame4

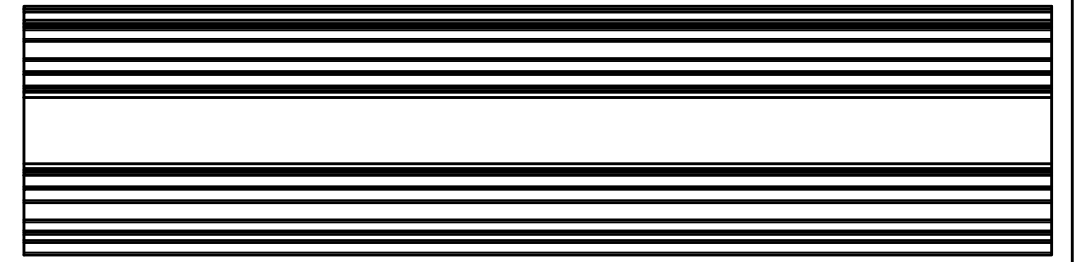
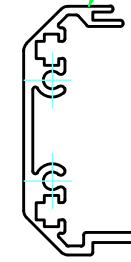

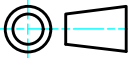
 株式会社タカチ電機工業 TAKACHI ELECTRONICS ENCLOSURE CO., LTD.		品名/Title フレーム4 Frame4	
承認/Approved	検図/Checked 大江	製図/Created 常山	尺度/Scale 1:1.5
		型番/Product number H50.4 - D250	6 / 7
		作成日/Date 2017/05/18	

ハメ込みパネル / Slide panel

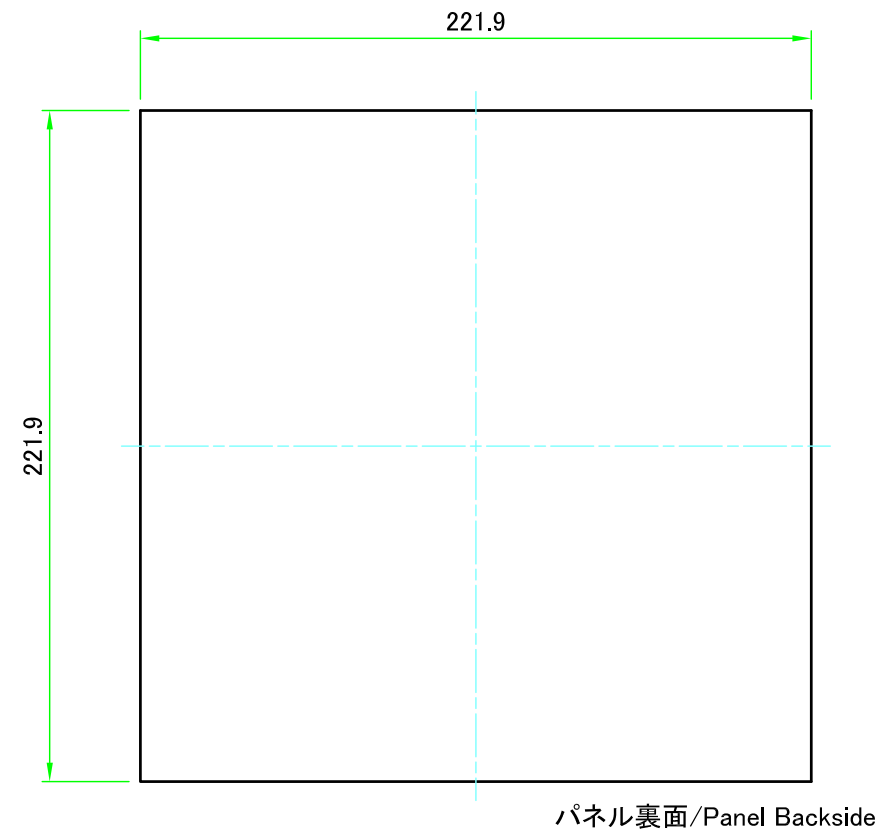
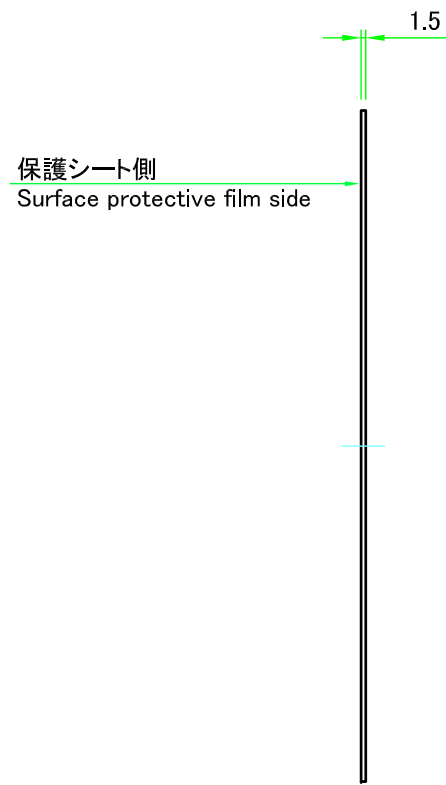
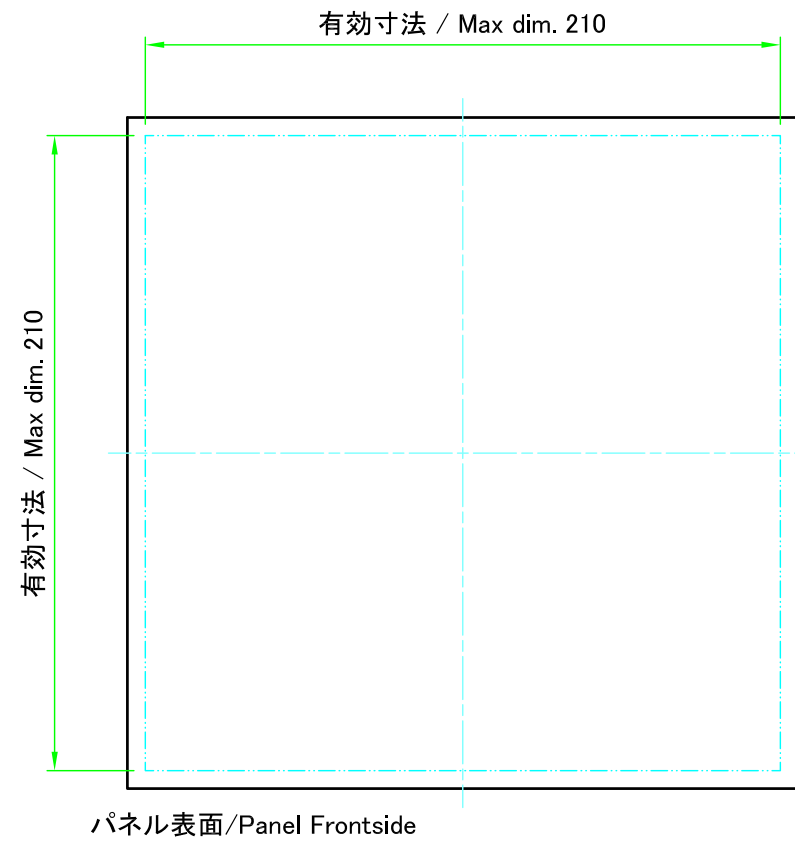

ねじ止めパネル / Screwed panel

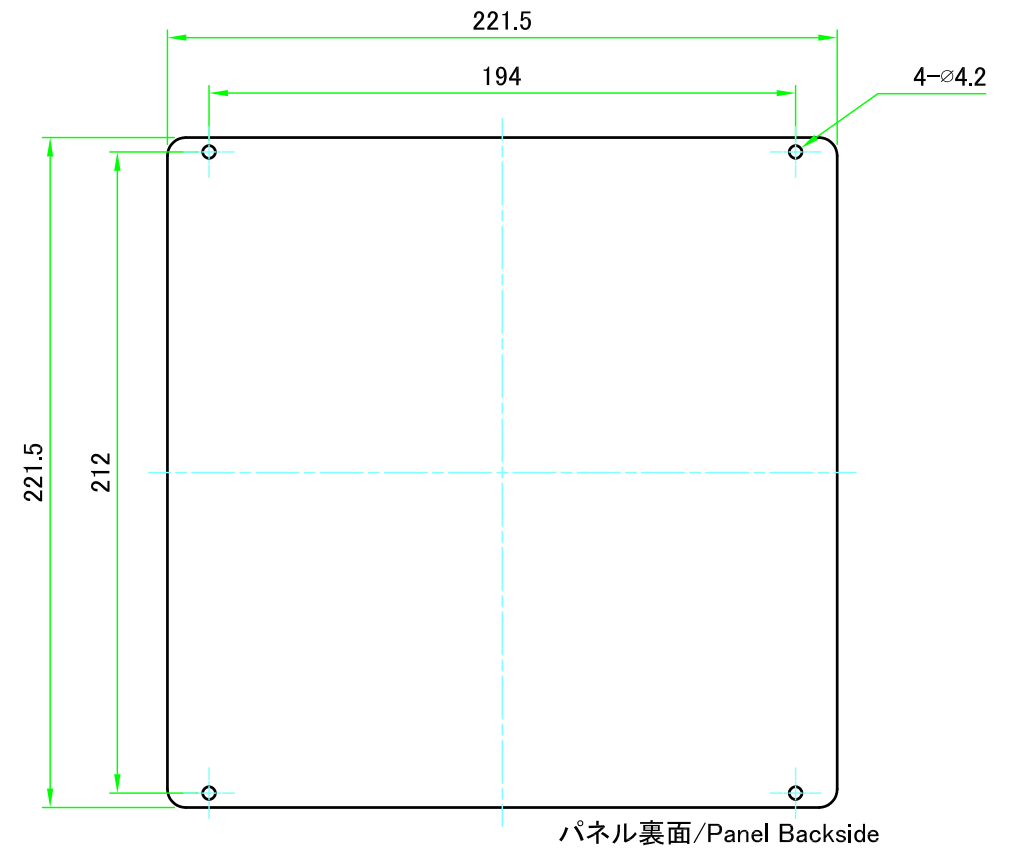
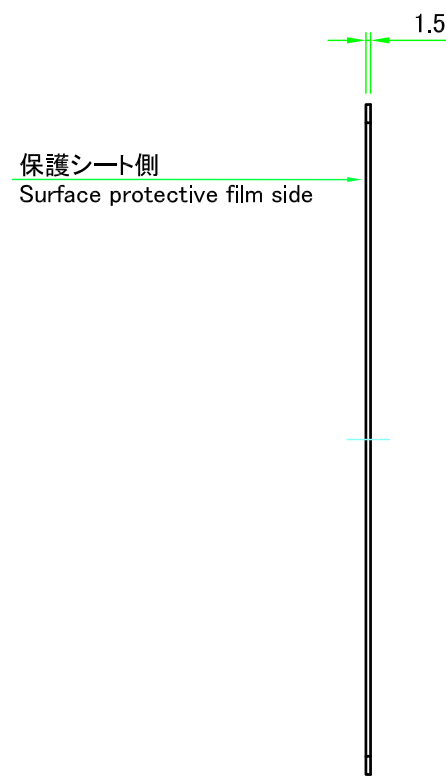
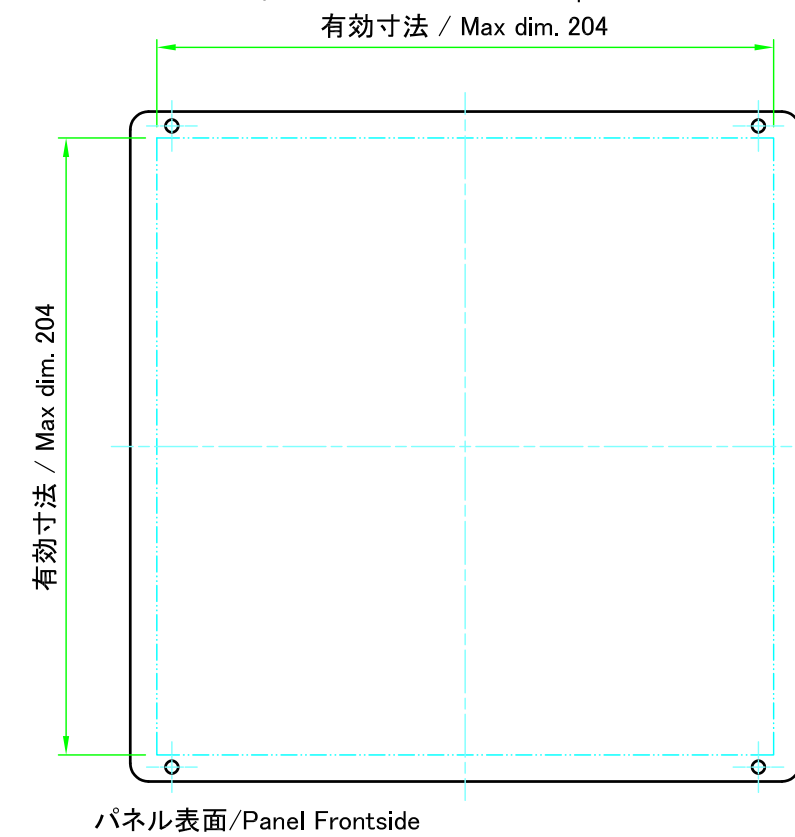

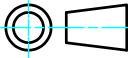
株式会社タカチ電機工業 TAKACHI ELECTRONICS ENCLOSURE CO., LTD.			品名 / Title パネル Panel	 尺度 / Scale 1:2.5
承認 / Approved 中根	検図 / Checked 大江	製図 / Created 常山	型番 / Product number W250 - D250 作成日 / Date 2020/07/10	
				7 / 7