



色仕様(型番末尾口) / Color Type(End of product number口)			
記号 / Code	パネル / Panel	フレーム / Freme	コーナ / Corner
G S	シルバー / Silver	シルバー / Silver	ライトグレー / Light gray
B S	シルバー / Silver	シルバー / Silver	ブラック / Black
B X	シルバー / Silver	ブラック / Black	ブラック / Black
B B	ブラック / Black	ブラック / Black	ブラック / Black

 株式会社タカチ電機工業 TAKACHI ELECTRONICS ENCLOSURE CO., LTD.			品名/Title コントロールボックス ALUMINIUM CONTROL BOX	 尺度/Scale 1:4.5
承認/Approved 中根	検図/Checked 大江	製図/Created 常山	型番/Product number FC8-60-40□ 作成日/Date 2022/11/01	

外視図，内視図 / External View, Internal View

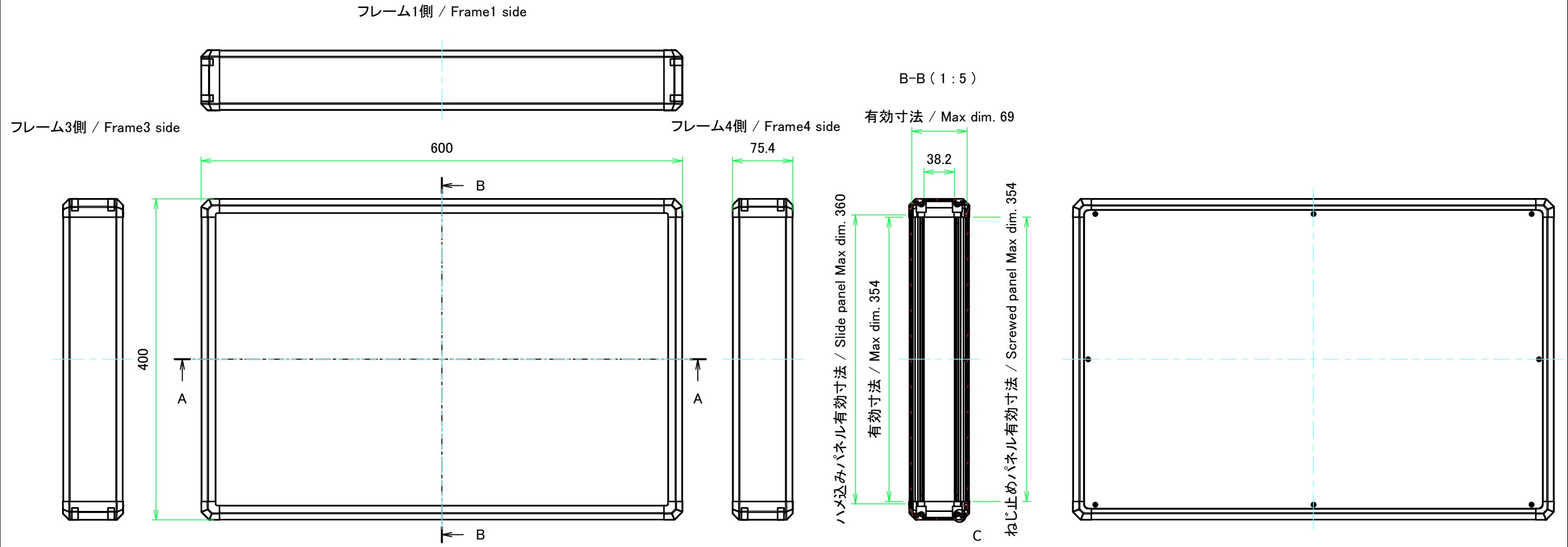

フレーム2側 / Frame2 side

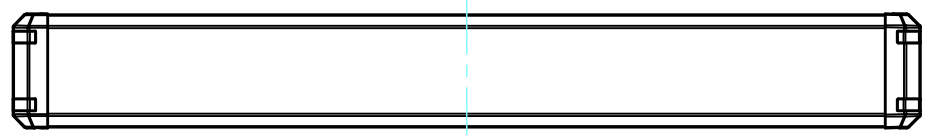

A-A (1:5)

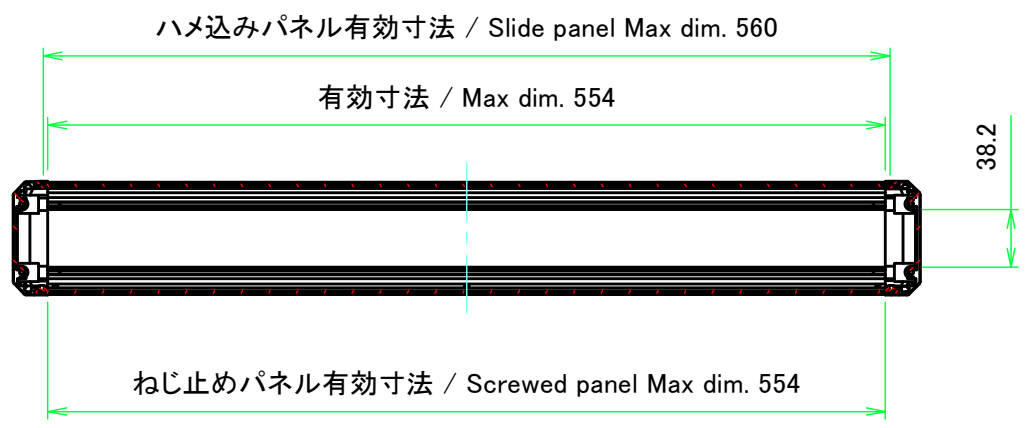

C : フレーム拡大図 / Frame cross-section

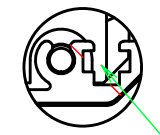

ナットレール / Nut rail

スライドナット用溝
別売オプション品 スライドナット FZ-3 を入れる事が出来ます。
Groove for slide nut
Slide nut FZ-3 (sold separately as optional parts) can be inserted.

株式会社タカチ電機工業 TAKACHI ELECTRONICS ENCLOSURE CO., LTD.			品名/Title コントロールボックス ALUMINIUM CONTROL BOX	尺度/Scale 1:5
承認/Approved	検図/Checked	製図/Created	型番/Product number FC8-60-40□	
	大江	常山	作成日/Date 2017/07/27	2 / 7

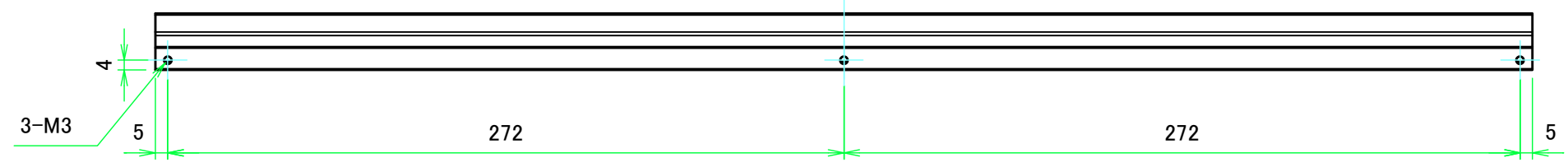
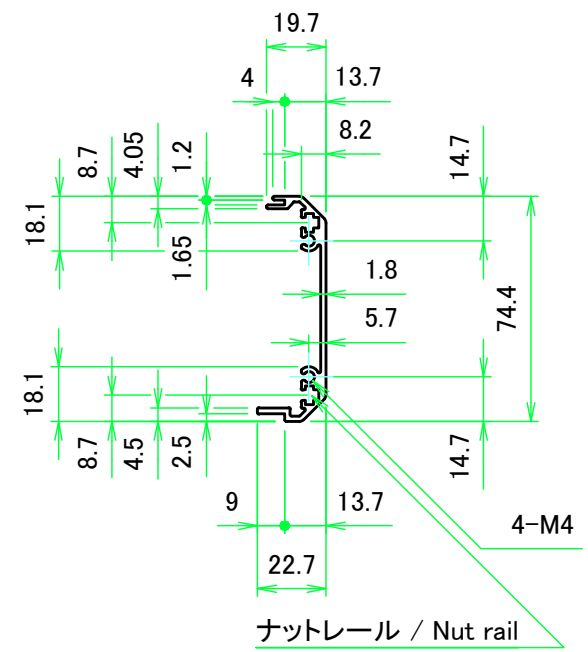
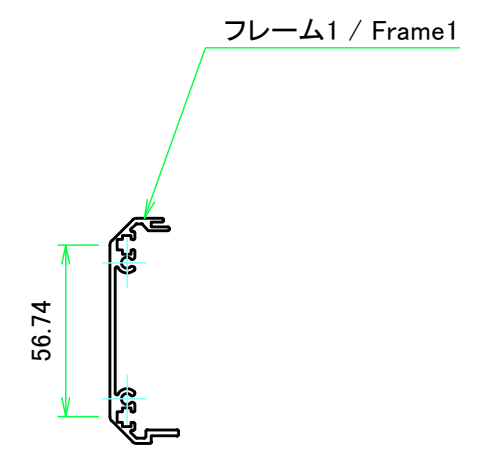
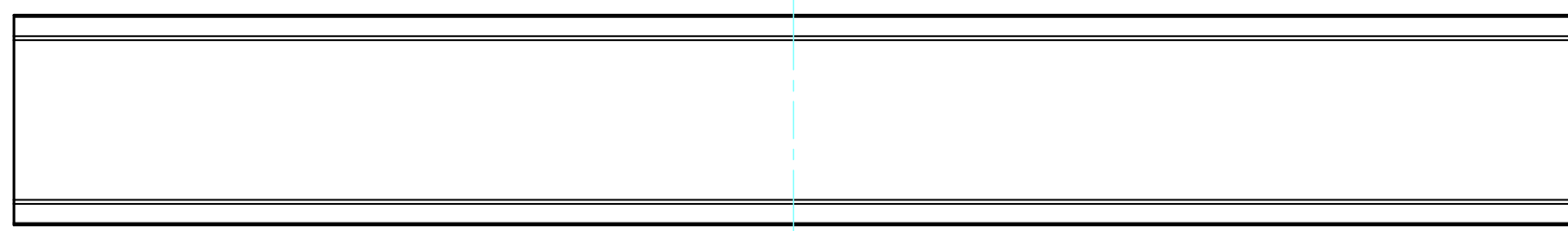
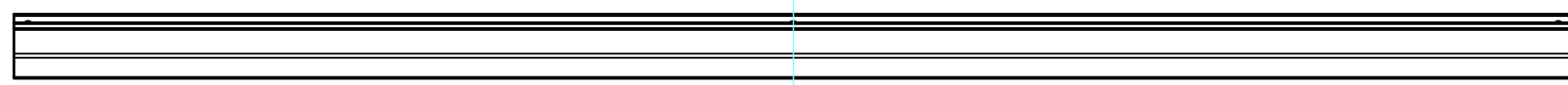
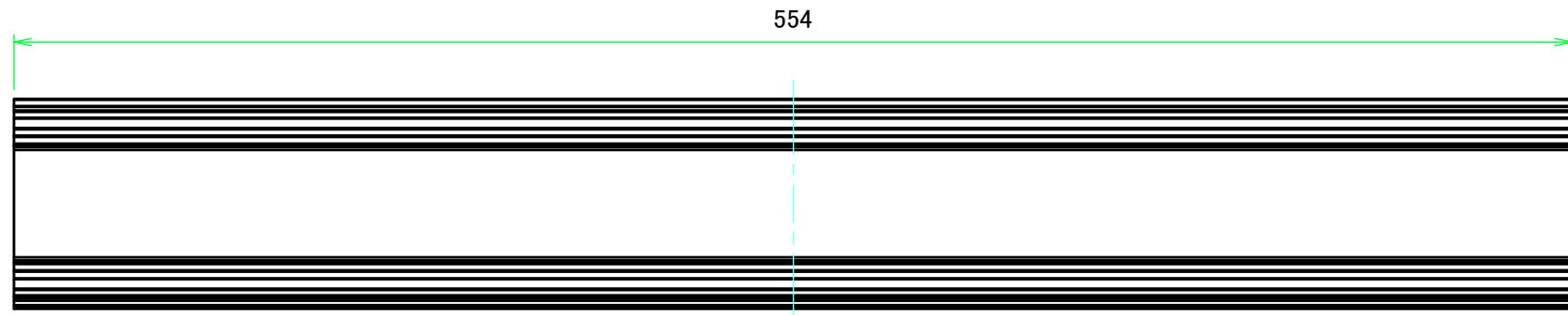

株式会社タカチ電機工業 TAKACHI ELECTRONICS ENCLOSURE CO., LTD.			品名/Title フレーム1 Frame1	尺度/Scale 1:2.5
承認/Approved	検図/Checked	製図/Created	型番/Product number H75.4 - W600	
	大江	常山	作成日/Date 2017/07/27	3 / 7

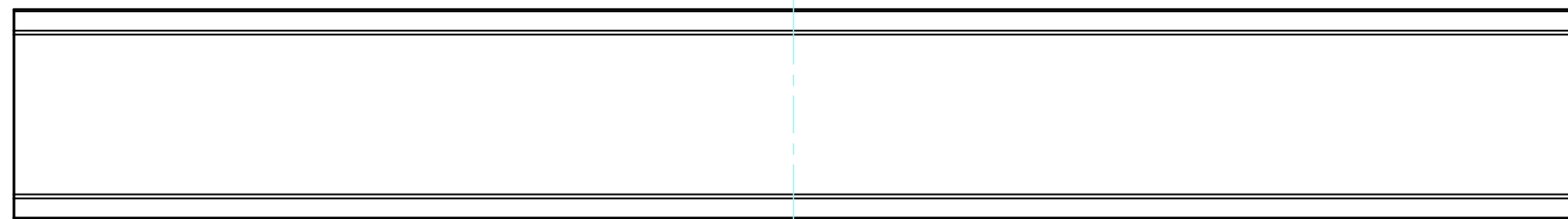
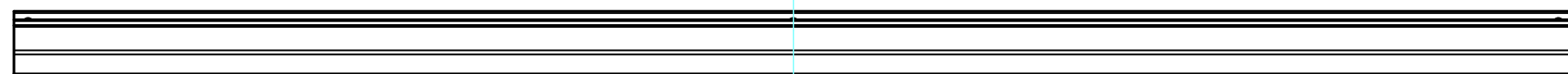
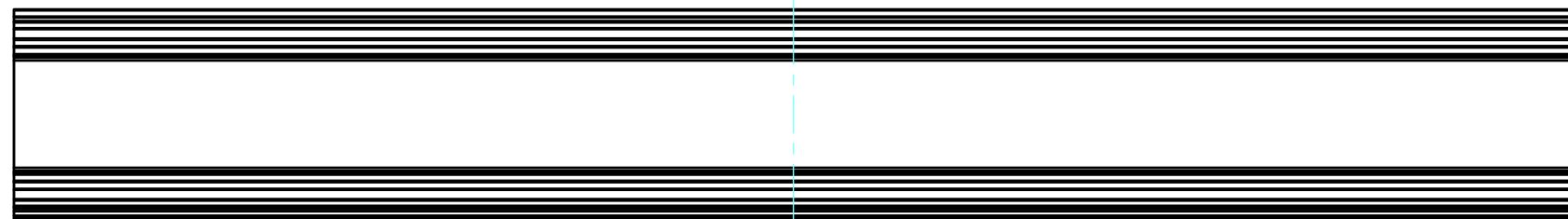

フレーム2 / Frame2

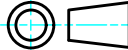
 株式会社タカチ電機工業 TAKACHI ELECTRONICS ENCLOSURE CO., LTD.		品名/Title フレーム2 Frame2	
承認/Approved	検図/Checked 大江	製図/Created 常山	尺度/Scale 1:2.5
		型番/Product number H75.4 - W600	4 / 7
		作成日/Date 2017/07/27	

354

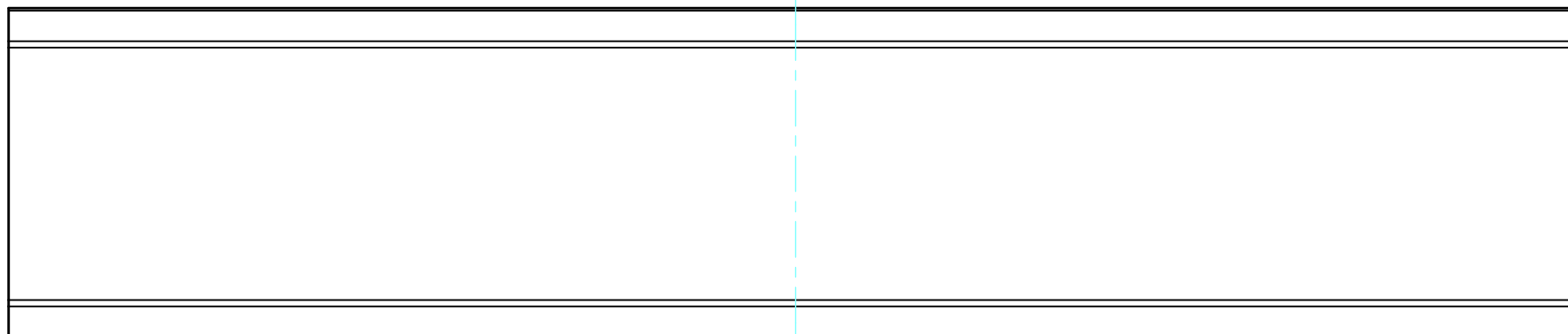
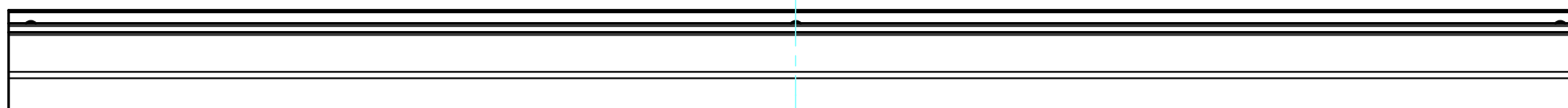
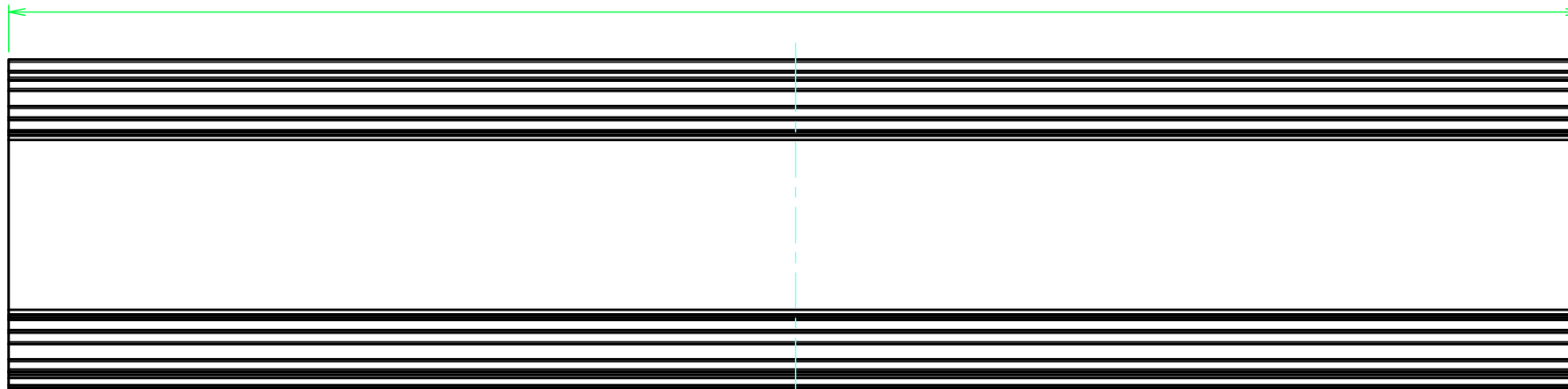

フレーム3 / Frame3

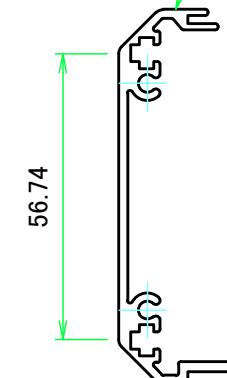

56.74

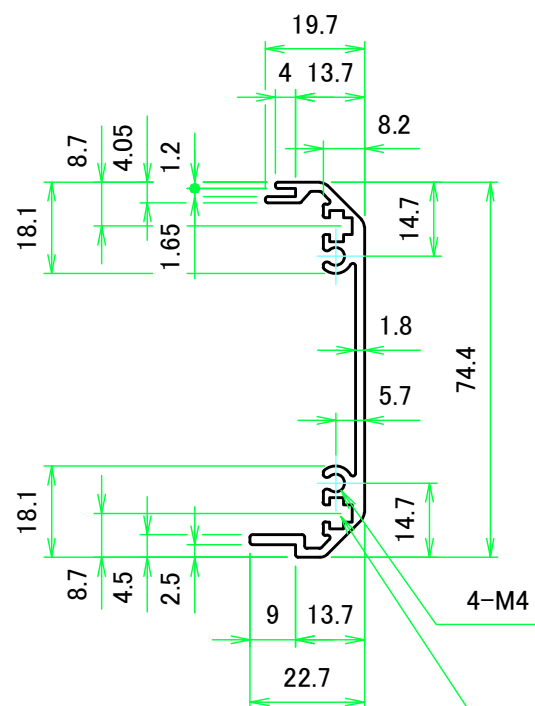

ナットレール / Nut rail

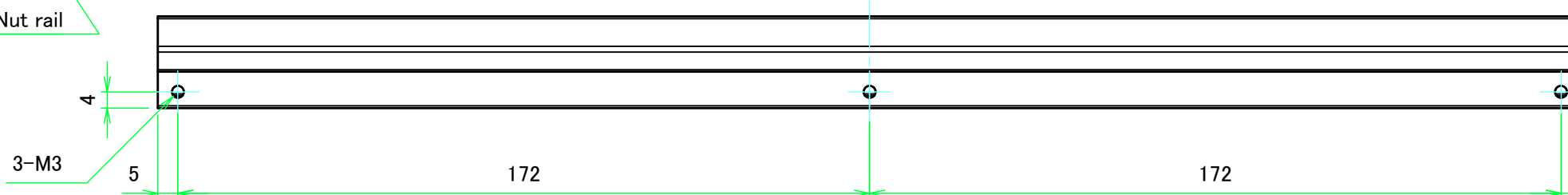

3-M3

4

172

172

5

TAKACHI 株式会社タカチ電機工業 TAKACHI ELECTRONICS ENCLOSURE CO., LTD.			品名/Title フレーム3 Frame3	
承認/Approved	検図/Checked	製図/Created	型番/Product number H75.4 - D400	
	大江	常山	作成日/Date 2017/07/27	5 / 7

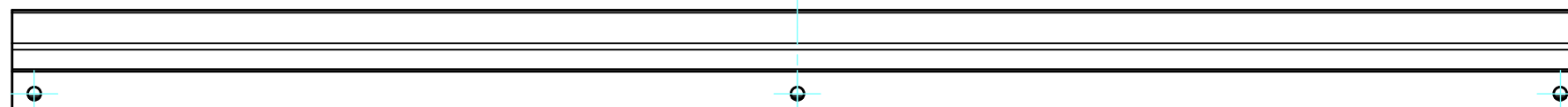
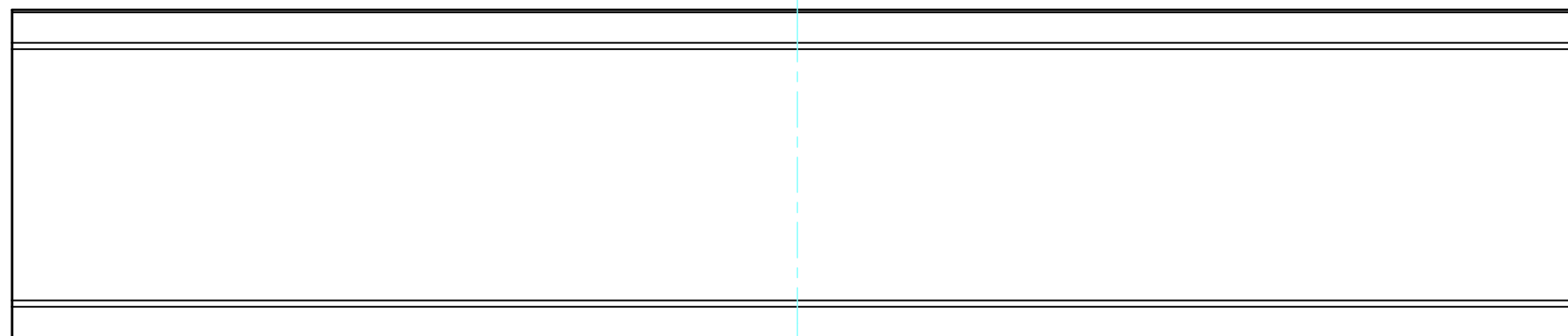
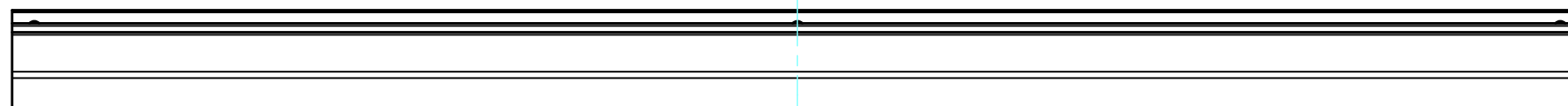
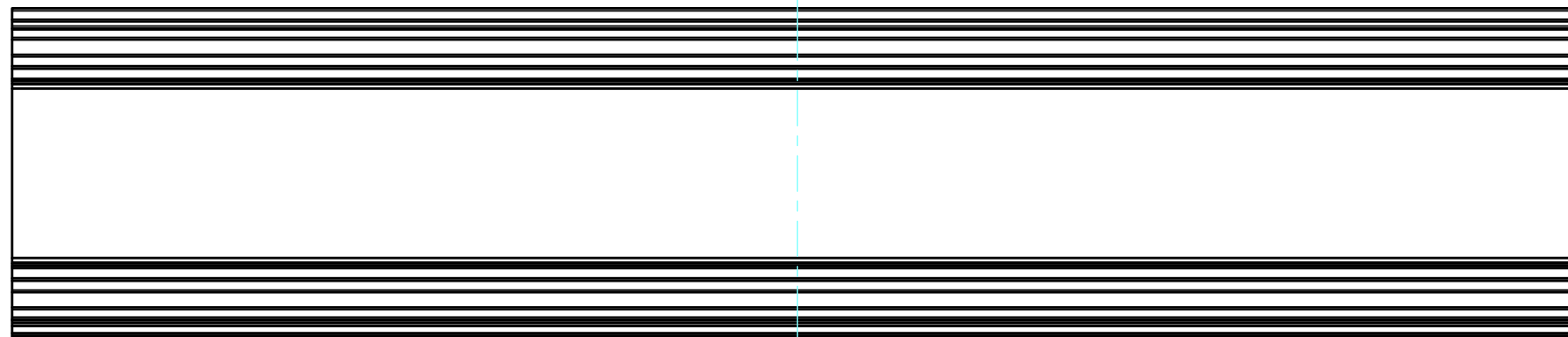

フレーム4 / Frame4

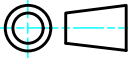
 株式会社タカチ電機工業 TAKACHI ELECTRONICS ENCLOSURE CO., LTD.		品名/Title フレーム4 Frame4	
承認/Approved	検図/Checked 大江	製図/Created 常山	型番/Product number H75.4 - D400
		作成日/Date 2017/07/27	尺度/Scale 1:1.5
			6 / 7

ハメ込みパネル / Slide panel

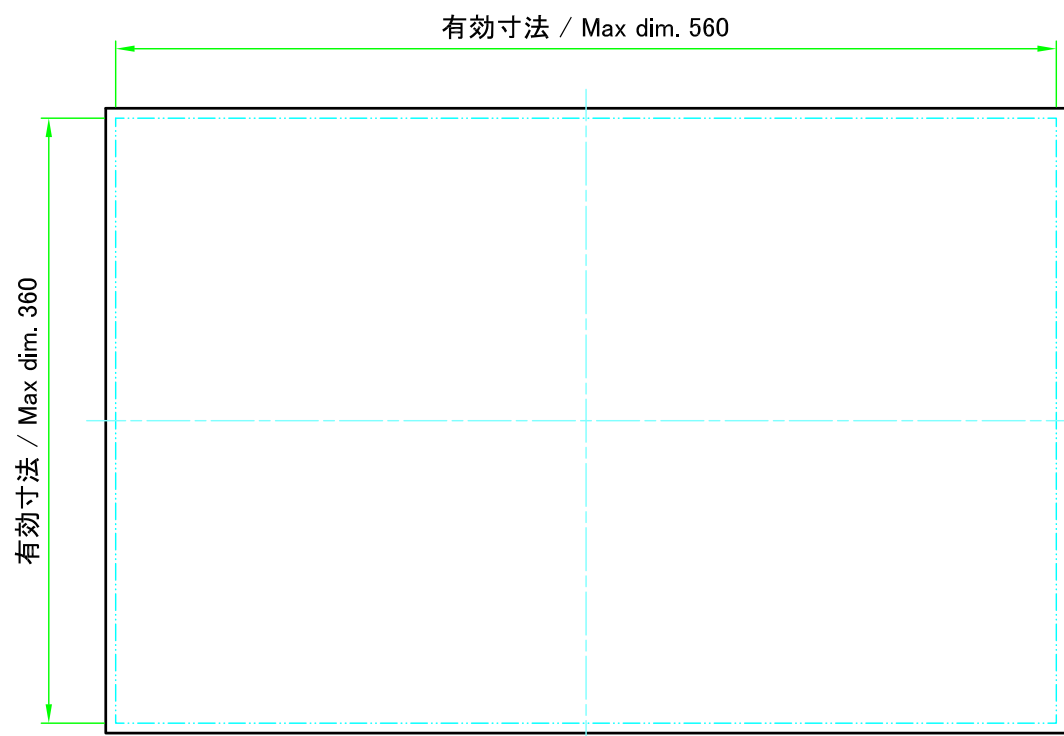

パネル表面/Panel Frontside

保護シート側
Surface protective film side



パネル裏面/Panel Backside

ねじ止めパネル / Screwed panel

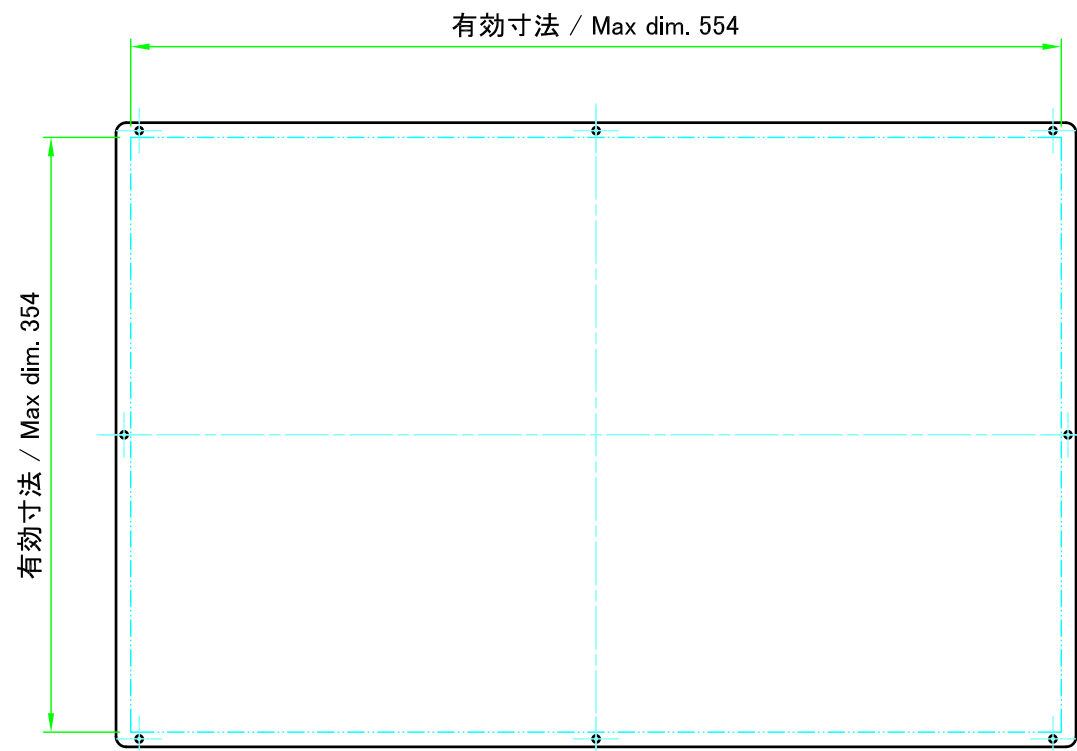

パネル表面/Panel Frontside

保護シート側
Surface protective film side

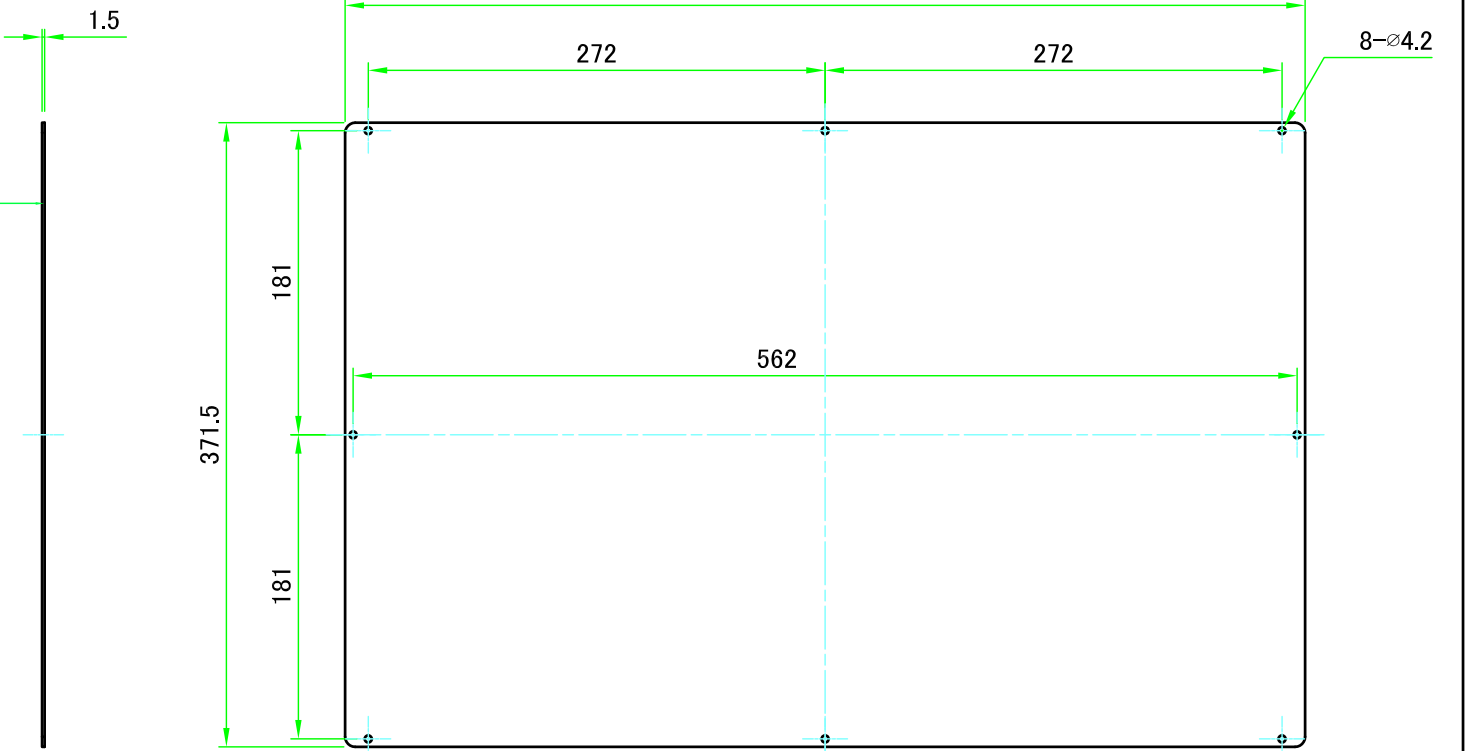

パネル裏面/Panel Backside

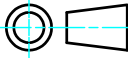
 株式会社タカチ電機工業 TAKACHI ELECTRONICS ENCLOSURE CO., LTD.			品名/Title パネル Panel	 尺度/Scale 1:4.5
承認/Approved 中根	検図/Checked 大江	製図/Created 常山	型番/Product number W600 - D400 作成日/Date 2020/07/14	