

構成内容 / Components				
No.	名称 / Part name	数量 / Pcs	材質 / Material	色・表面処理 / Color・Finish
1	パネル Panel	1	アルミ押出材 A6063S-T5 Extruded aluminium A6063S-T5	ヘアラインシルバーアルマイト Hairline brushed silver anodized
2	フレーム(AE-303) Frame(AE-303)	4	アルミ押出材 A6063S-T5 Extruded aluminium A6063S-T5	ヘアラインシルバーアルマイト Hairline brushed silver anodized
3	リアパネル Rear panel	1	アルミ押出材 A6063S-T5 Extruded aluminium A6063S-T5	ヘアラインシルバーアルマイト Hairline brushed silver anodized
4	側板 Side panel	2	アルミ板 A1050P Aluminium A1050P	ヘアラインシルバーアルマイト Hairline brushed silver anodized
5	天板 / Top cover	1	鋼板 SPCC / Steel SPCC	ブラック塗装(レザートーン) / Black painted (Leather tone)
6	底板 / Bottom cover	1	鋼板 SPCC / Steel SPCC	ブラック塗装 / Black painted
7	固定金具 Support bracket	4	鋼板 SPCC + アルミ押出材 A6063S-T5 Steel SPCC : Extruded aluminium A6063S-T5	三価クロメート + アルマイト Trivalent chromate : Anodized
8	ゴム足 / Rubber feet	4	合成ゴム / Rubber	ブラック / Black
9	取付ビス(皿M3×5) Screw(CountersunkM3-5)	16	鉄 Steel	三価クロメート Trivalent chromate
10	取付ビス(バインドW付M3×5) Screw(Binding headM3-5)	12	鉄 Steel	三価黒クロメート Black trivalent chromate
11	取付ビス(ナベM3×10) Screw(Pan headM3-10)	4	鉄 Steel	三価クロメート Trivalent chromate
12	取手 / Handle	2	アルミ丸棒 A5056 / Aluminium A5056	研磨アルマイト / Silver Anodized
13	座金 / Handle washer	2	真ちゆう / Brass	スズコバルトメッキ / Nickel-cobalt plated
14	取付ビス(ナベSW付M4×10) Screw(Pan headM4-10)	4	鉄 Steel	三価クロメート Trivalent chromate

<b>株式会社タカチ電機工業</b> TAKACHI ELECTRONICS ENCLOSURE CO., LTD.			品名/Title <b>取手付JISラックケース</b> JIS RACK MOUNT ENCLOSURE with HANDLE	尺度/Scale 1 : 5.5
承認/Approved	検図/Checked	製図/Created	型番/Product number <b>JRH299-20S</b>	
中根	野村	岡本	作成日/Date 2022/11/17	1 / 7

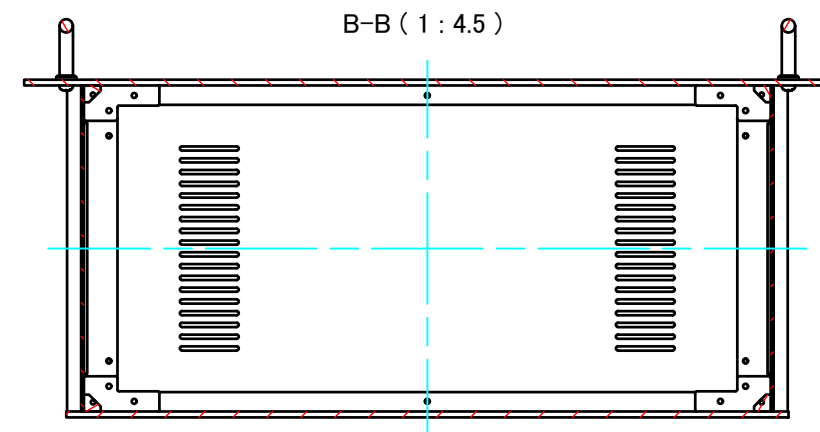
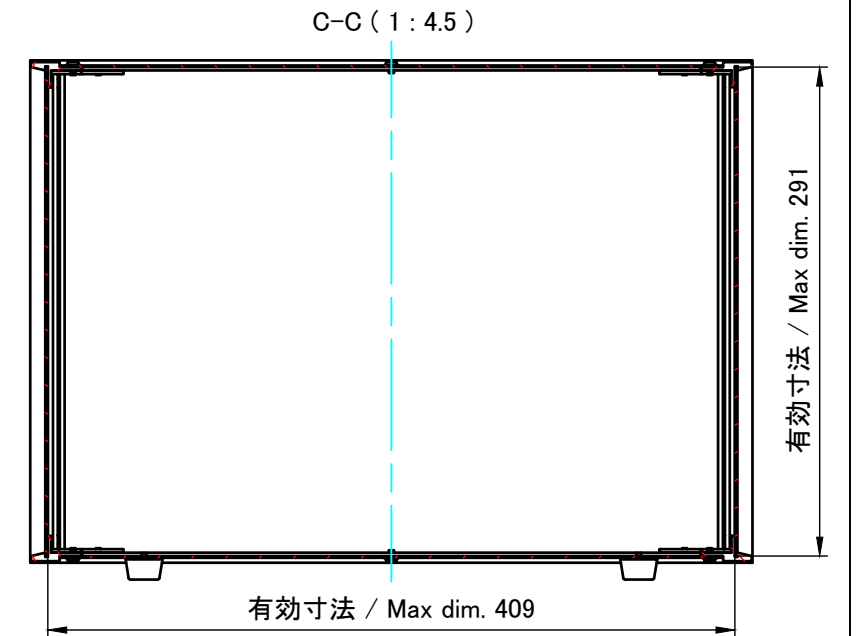
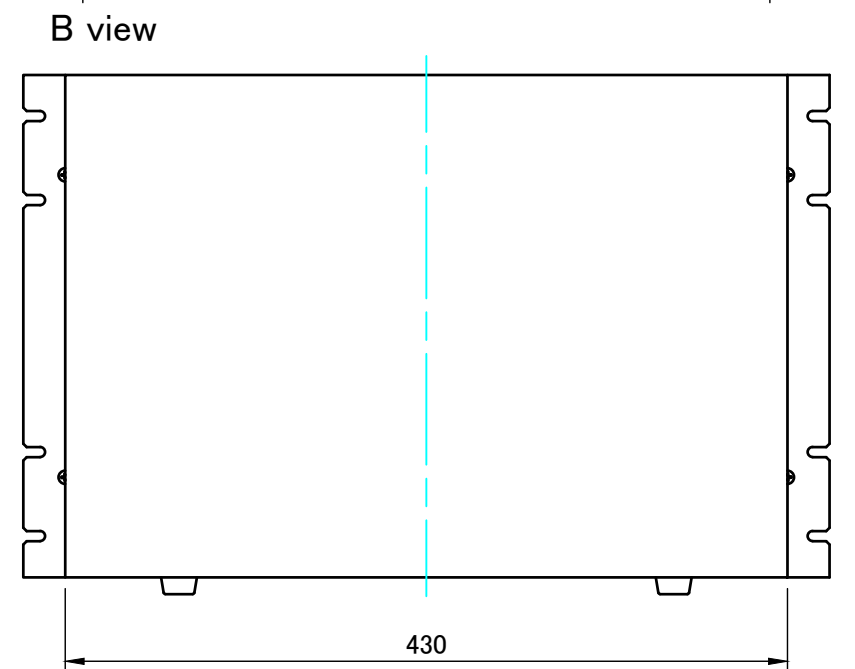
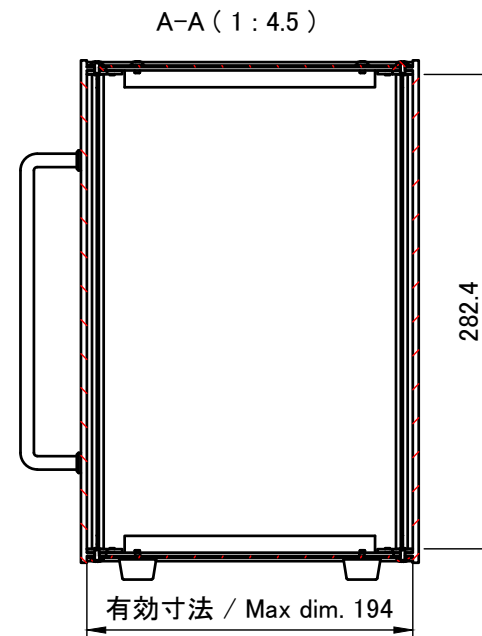
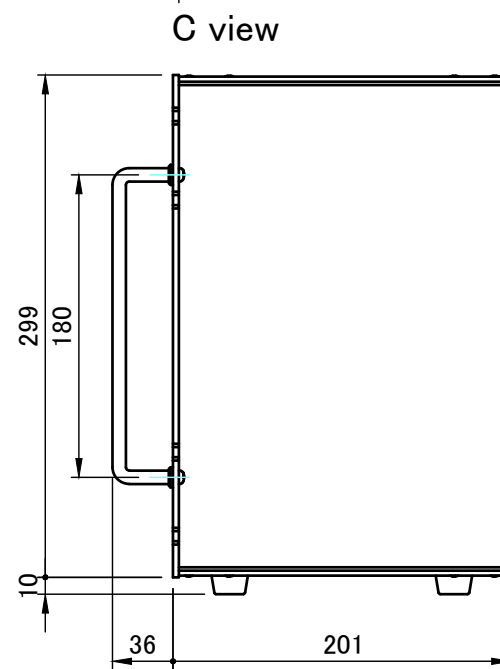
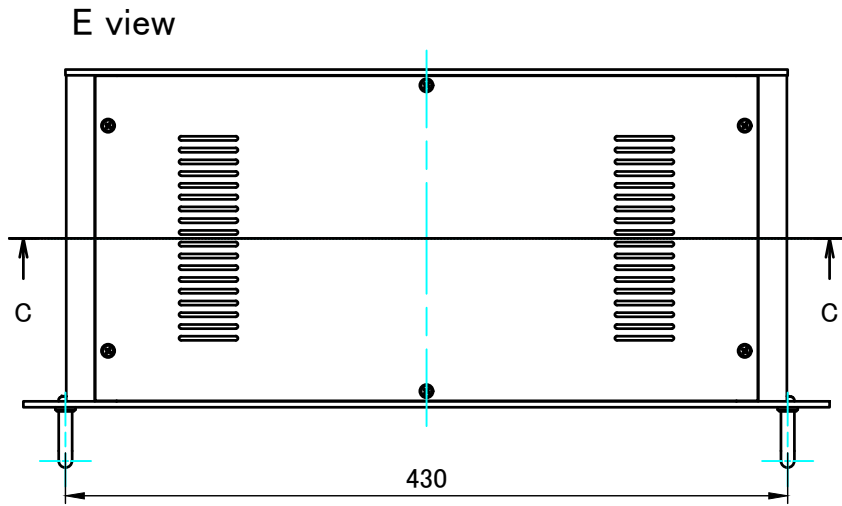
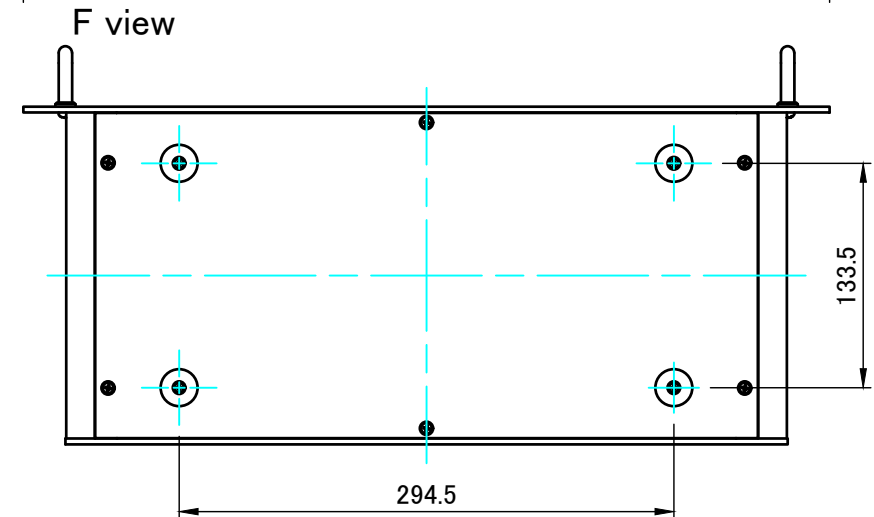
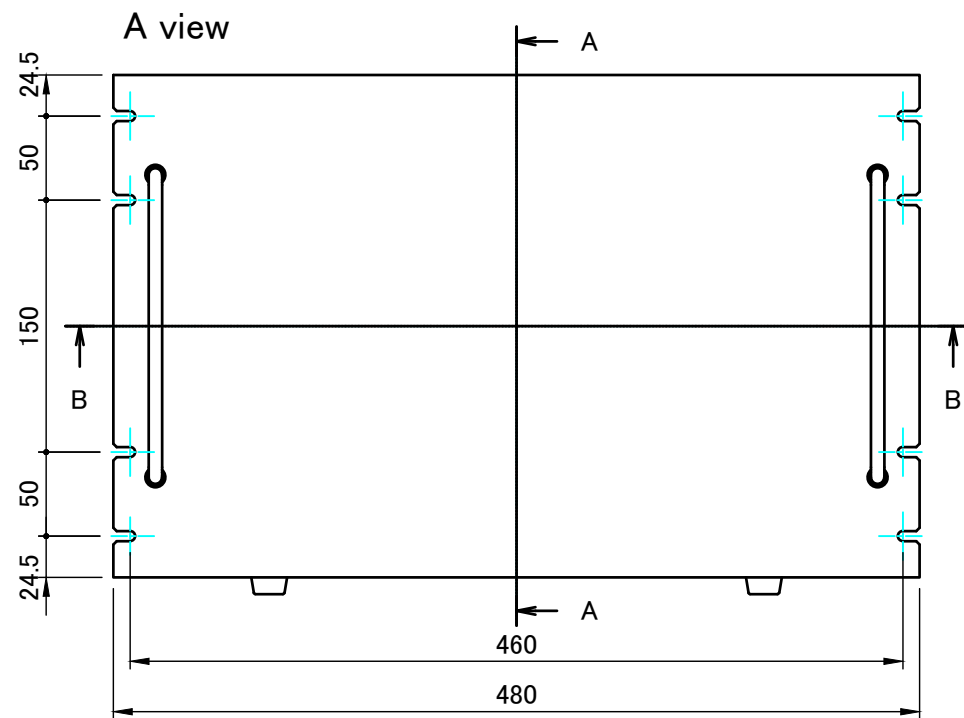
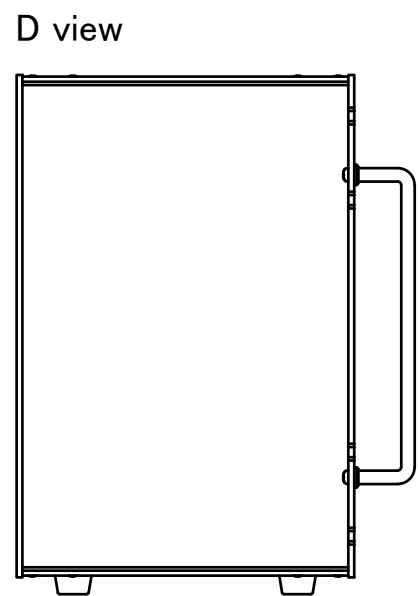

<b>株式会社タカチ電機工業</b> TAKACHI ELECTRONICS ENCLOSURE CO., LTD.			品名/Title <b>取手付JISラックケース</b> JIS RACK MOUNT ENCLOSURE with HANDLE	尺度/Scale 1 : 4.5
承認/Approved	検図/Checked	製図/Created	型番/Product number <b>JRH299-20S</b>	
中根	野村	岡本	作成日/Date 2023/03/29	2 / 7

パネル / Panel

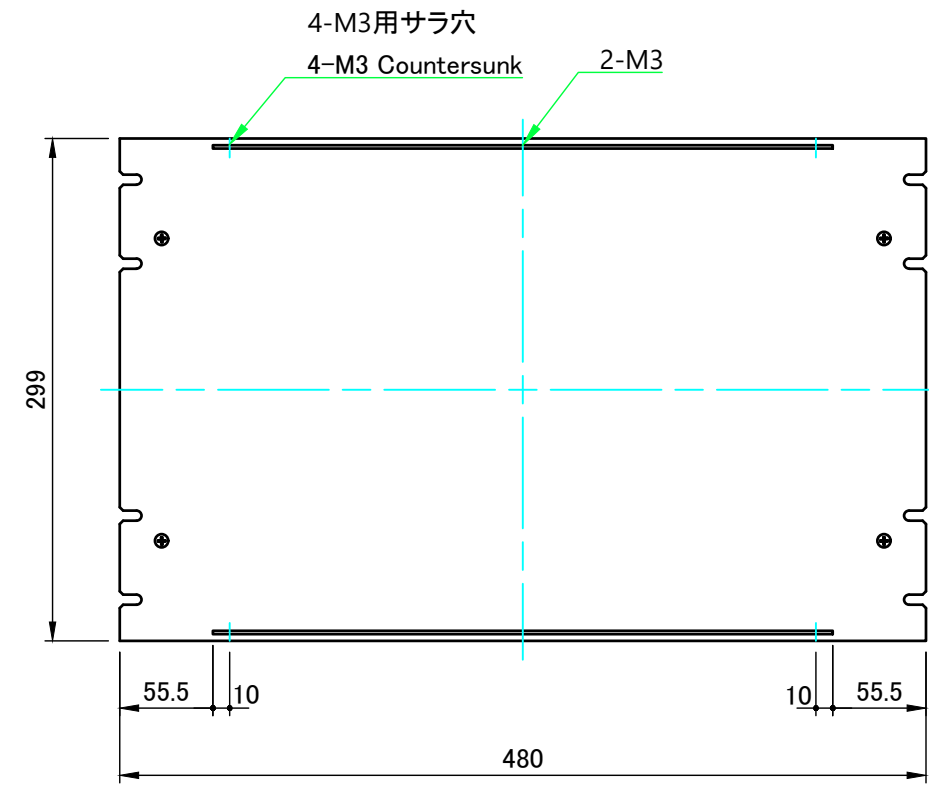
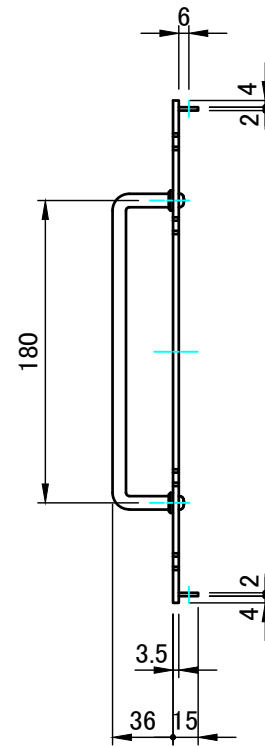
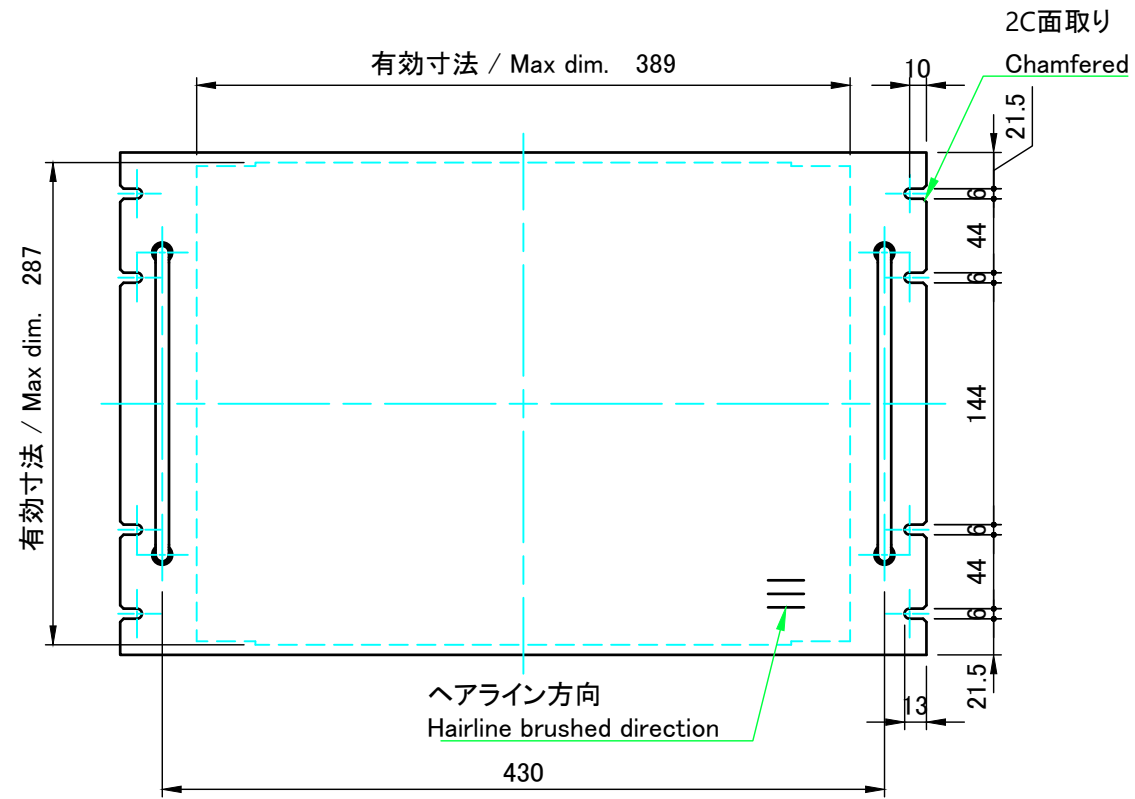

表面 / Front side

裏面 / Back side

リアパネル / Rear Panel

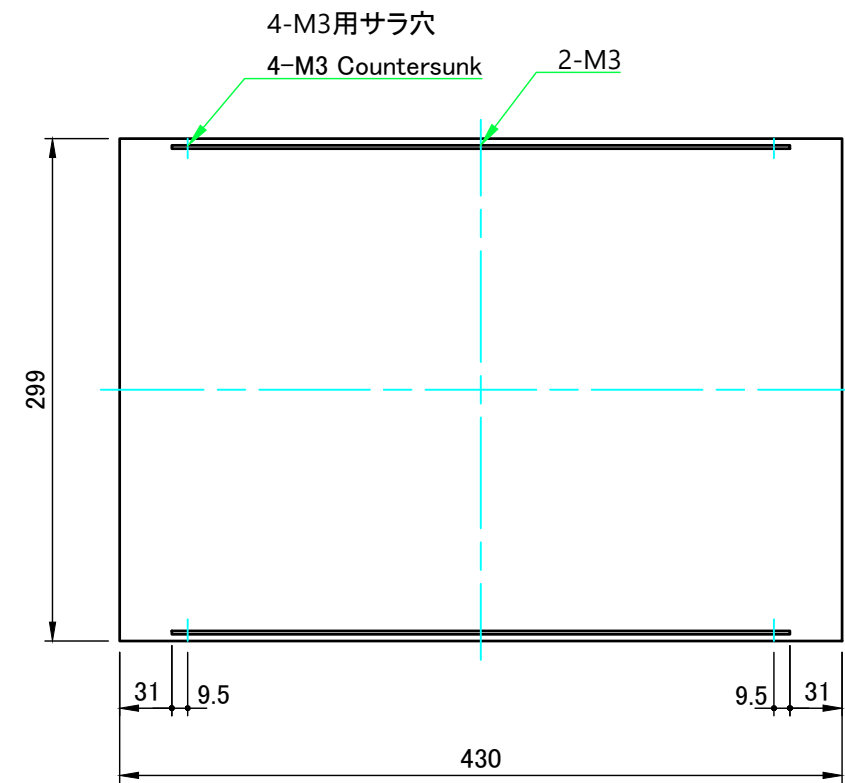
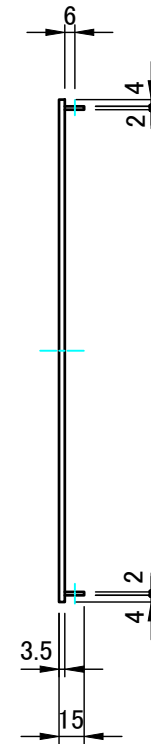
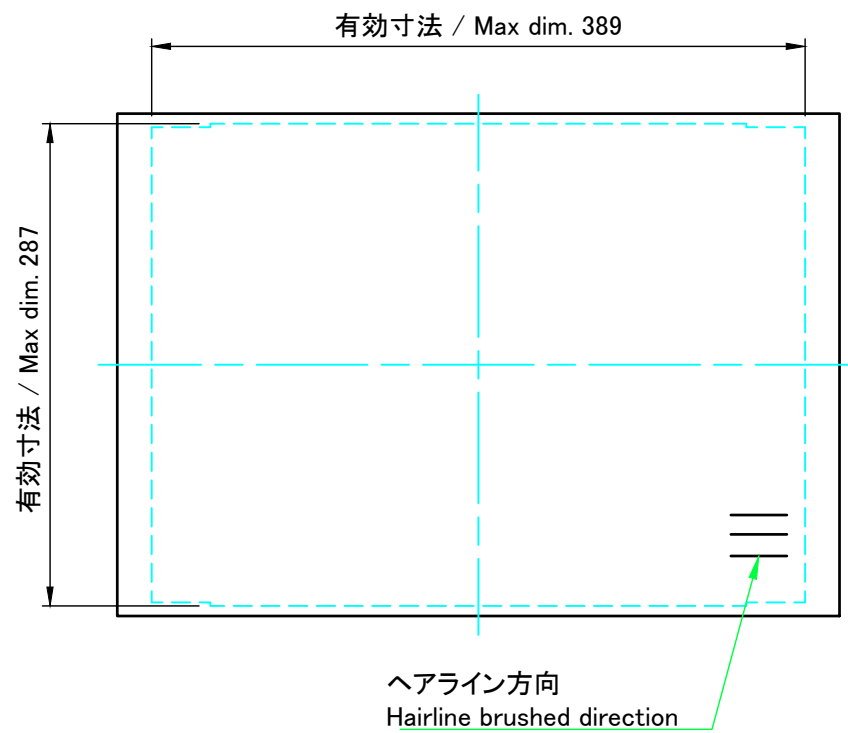

表面 / Front side

裏面 / Back side

<b>株式会社タカチ電機工業</b> TAKACHI ELECTRONICS ENCLOSURE CO., LTD.			品名/Title パネル, リアパネル Panel, Rear panel	尺度/Scale 1 : 4.5
承認/Approved	検図/Checked	製図/Created	型番/Product number H299-W480, H299-W430	
中根	野村	岡本	作成日/Date 2021/01/21	3 / 7

C 側板 / C Side panel

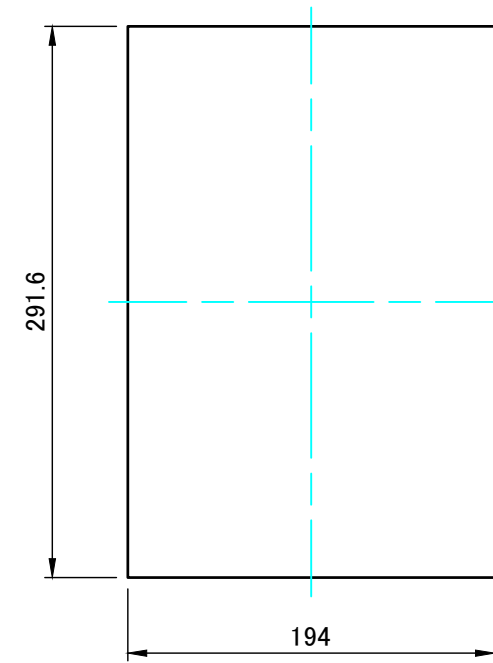
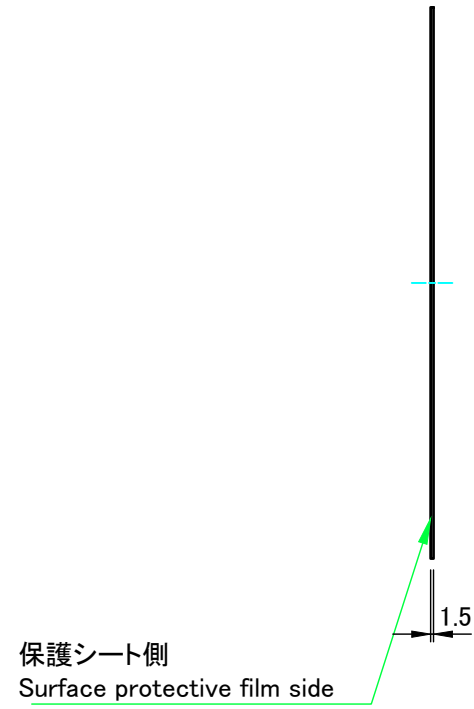
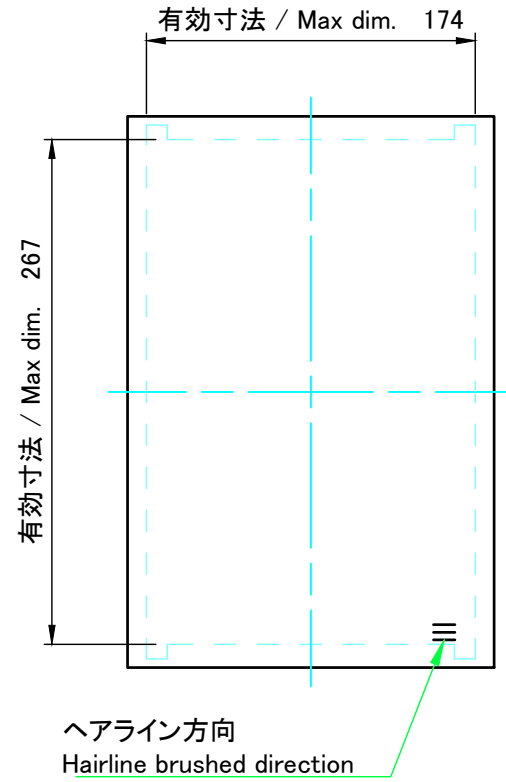

表面 / Front side

裏面 / Back side

D 側板 / D Side panel

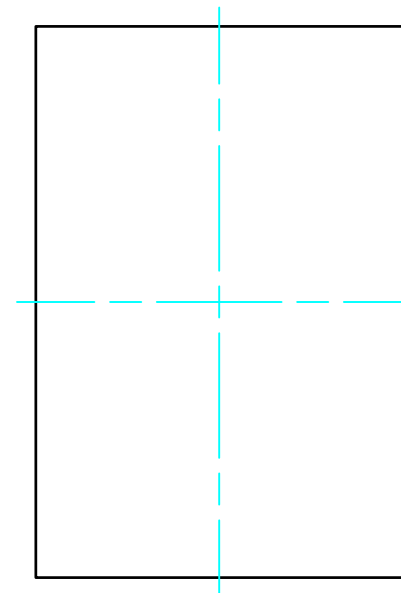
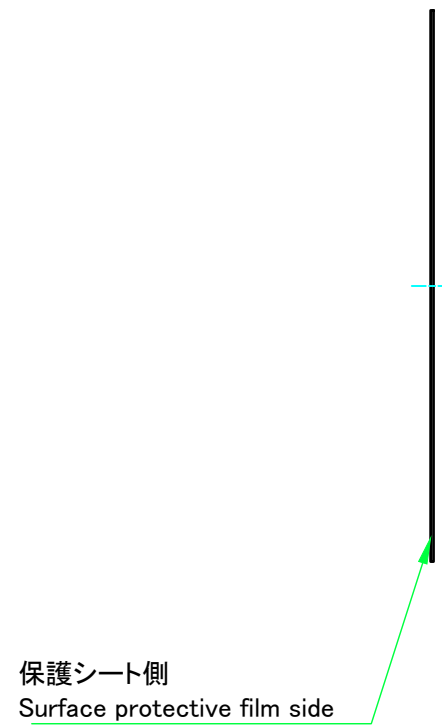
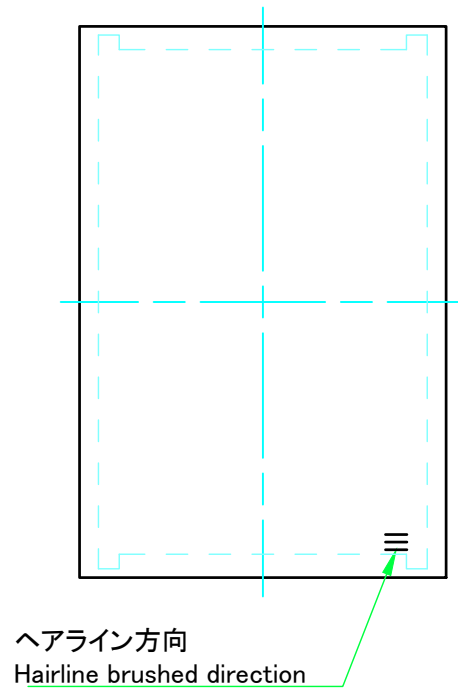



表面 / Front side

裏面 / Back side

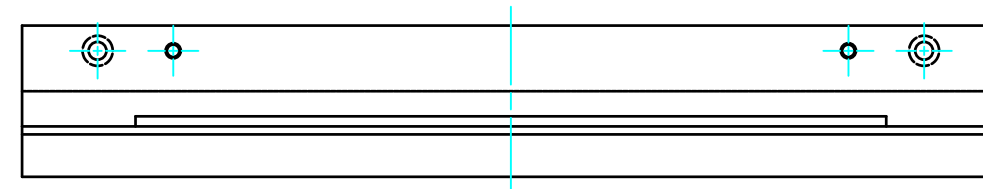
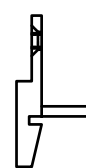
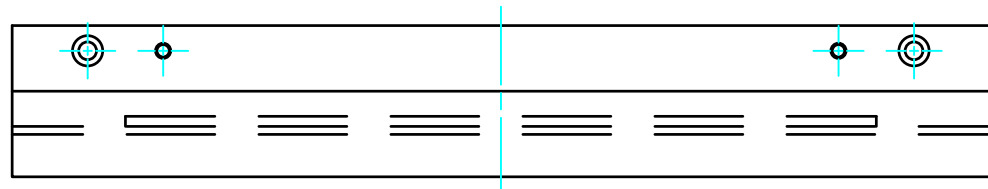
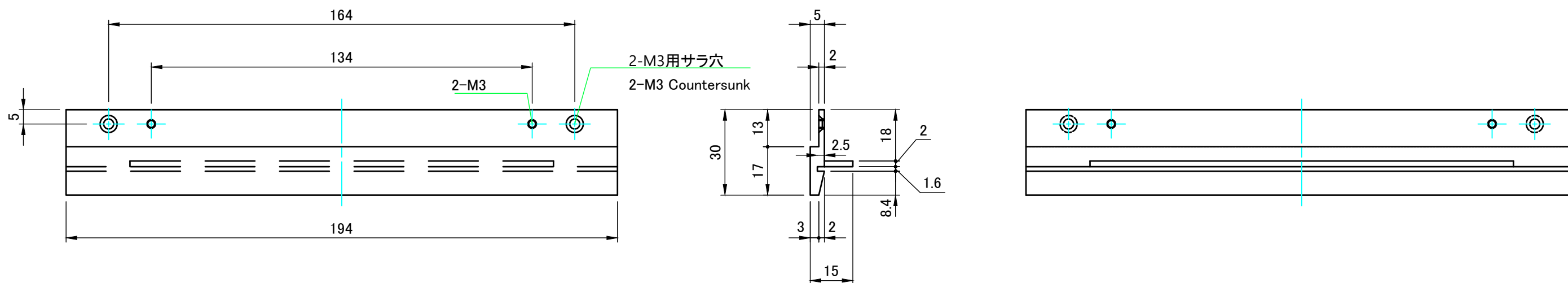
株式会社タカチ電機工業 TAKACHI ELECTRONICS ENCLOSURE CO., LTD.			品名/Title 側板 Side panel	尺度/Scale 1 : 4
承認/Approved 中根	検図/Checked 野村	製図/Created 岡本	型番/Product number H299×D200	
			作成日/Date 2023/03/29	4 / 7



 <b>株式会社タカチ電機工業</b> <small>TAKACHI ELECTRONICS ENCLOSURE CO., LTD.</small>			品名/Title フレーム (AE-303) Frame (AE-303)	 尺度/Scale 1 : 1.5
承認/Approved 中根	検図/Checked 野村	製図/Created 岡本	型番/Product number AE-303-D200 作成日/Date 2021/01/21	

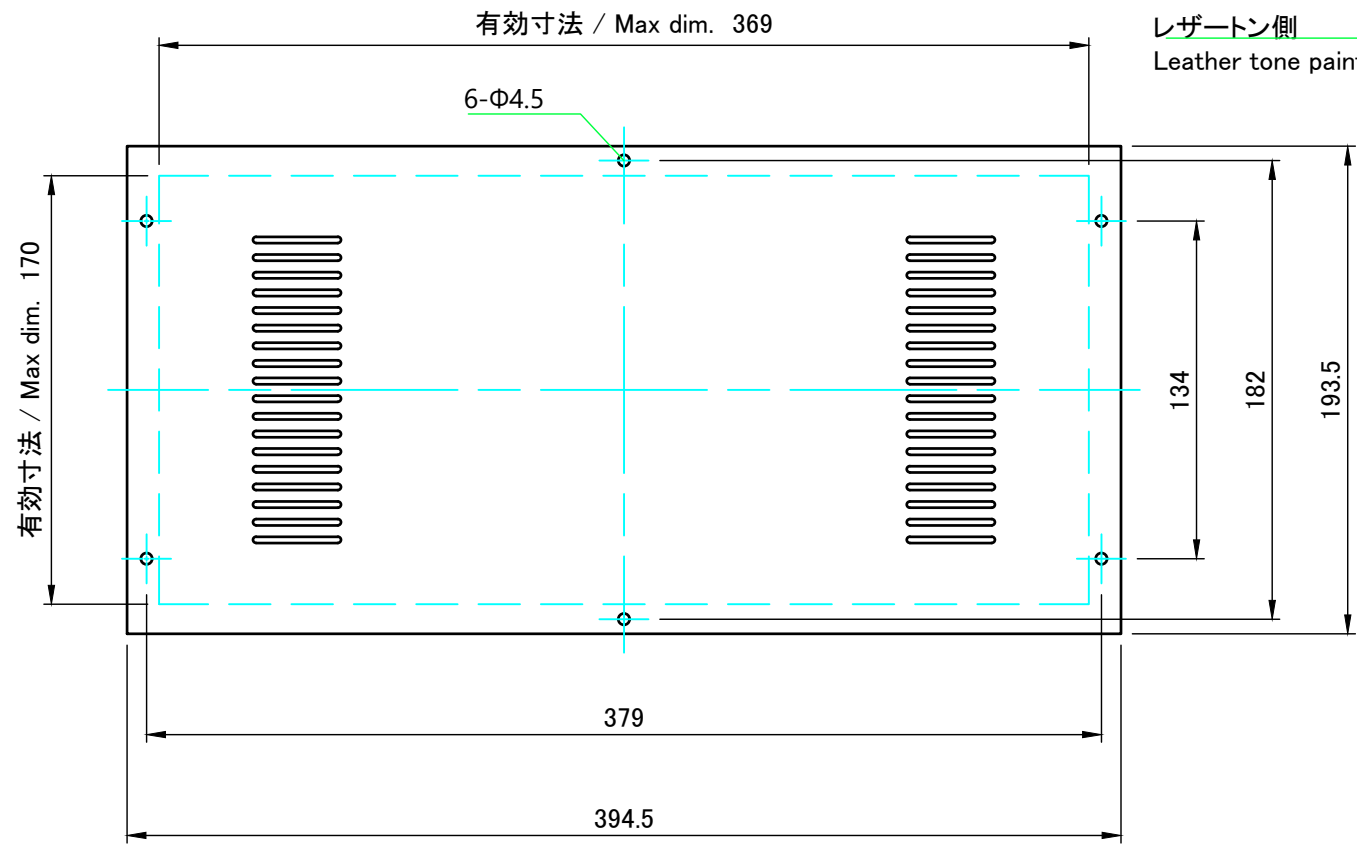

表面 / Front side

レザー-ton側  
Leather tone paint side

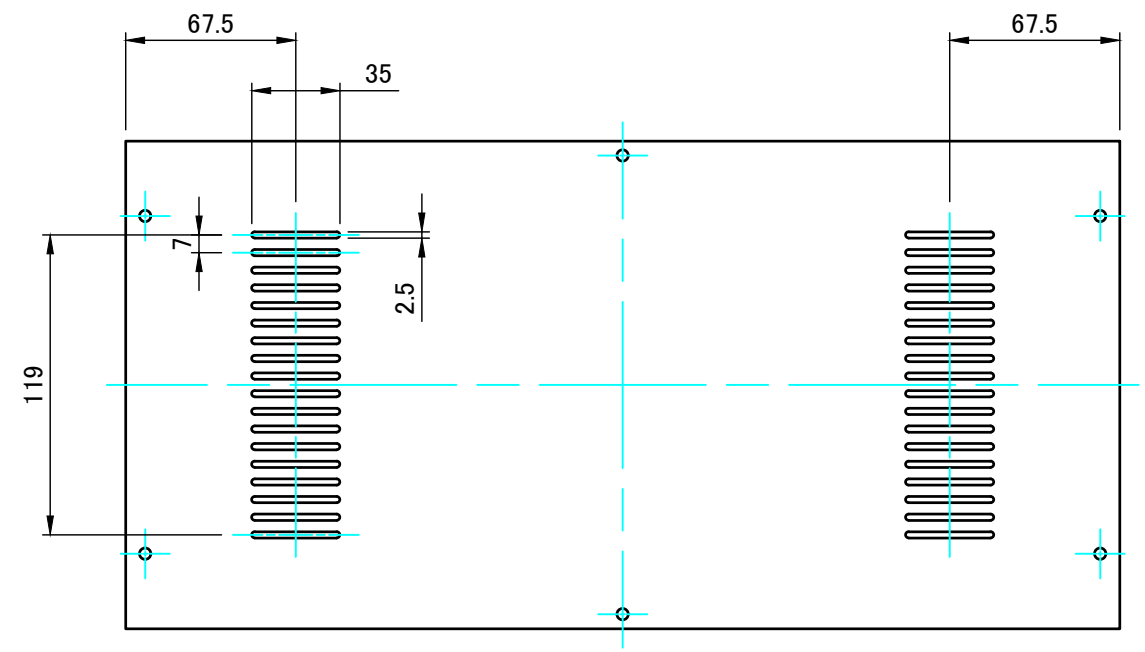

裏面 / Back side

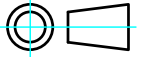
 <b>株式会社タカチ電機工業</b> <small>TAKACHI ELECTRONICS ENCLOSURE CO., LTD.</small>			品名/Title <b>天板</b> Top cover	 尺度/Scale 1 : 3
承認/Approved	検図/Checked	製図/Created	型番/Product number <b>W430-D200</b>	
中根	野村	岡本	作成日/Date 2021/01/21	6 / 7

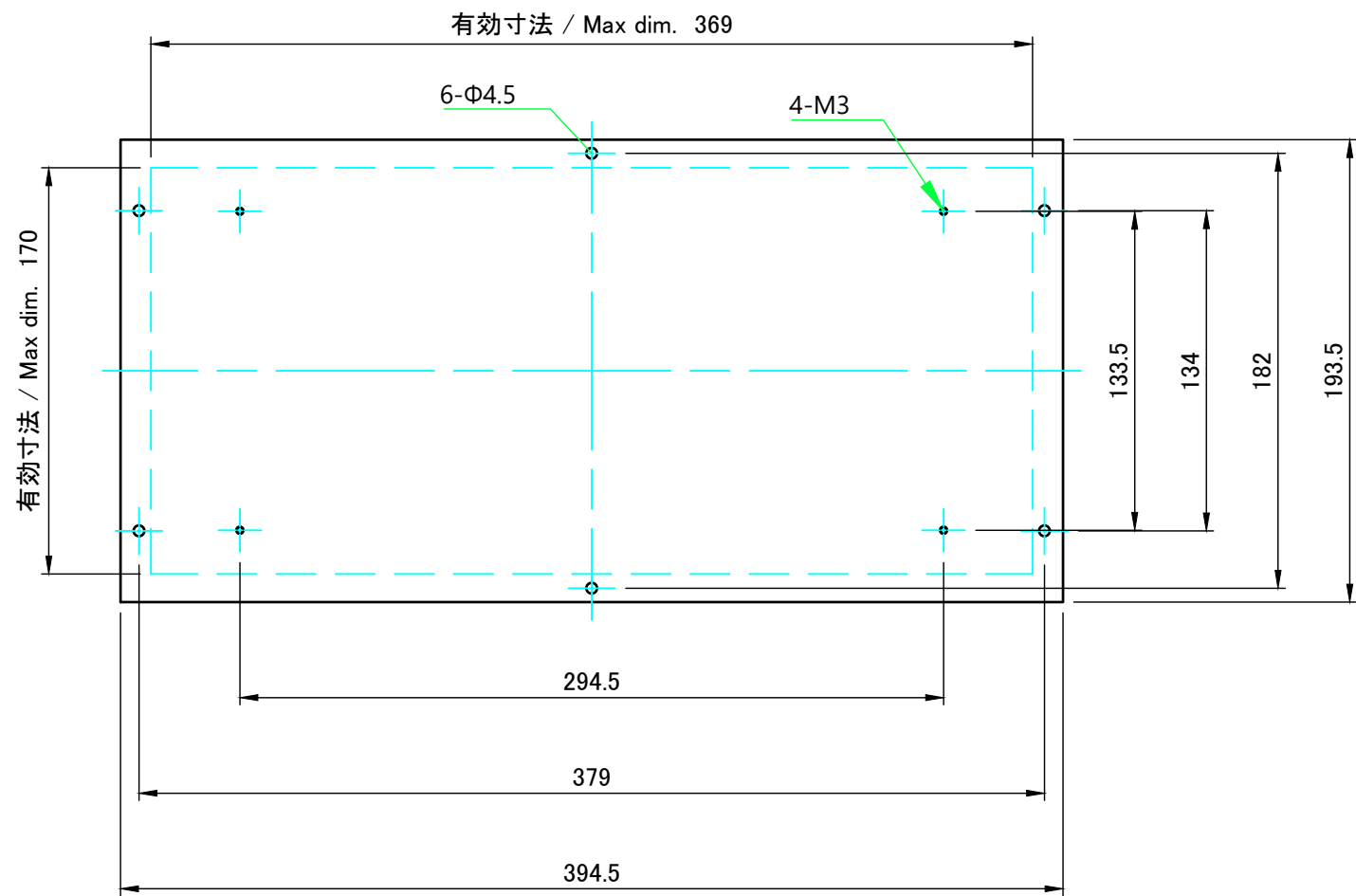

表面 / Front side

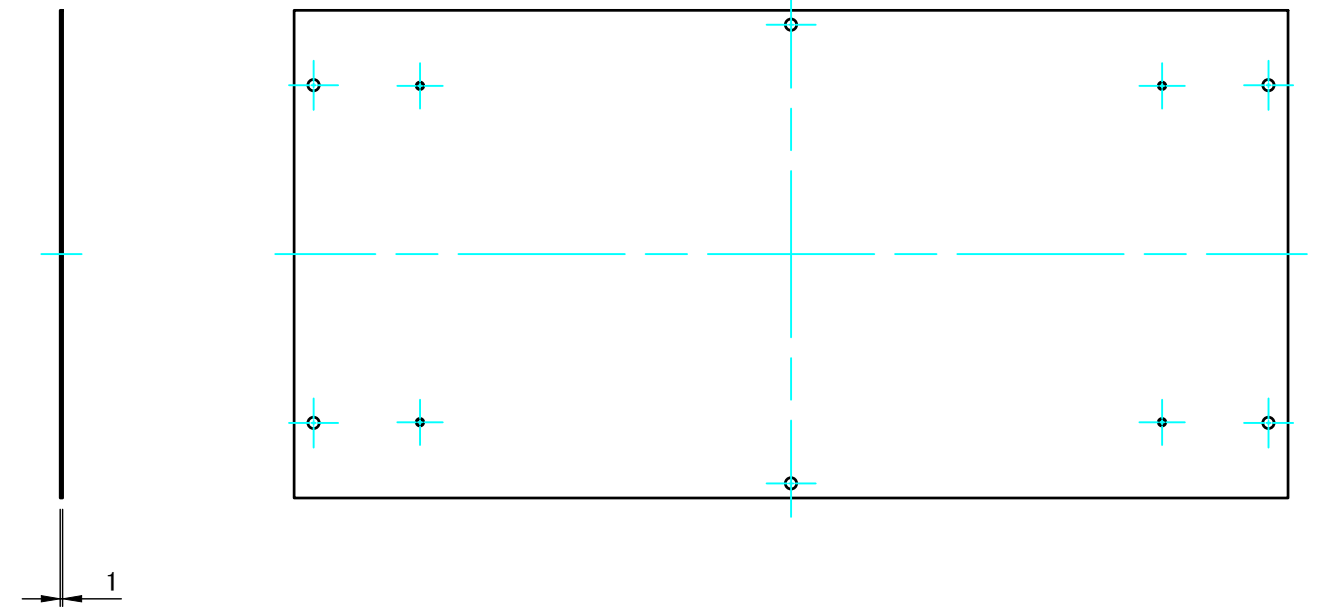

裏面 / Back side

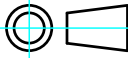
 株式会社タカチ電機工業 TAKACHI ELECTRONICS ENCLOSURE CO., LTD.			品名/Title 底板 Bottom cover	
承認/Approved	検図/Checked	製図/Created	型番/Product number W430-D200	
中根	野村	岡本	作成日/Date 2021/01/21	7 / 7