

外視

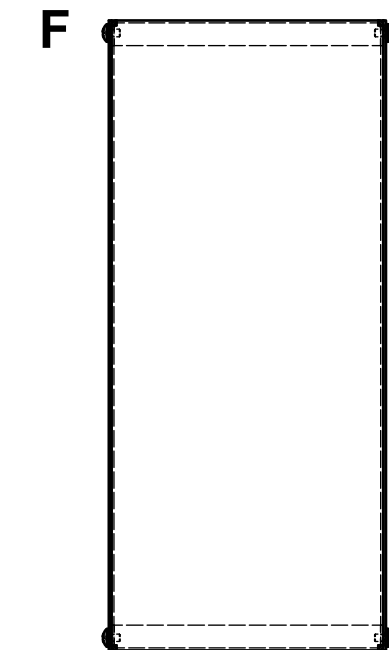

構成内容				
No.	名称	数量	材質	色・表面処理
1	カバー	1	アルミ板 A1100P t1.0	表面 ｸﾞﾘｯｸｼﾙﾊﾞｰ塗装, 裏面 導通処理
2	シャーシ	1	アルミ板 A1100P t1.0	表面 ｸﾞﾘｯｸｼﾙﾊﾞｰ塗装, 裏面 導通処理
3	取付ビス(トラスM3 x 5)	4	真ちゆう	ニッケルメッキ
4	ワッシャー(M3用)	4	真ちゆう	ニッケルメッキ

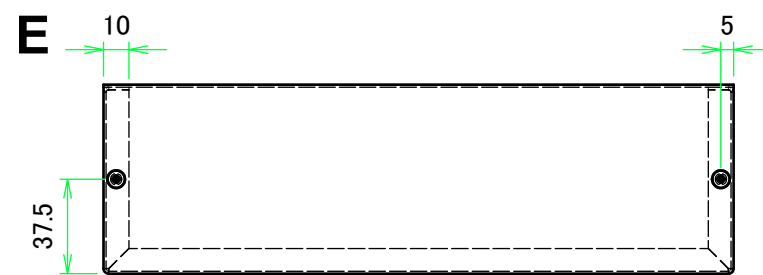
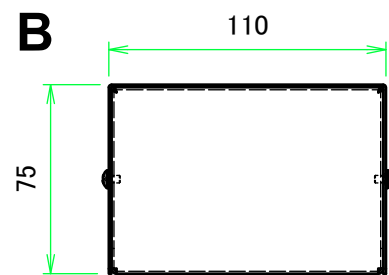
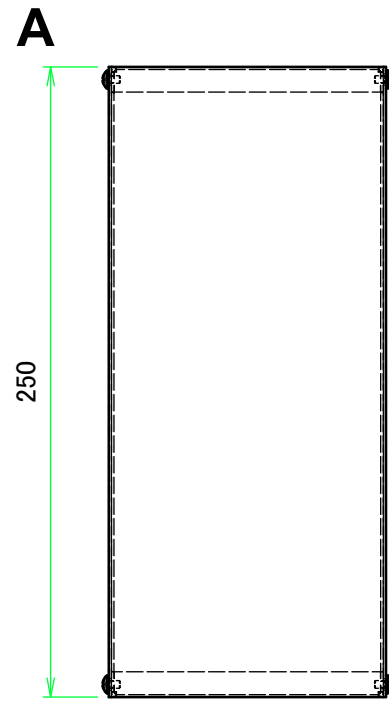
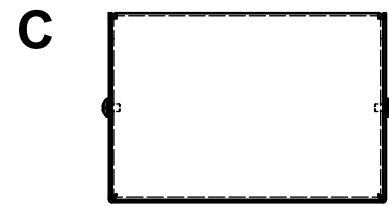
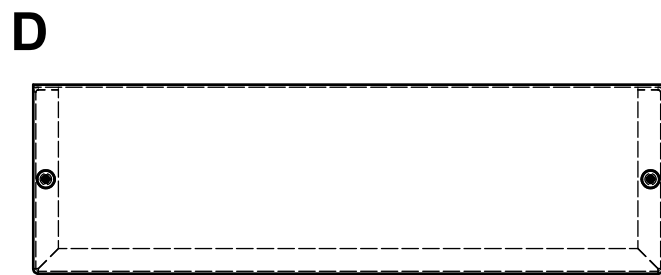
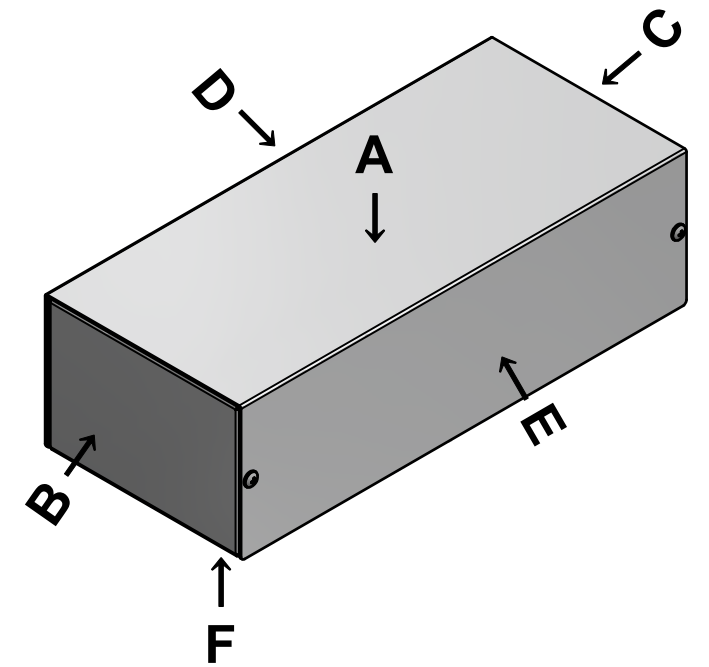
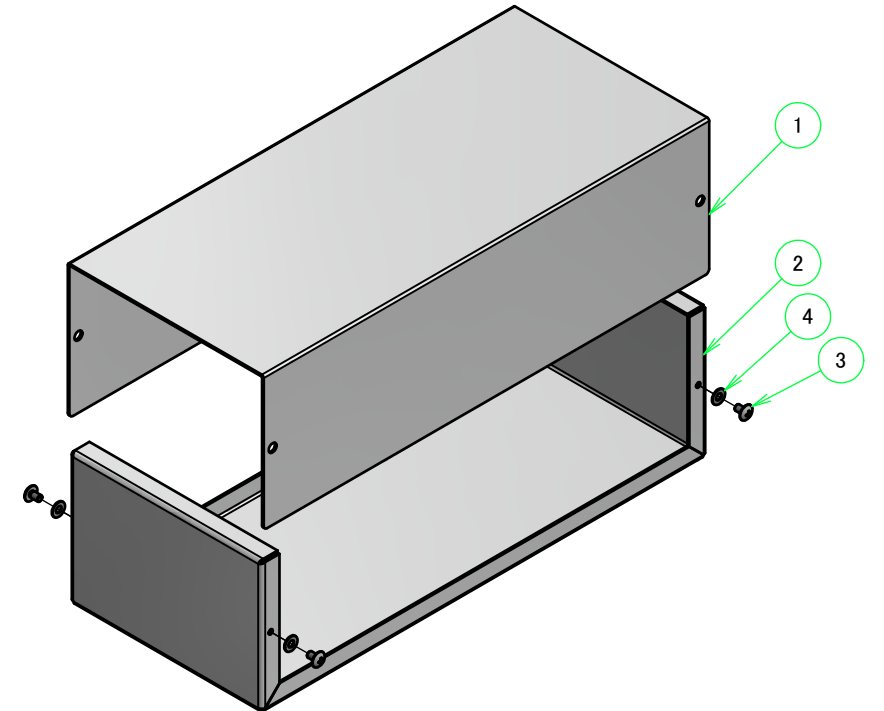

株式会社タカチ電機工業			品名 アルミケース	尺度 1:3
承認 中根	検図 王	製図 横田	型番 MB11-8-25 作成日 2018/12/19	

カバー

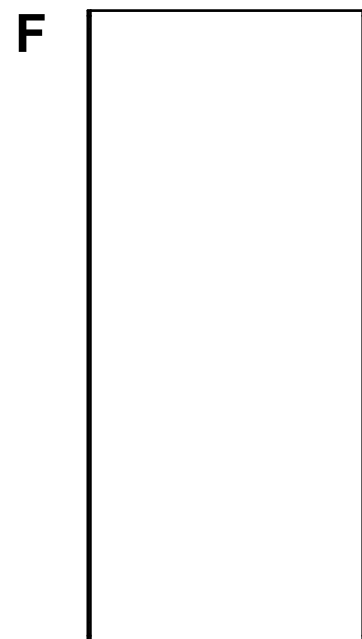
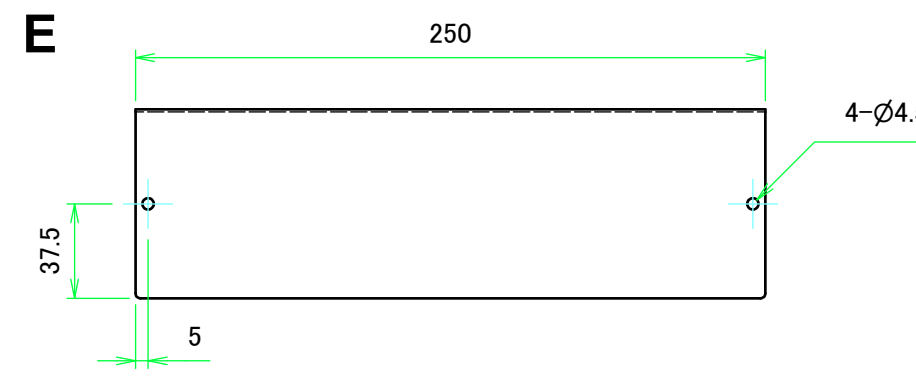
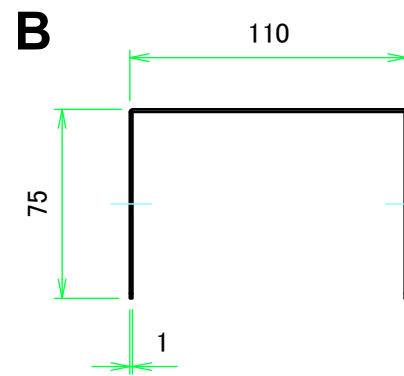
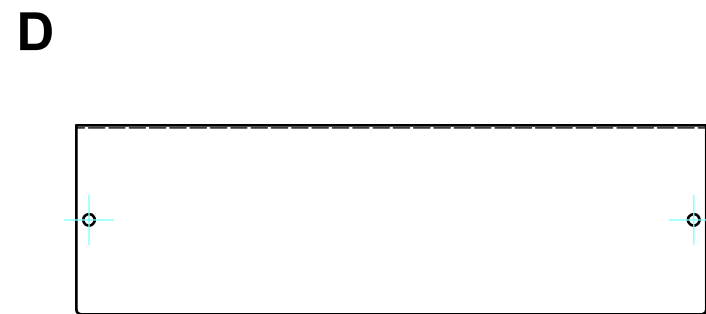
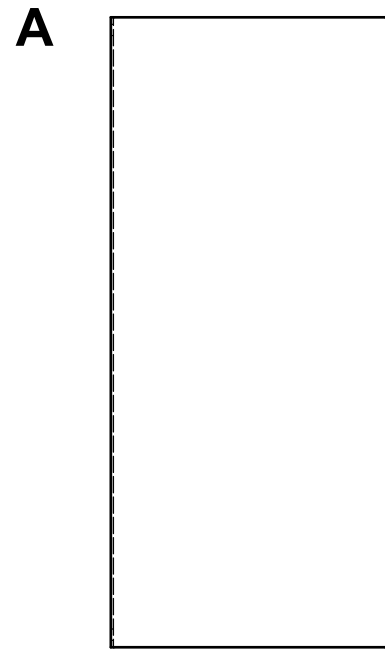
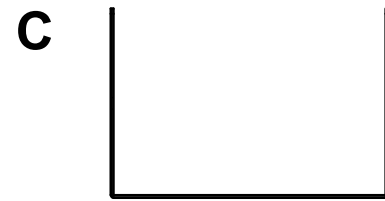

 株式会社タカチ電機工業			品名 アルミケース	
承認	検図	製図	型番 MB11-8-25	
中根	王	横田	作成日 2018/12/19	2 / 3

シャーシ

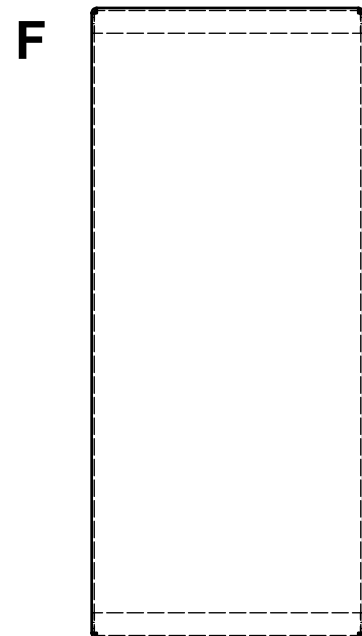
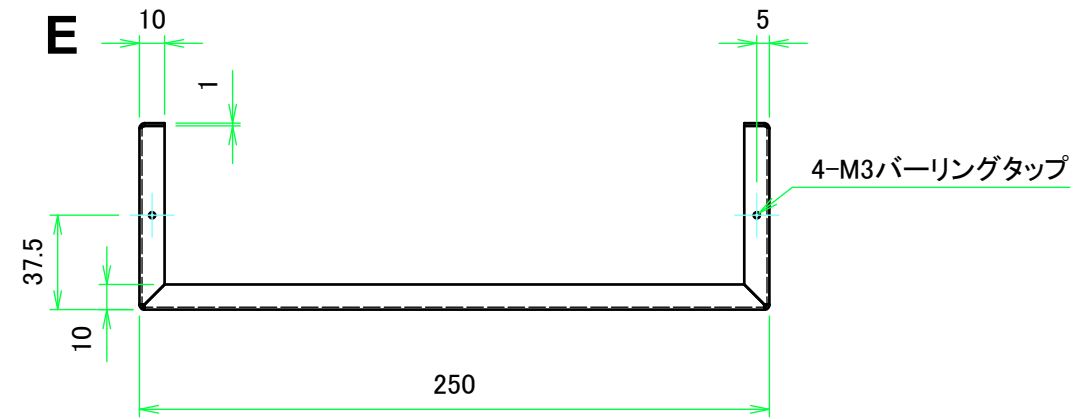
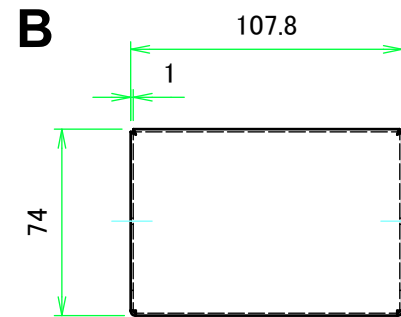
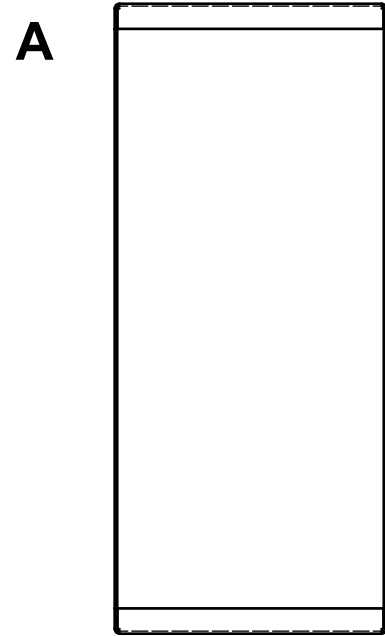
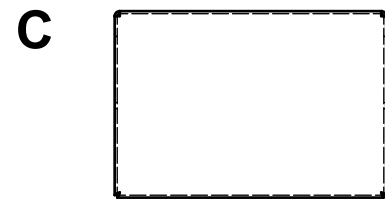

株式会社タカチ電機工業			品名 アルミケース	
承認 中根	検図 王	製図 横田	型番 MB11-8-25	
			作成日 2018/12/19	3 / 3