

外視

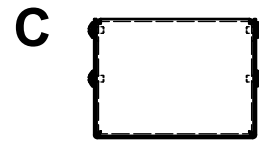

A

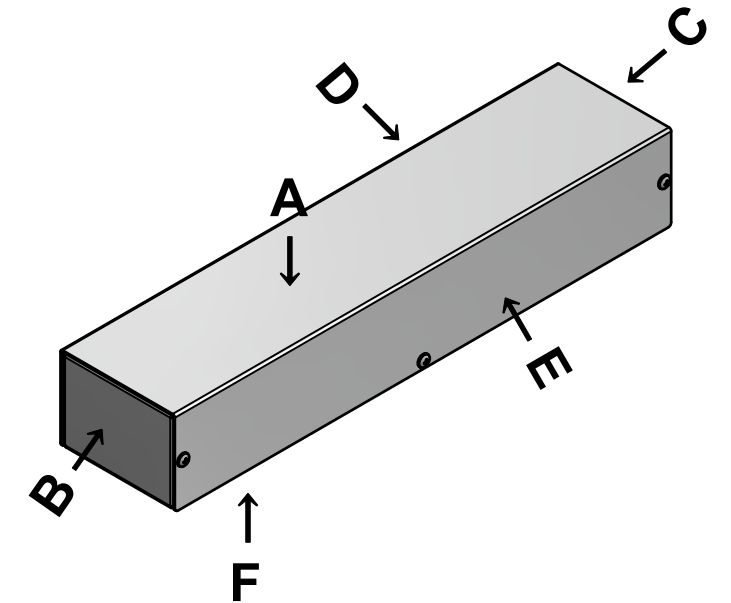
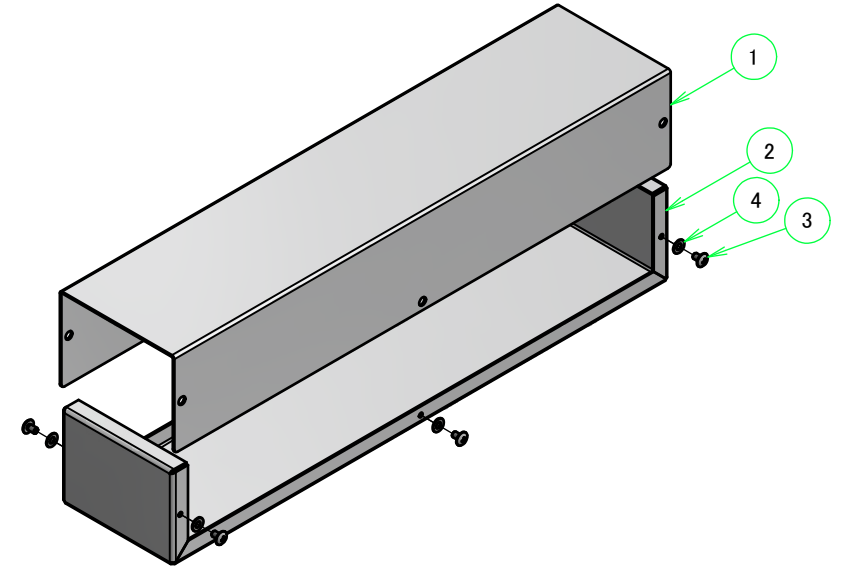
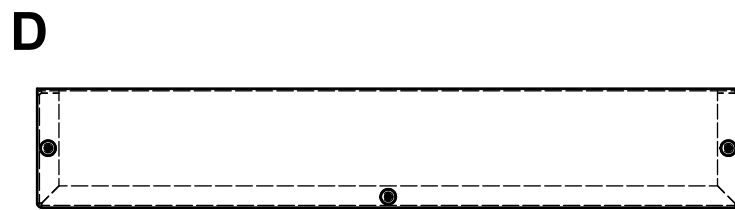
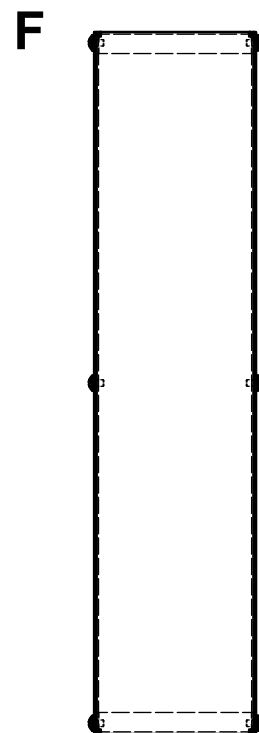
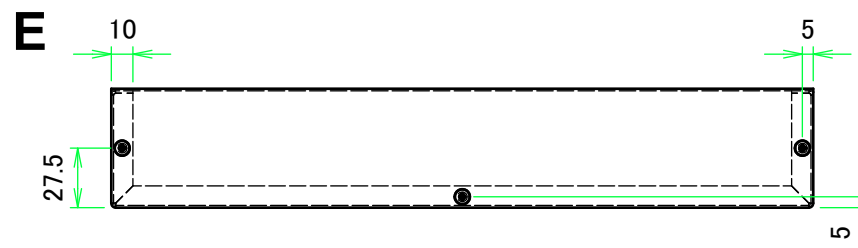
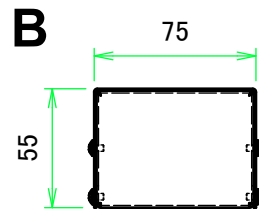
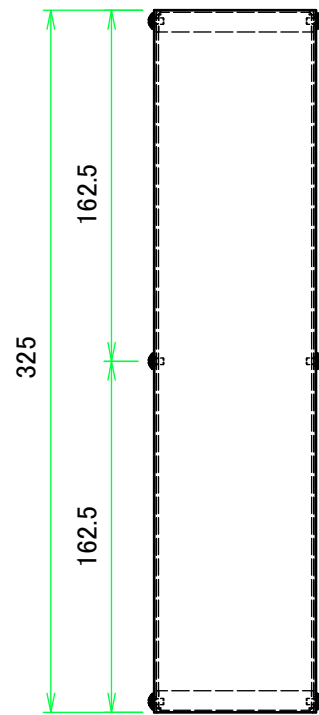

構成内容				
No.	名称	数量	材質	色・表面処理
1	カバー	1	アルミ板 A1100P t1.0	表面 メトリックシルバー塗装, 裏面 導通処理
2	シヤーシ	1	アルミ板 A1100P t1.0	表面 メトリックシルバー塗装, 裏面 導通処理
3	取付ビス(トラスM3 x 5)	6	真ちゆう	ニッケルメッキ
4	ワッシャー(M3用)	6	真ちゆう	ニッケルメッキ

株式会社タカチ電機工業			品名 アルミケース	尺度 1:3
承認 中根	検図 王	製図 横田	型番 MB8-6-33	
			作成日 2018/12/17	1 / 3

カバー

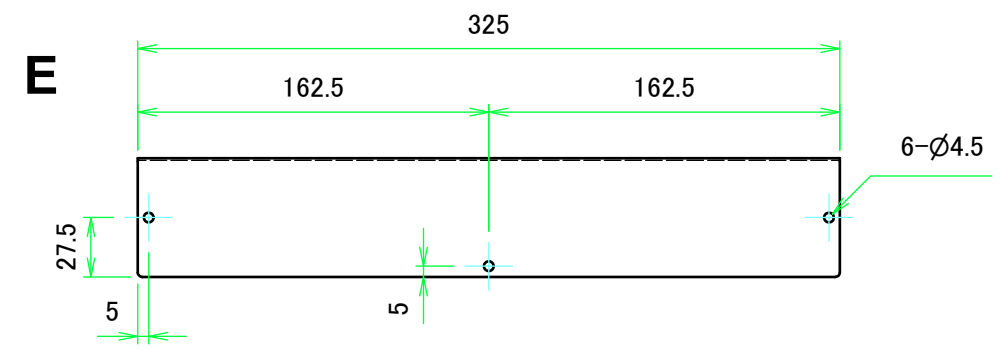
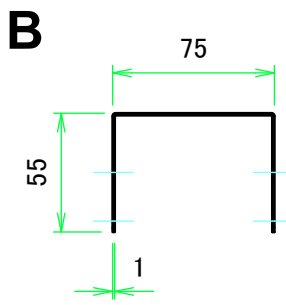
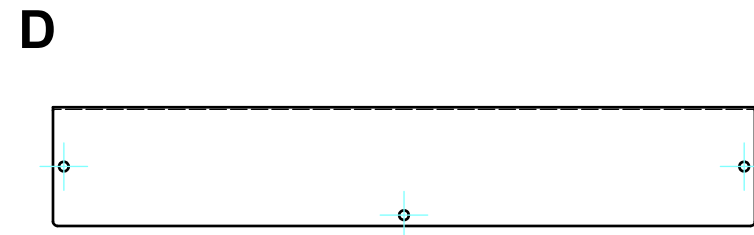
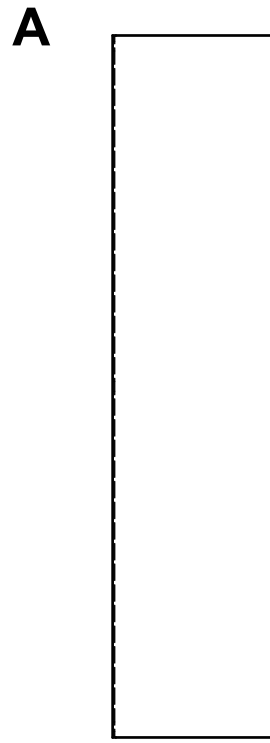
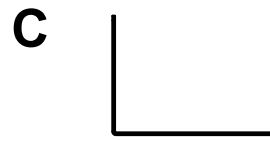

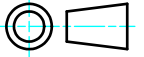
 株式会社タカチ電機工業			品名 アルミケース		
承認	検図	製図	型番 MB8-6-33		尺度 1:3.5
中根	王	横田	作成日 2018/12/17		2 / 3

シャーシ

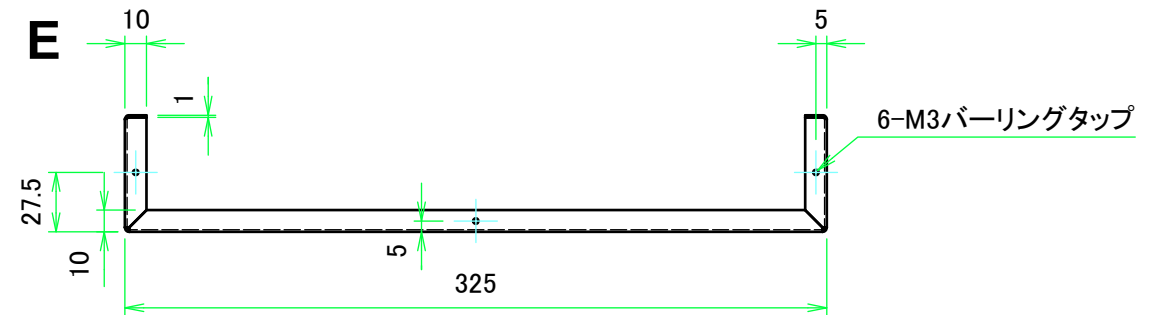
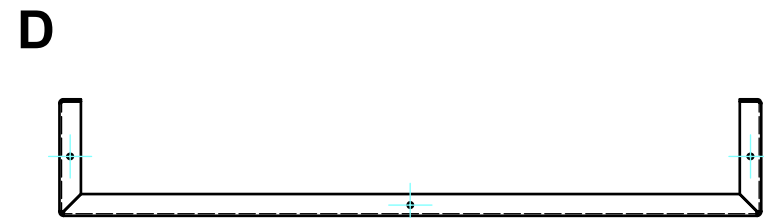
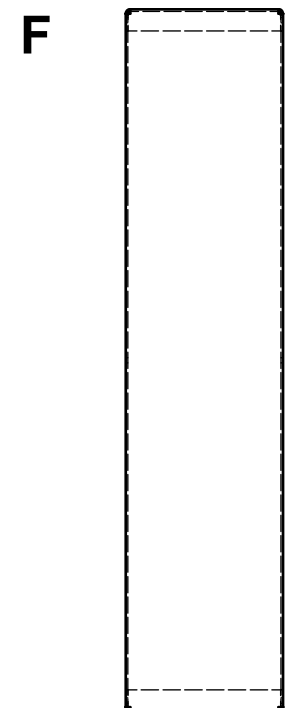
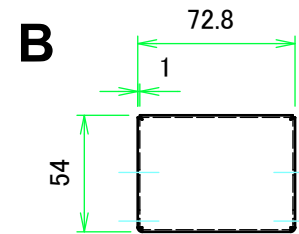
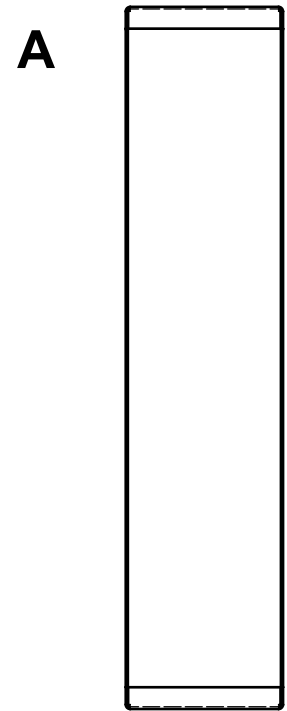
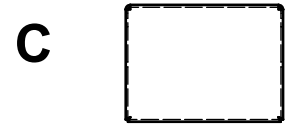

株式会社タカチ電機工業			品名 アルミケース	
承認	検図	製図	型番 MB8-6-33	
中根	王	横田	作成日 2018/12/17	3 / 3