

構成内容 / Components				
No.	名称 / Part name	数量 / Pcs	材質 / Material	色・表面処理 / Color・Finish
1	上下カバー Top and Bottom cover	各1 1 each	アクリル板 t3.0 Acrylic t3.0	透明 Transparent
2	Wパネル W Panel	2	アクリル板 t3.0 Acrylic t3.0	透明 Transparent
3	Dパネル D Panel	2	アクリル板 t3.0 Acrylic t3.0	透明 Transparent
4	支柱 Extruded Pillar	4	アルミ押出材 A6063S-T5 Extruded aluminium A6063S-T5	シルバーアルマイト Silver・Anodized
5	取付用ローレットビス(M4 x 8) Knurled Thumb Screw(M4 - 8)	8	真ちゅう Brass	ニッケルメッキ Nickel plated
6	ゴム足 / Rubber feet	4	ポリウレタン / Polyurethane	透明 / Transparent

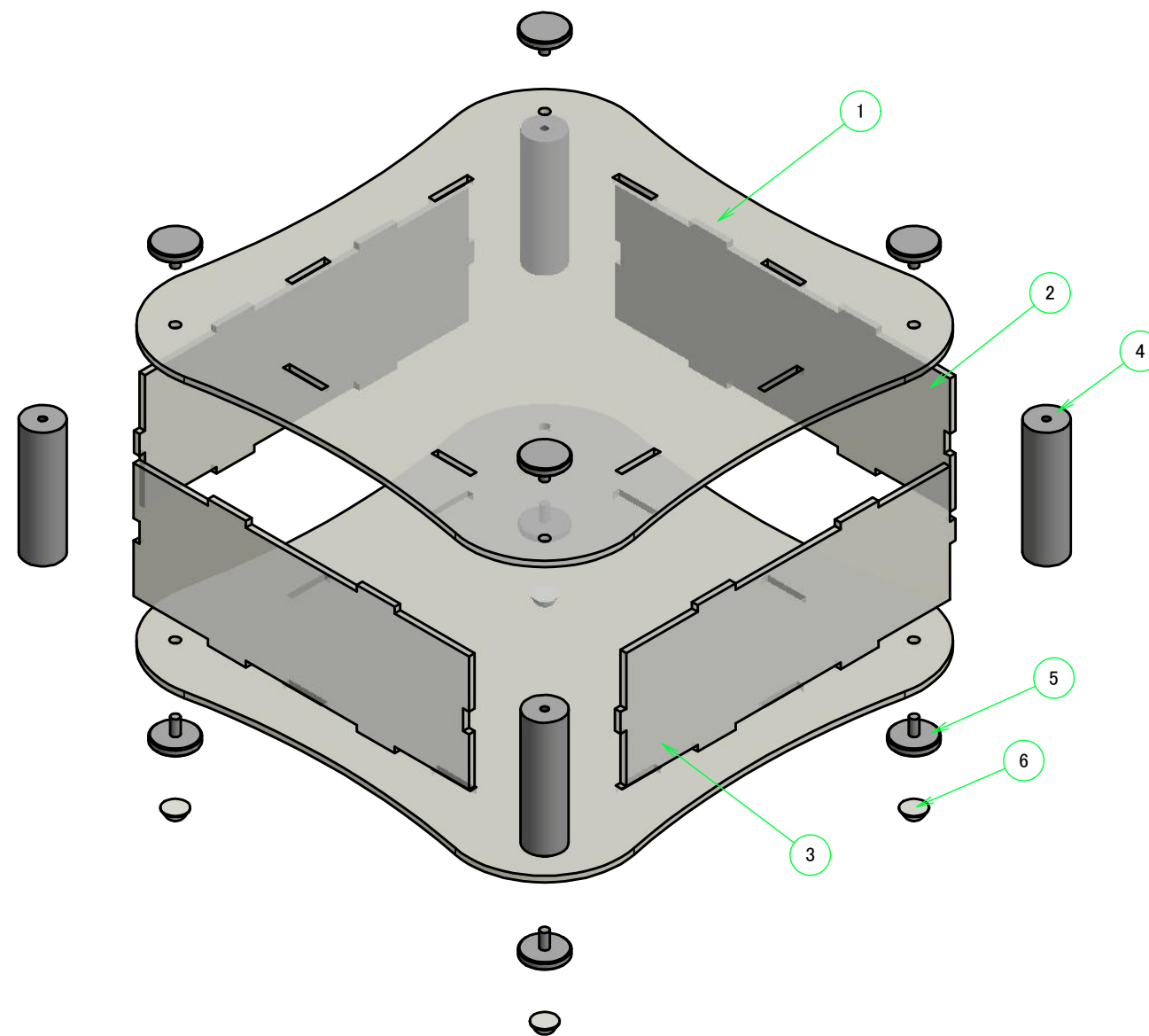

取付用ローレットビス / Knurled Thumb Screw

ゴム足 / Rubber feet

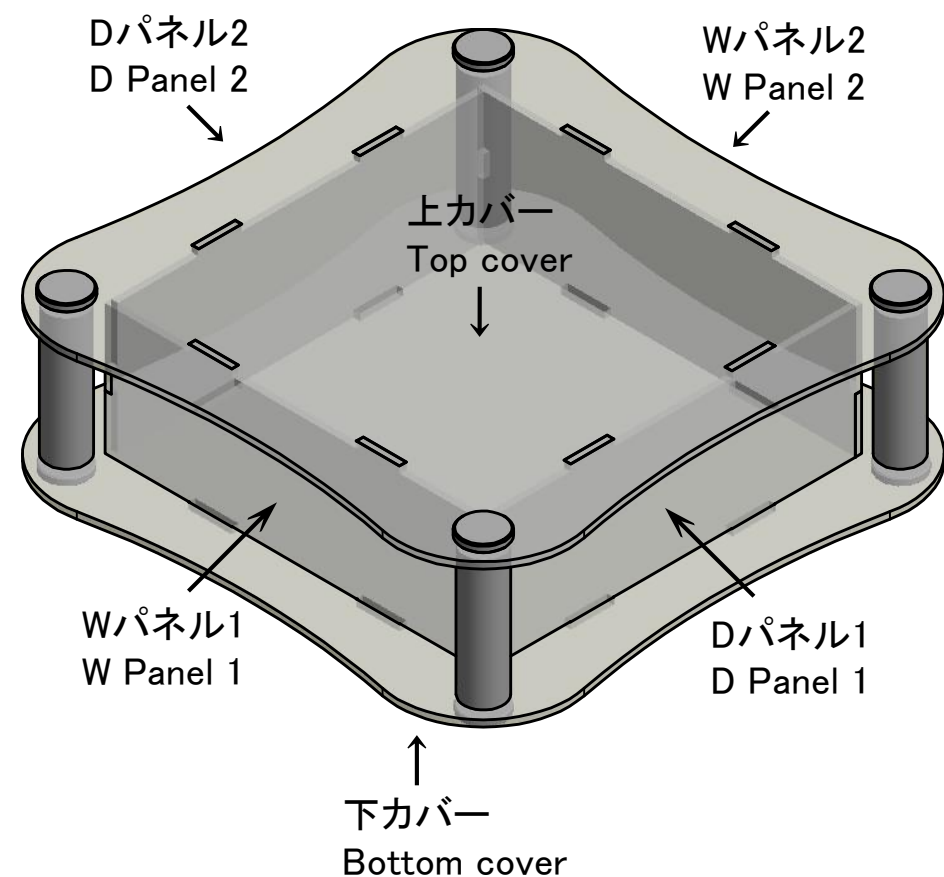
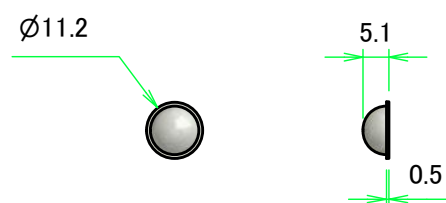
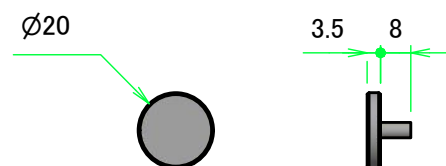

\*ゴム足は任意の位置に貼り付けできます。  
\*Adhesive rubber feet in cluded

株式会社タカチ電機工業 TAKACHI ELECTRONICS ENCLOSURE CO., LTD.			品名/Title スケルトンケース SKELETON CASE	尺度/Scale 1:2.5
承認/Approved 中根	検図/Checked 横田	製図/Created 常山	型番/Product number SKL18-7-18	
			作成日/Date 2020/10/28	1 / 5

外視 / External View

Wパネル2 / W Panel 2

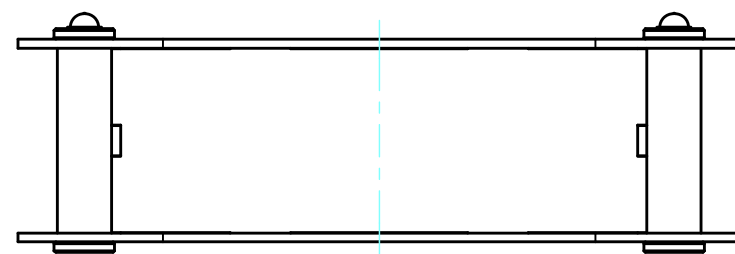

Dパネル2 / D Panel 2

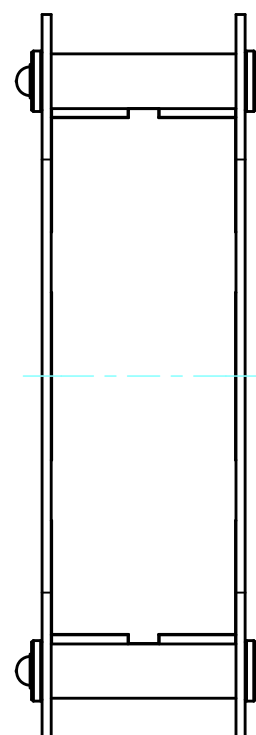

上カバー / Top cover

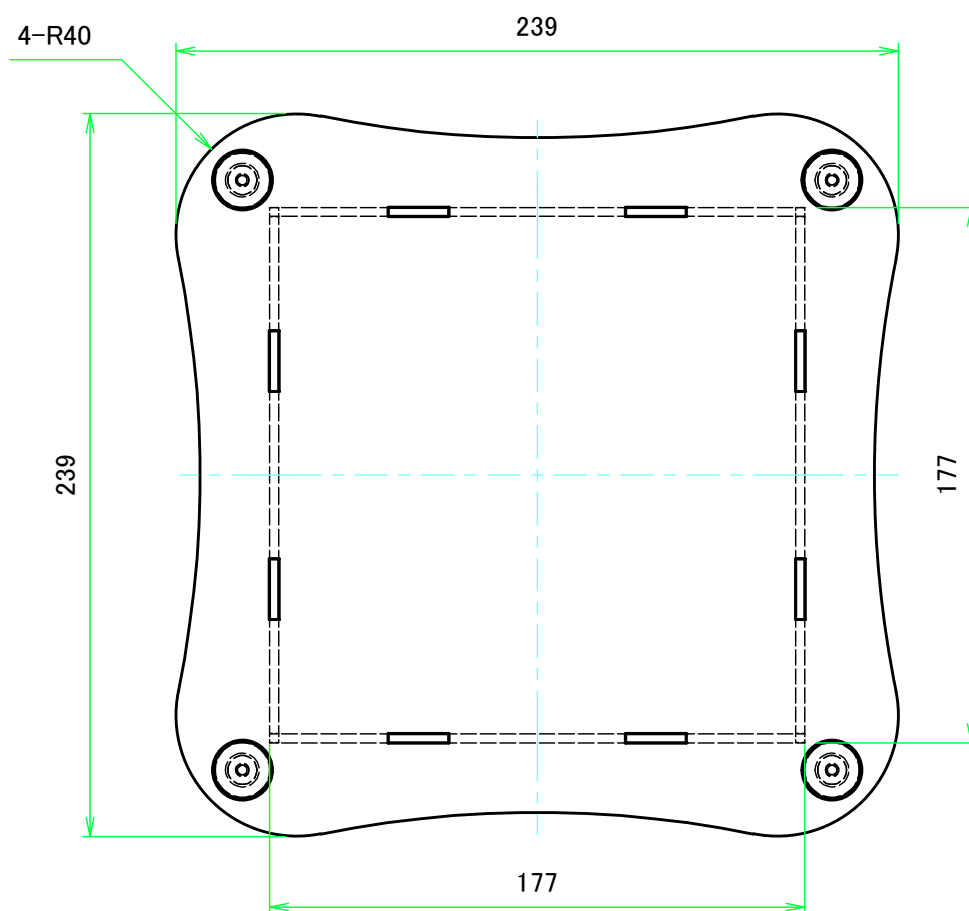

Dパネル1 / D Panel 1

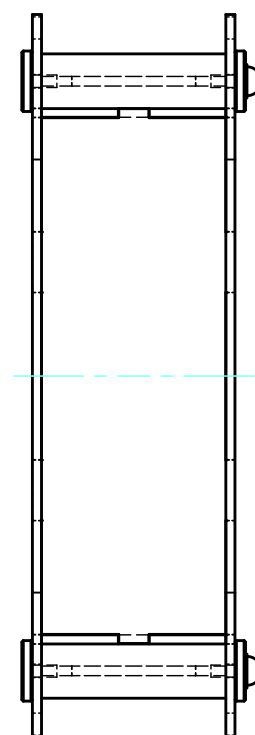

下カバー / Bottom cover

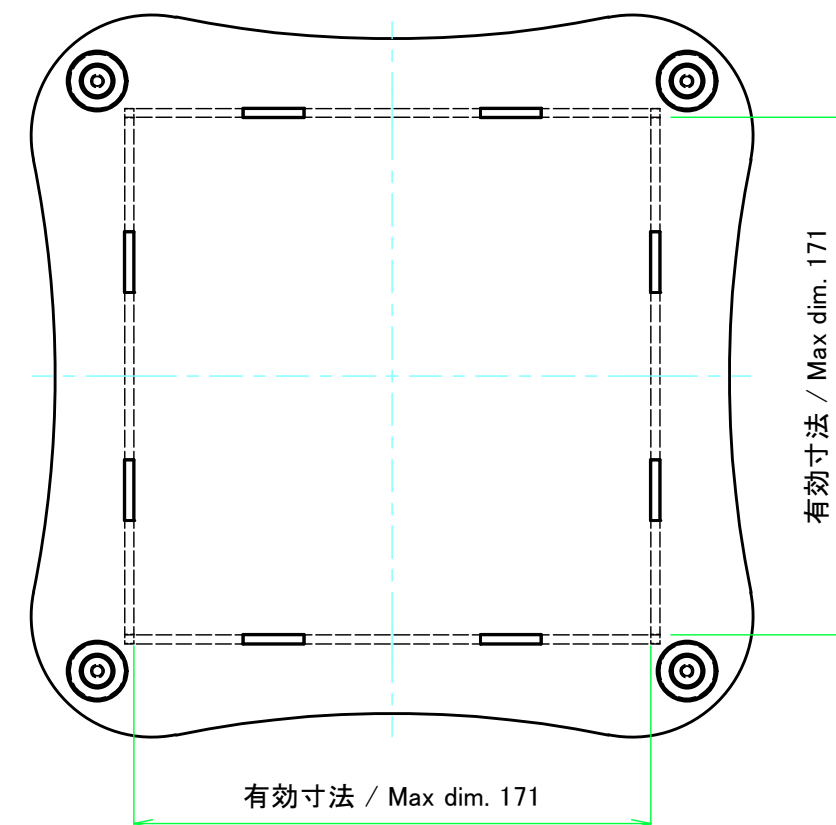

Wパネル1 / W Panel 1

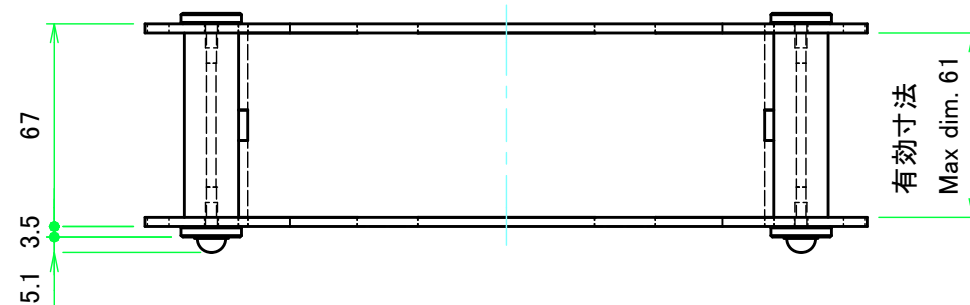

株式会社タカチ電機工業 TAKACHI ELECTRONICS ENCLOSURE CO., LTD.			品名/Title スケルトンケース SKELETON CASE	尺度/Scale 1:2.5
承認/Approved	検図/Checked	製図/Created	型番/Product number SKL18-7-18	
中根	横田	常山	作成日/Date 2020/10/28	2 / 5

上下カバー / Top and Bottom cover

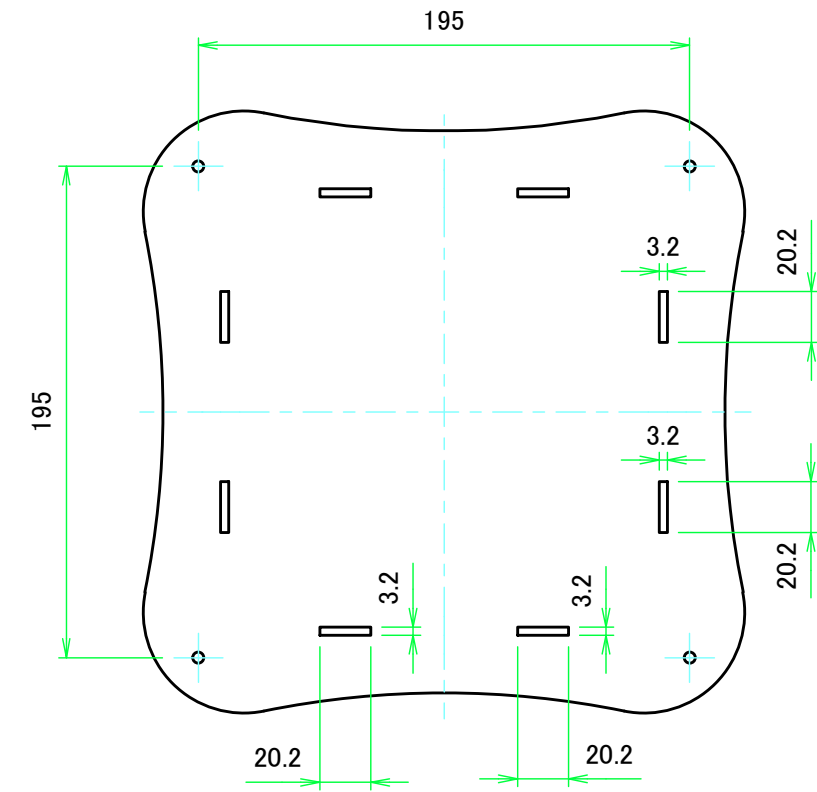
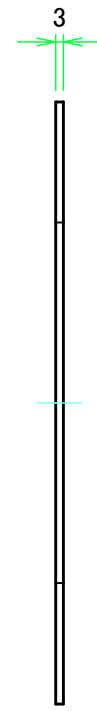
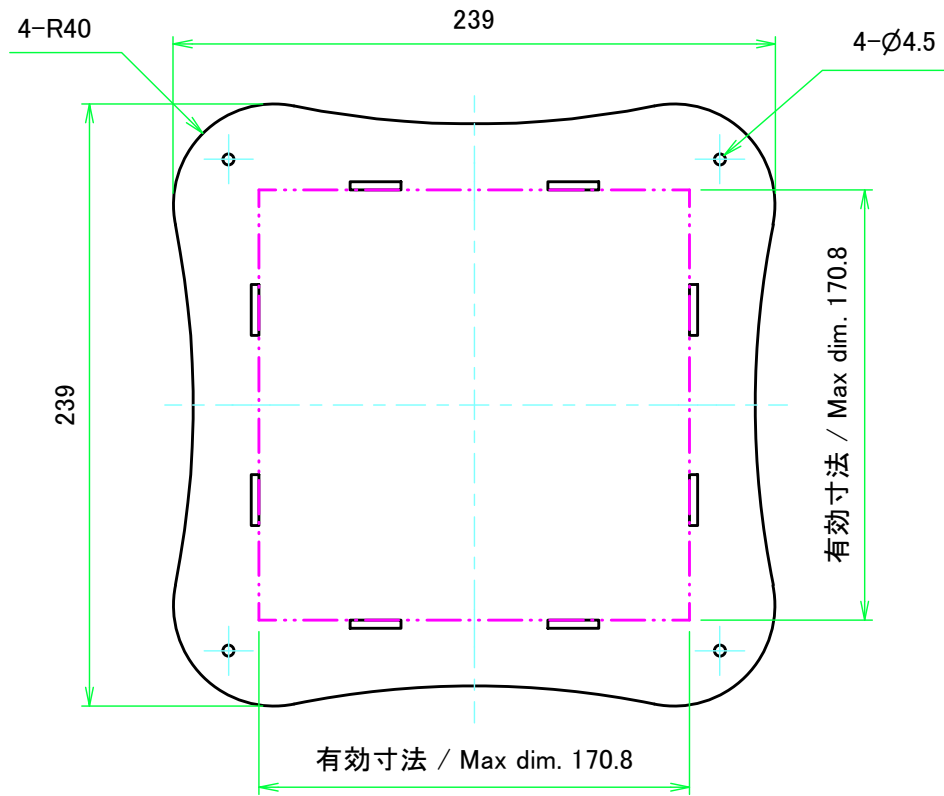

上カバー表面 / Top cover Frontside

上カバー裏面 / Top cover Backside

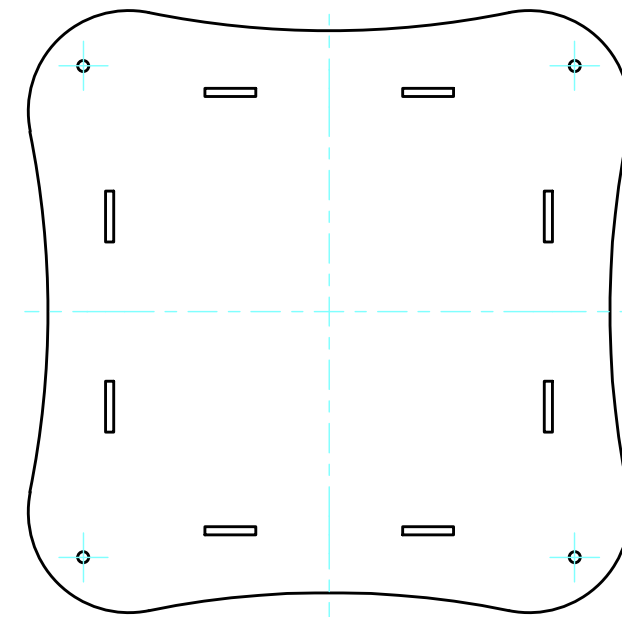
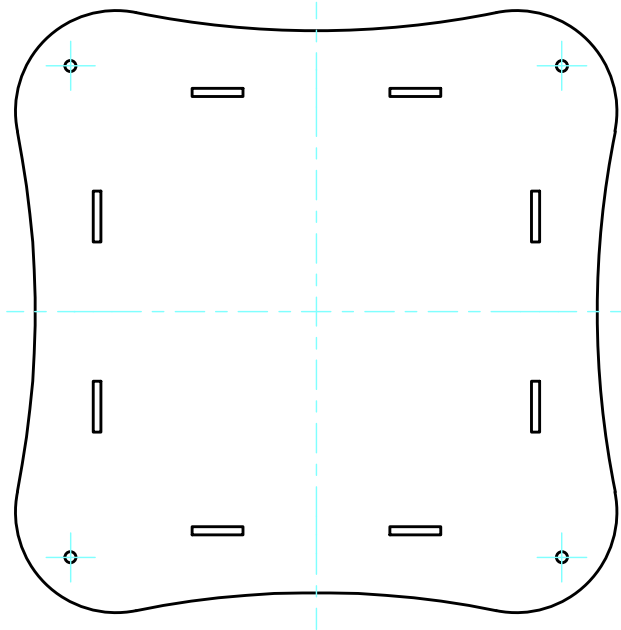

下カバー表面 / Bottom cover Frontside

下カバー裏面 / Bottom cover Backside

株式会社タカチ電機工業 TAKACHI ELECTRONICS ENCLOSURE CO., LTD.			品名/Title スケルトンケース SKELETON CASE	尺度/Scale 1:3
承認/Approved	検図/Checked	製図/Created	型番/Product number SKL18-7-18	
中根	横田	常山	作成日/Date 2020/10/28	3 / 5

Wパネル / W Panel

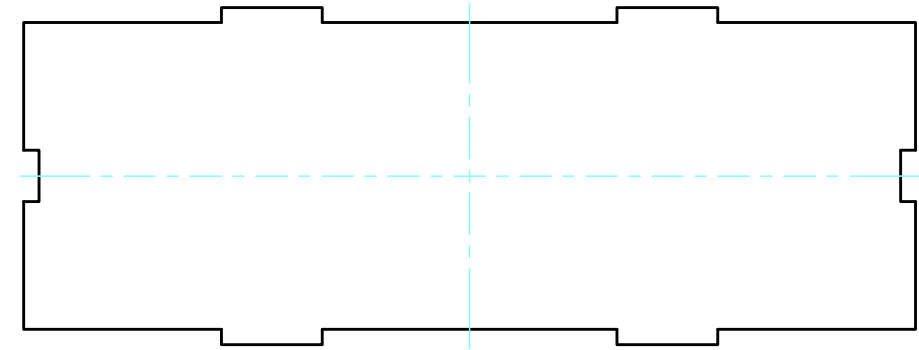
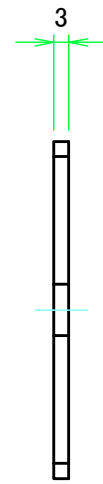
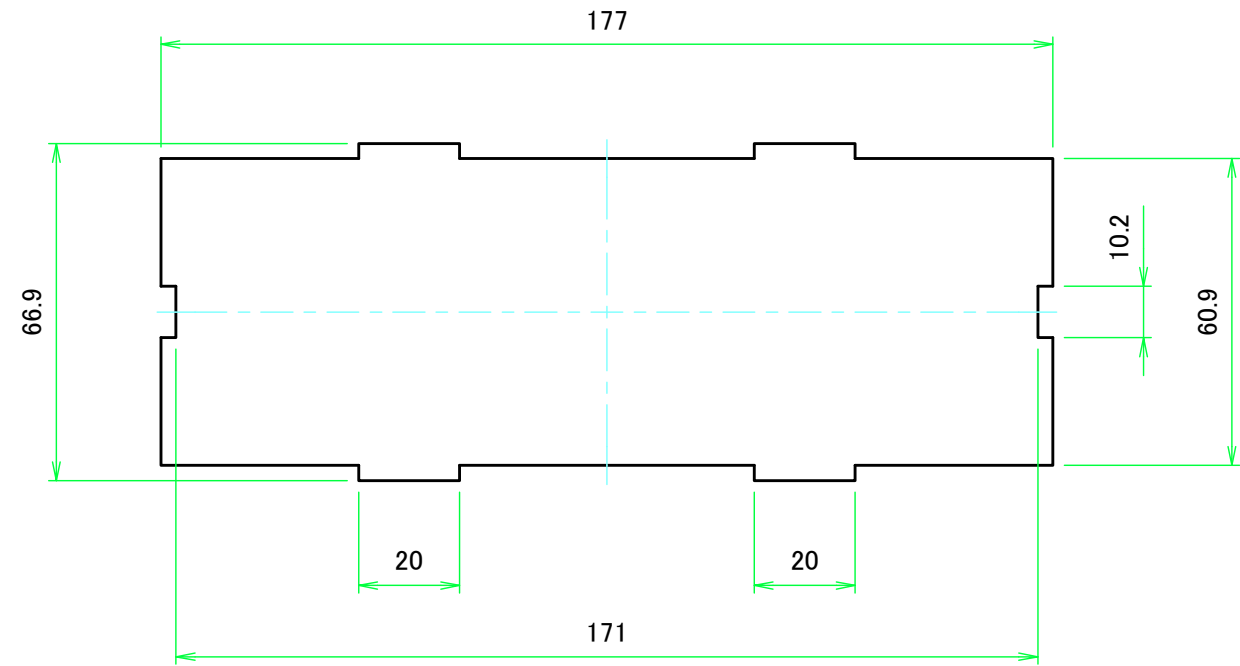

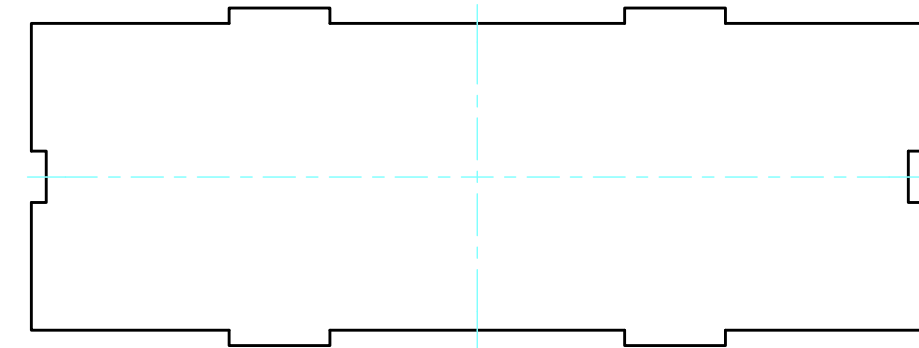
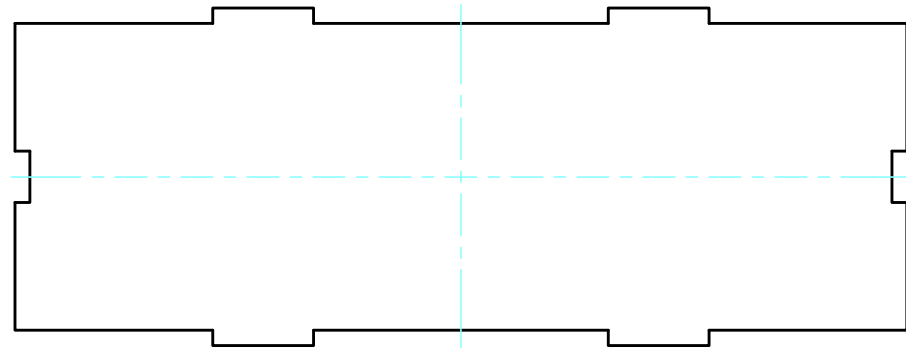

Wパネル1表面 / W Panel 1 Frontside

Wパネル1裏面 / W Panel 1 Backside



Wパネル2表面 / W Panel 2 Frontside

Wパネル2裏面 / W Panel 2 Backside

 株式会社タカチ電機工業 TAKACHI ELECTRONICS ENCLOSURE CO., LTD.			品名/Title スケルトンケース SKELETON CASE	 尺度/Scale 1:1.5
承認/Approved 中根	検図/Checked 横田	製図/Created 常山	型番/Product number SKL18-7-18	
			作成日/Date 2020/10/28	4 / 5

Dパネル / D Panel

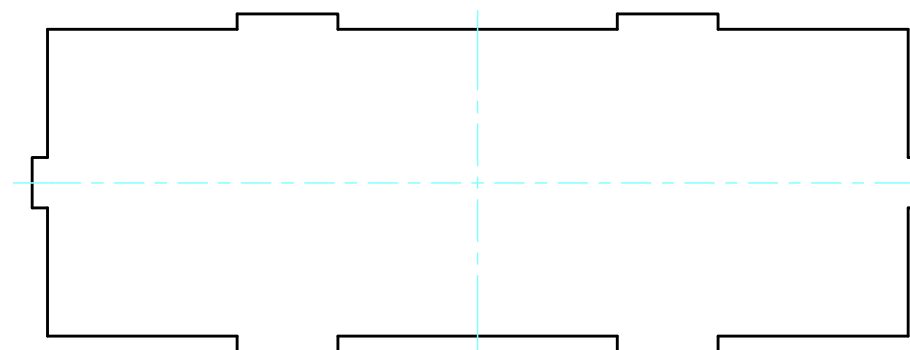
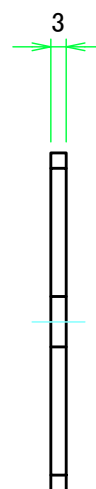
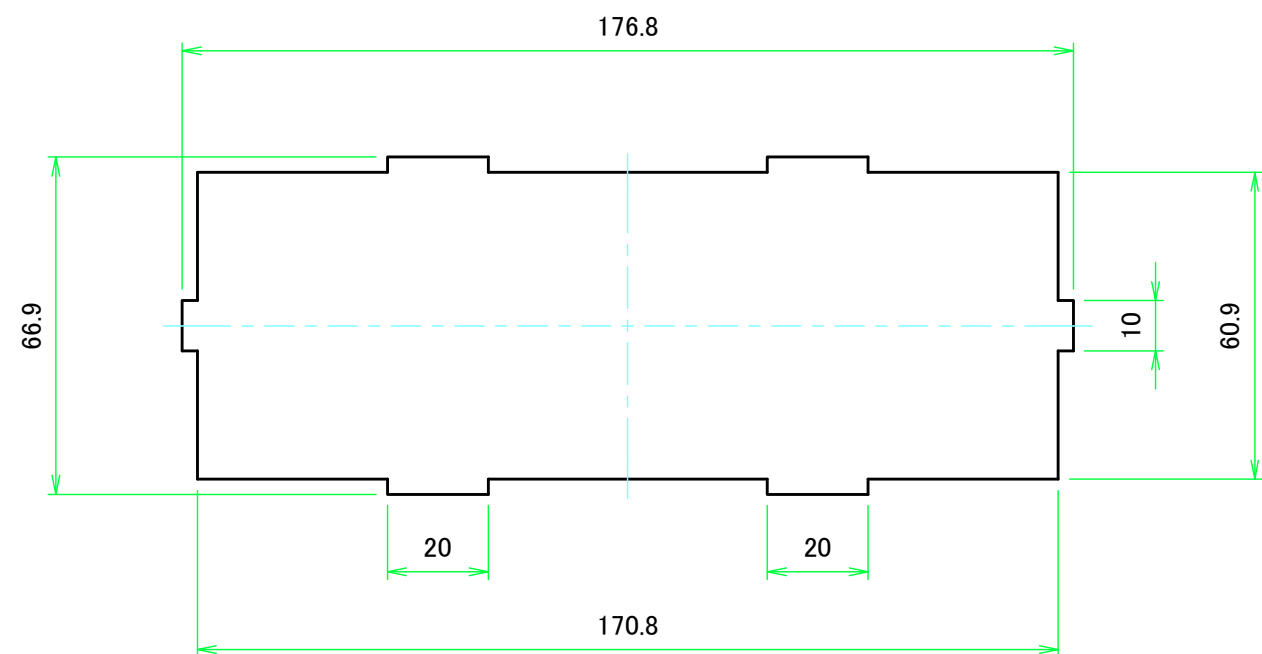

Dパネル1表面 / D Panel 1 Frontside

Dパネル1裏面 / D Panel 1 Backside

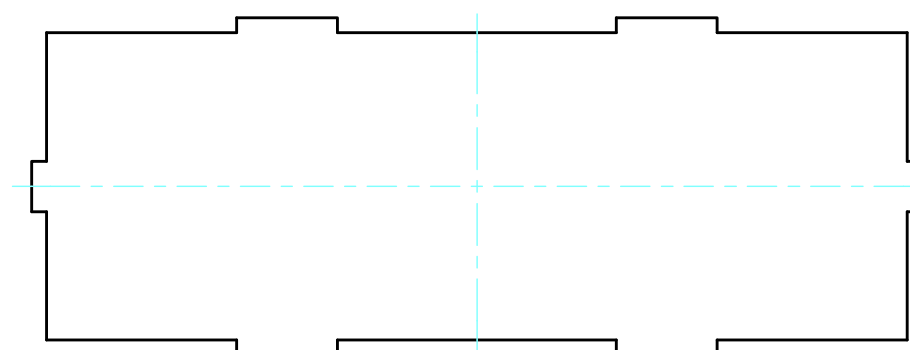
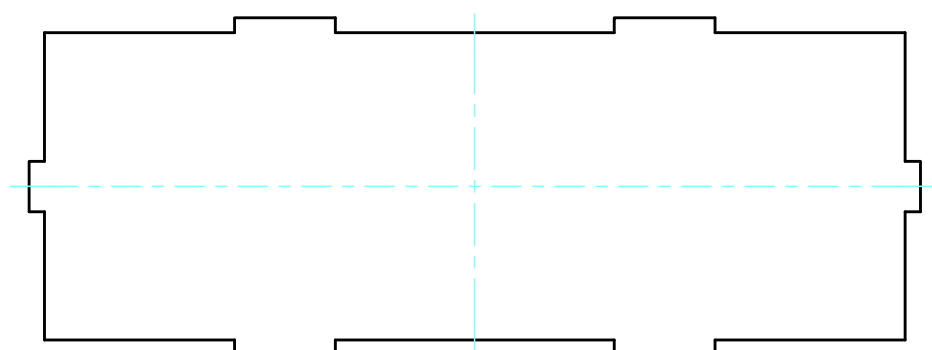

Dパネル2表面 / D Panel 2 Frontside

Dパネル2裏面 / D Panel 2 Backside

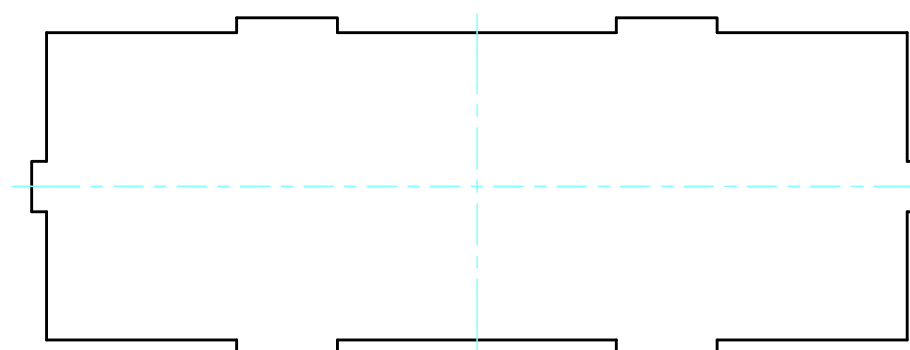
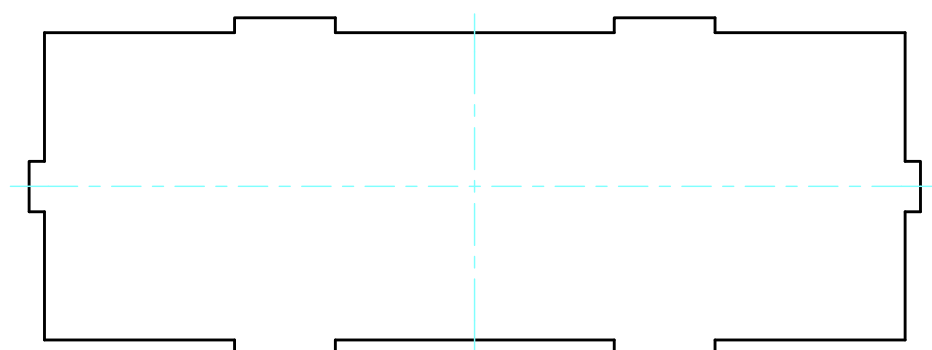

株式会社タカチ電機工業 TAKACHI ELECTRONICS ENCLOSURE CO., LTD.		品名/Title スケルトンケース SKELETON CASE	尺度/Scale 1:1.5
承認/Approved	検図/Checked	製図/Created	
中根	横田	常山	作成日/Date 2020/10/28
			5 / 5