

| 構成内容 / Components | | | | |
|-------------------|---|--------------|--|------------------------------|
| No. | 名称 / Part name | 数量 / Pcs | 材質 / Material | 色・表面処理 / Color・Finish |
| 1 | 上下カバー Top and Bottom cover | 各1 1 each | アクリル板 t3.0 Acrylic t3.0 | 透明 Transparent |
| 2 | Wパネル W panel | 2 | アクリル板 t3.0 Acrylic t3.0 | 透明 Transparent |
| 3 | Dパネル D panel | 2 | アクリル板 t3.0 Acrylic t3.0 | 透明 Transparent |
| 4 | 支柱 Extruded pillar | 4 | アルミ押出材 A6063S-T5 Extruded aluminium A6063S-T5 | シルバーアルマイト Silver anodized |
| 5 | 取付用ローレットビス (M4 x 8) Knurled thumb screw (M4 - 8) | 8 | 真ちゅう Brass | ニッケルメッキ Nickel plated |
| 6 | ゴム足 / Rubber feet | 0 or 5 | ポリウレタン / Polyurethane | 透明 / Transparent |

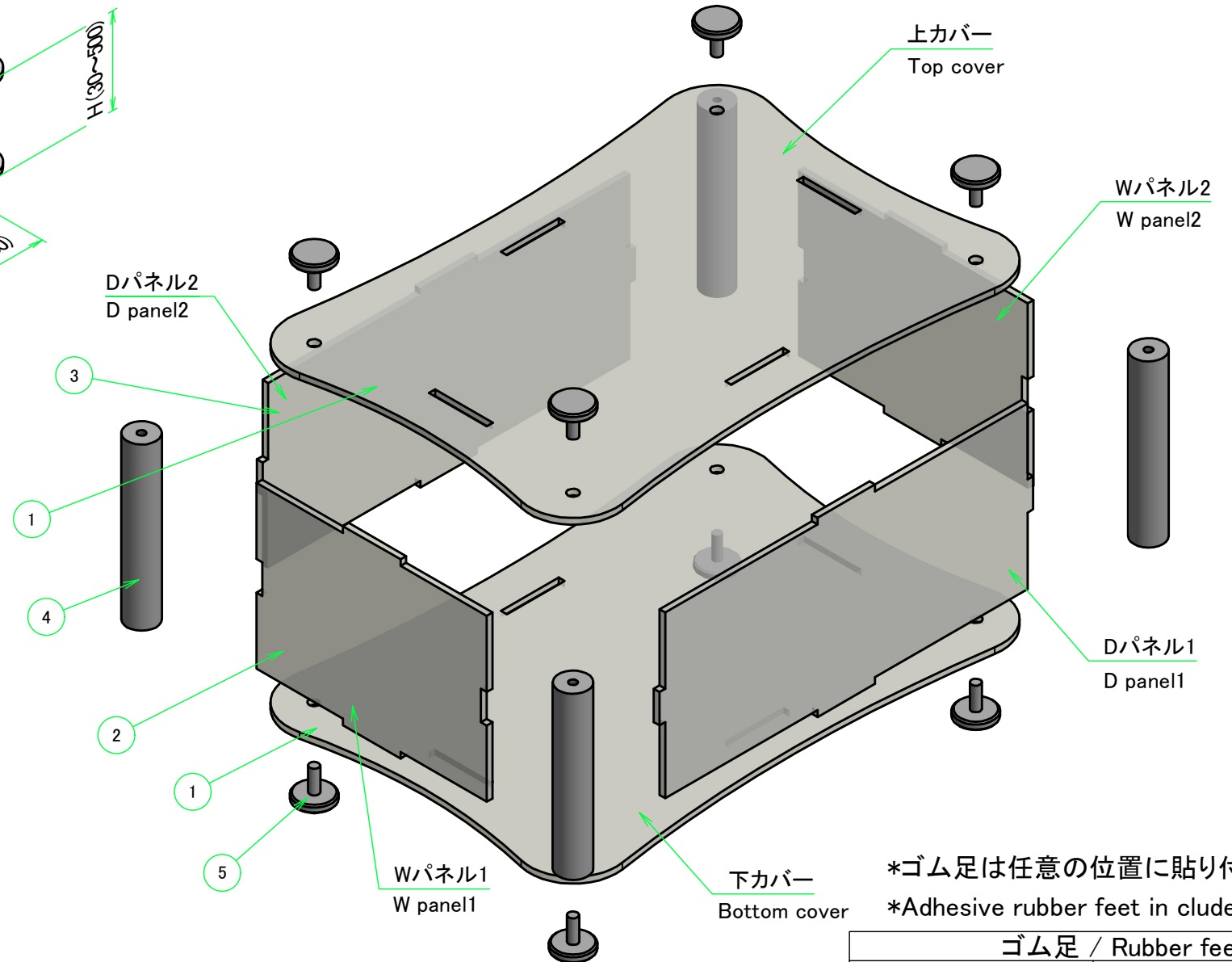

ケース型番 / Product Number

SKLF - - S18
 W H D タイプ ゴム足
 Type Rubber feet

*ゴム足は任意の位置に貼り付けできます。
 *Adhesive rubber feet in cluded

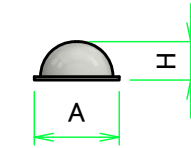

| ゴム足 / Rubber feet | | |
|-------------------|------|-----|
| 記号 / Code | A | H |
| N (無し) / None | - | - |
| S | 11.2 | 5.1 |
| L | 15.7 | 7.9 |

| W・H・D 寸法制限範囲 / Dimension limit range | | |
|--------------------------------------|----------|----------|
| W | H | D |
| 351 ~ 400 | 30 ~ 500 | 50 ~ 100 |

| | | | | |
|---|------------|------------|--|-------------------|
| TAKACHI 株式会社タカチ電機工業 TAKACHI ELECTRONICS ENCLOSURE CO., LTD. | | | 品名/Title スケルトンフリーサイズケース CUSTOM SIZED SKELETON CASE | |
| 承認/Approved | 検図/Checked | 製図/Created | 型番/Product number SKLF□-□-□S18□ (W351~400, D50~100) | |
| 中根 | 野村 | 常山 | 作成日/Date 2021/04/26 | 尺度/Scale 1 / 5 |

外視 / External View

Wパネル2 / W panel 2



Dパネル2 / D panel 2

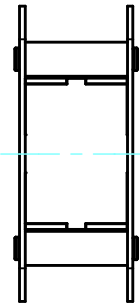

上カバー / Top cover

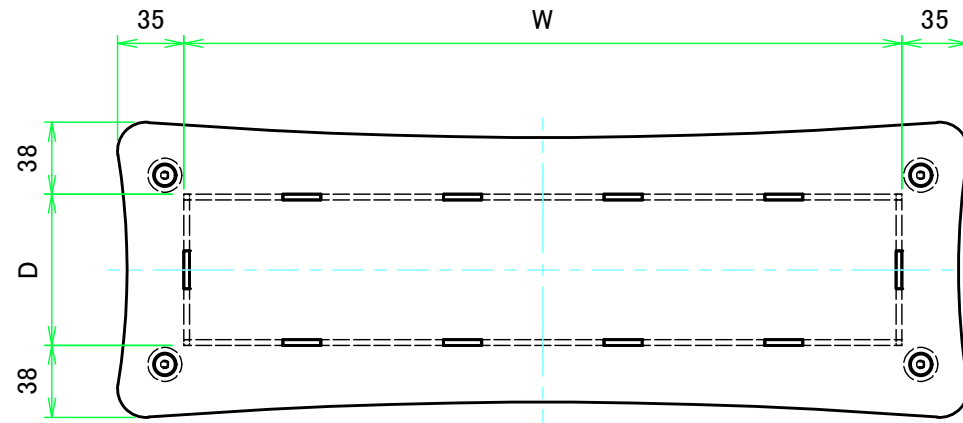

Dパネル1 / D panel 1

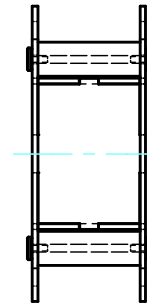

下カバー / Bottom cover

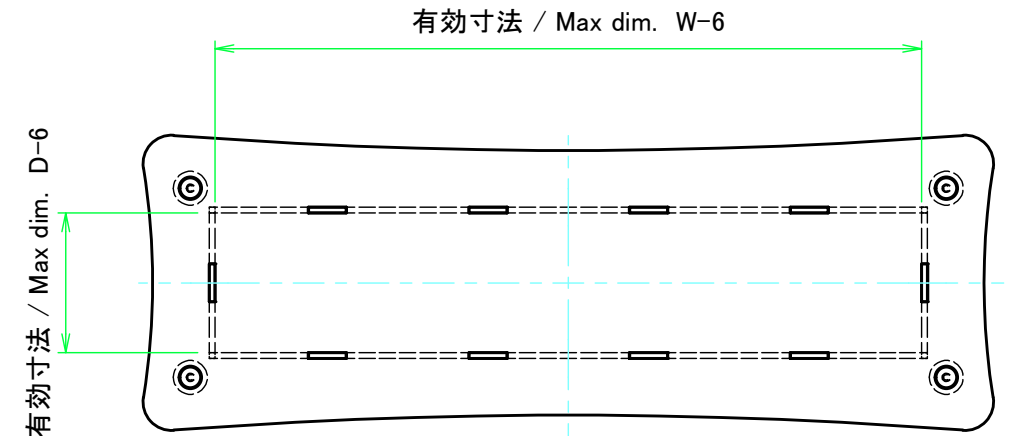

Wパネル1 / W panel 1

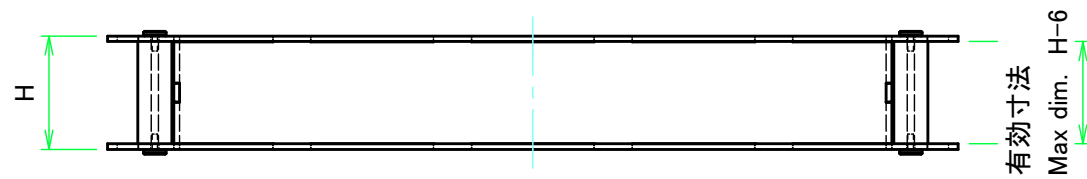

| | | | | |
|--|------------|------------|--|-----------------|
| 株式会社タカチ電機工業 <small>TAKACHI ELECTRONICS ENCLOSURE CO., LTD.</small> | | | 品名/Title スケルトンフリーサイズケース CUSTOM SIZED SKELETON CASE | 尺度/Scale 1:4 |
| 承認/Approved | 検図/Checked | 製図/Created | 型番/Product number SKLF□-□-□S18□ (W351~400, D50~100) | |
| 中根 | 野村 | 常山 | 作成日/Date 2021/04/26 | 2 / 5 |

上下カバー / Top and Bottom cover

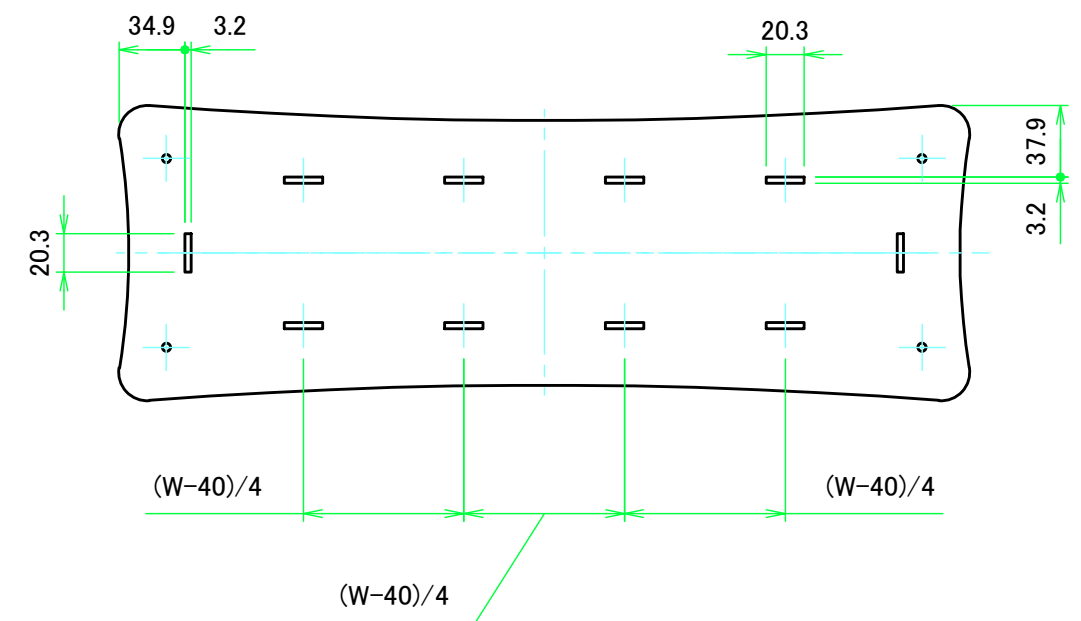
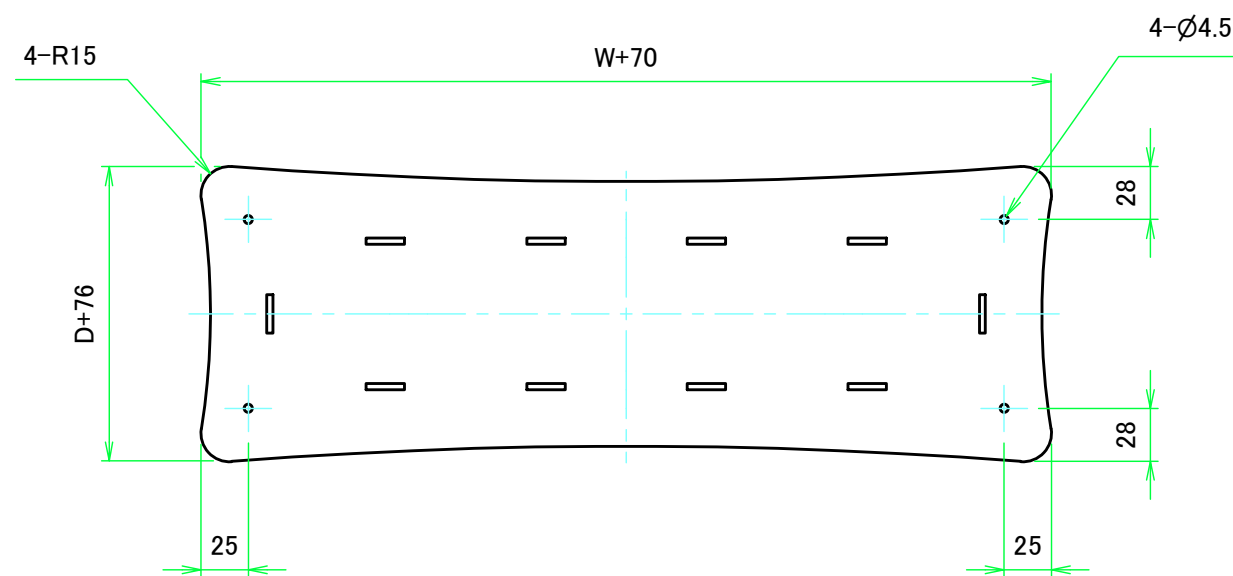

上カバー表面 / Top cover Frontside

上カバー裏面 / Top cover Backside

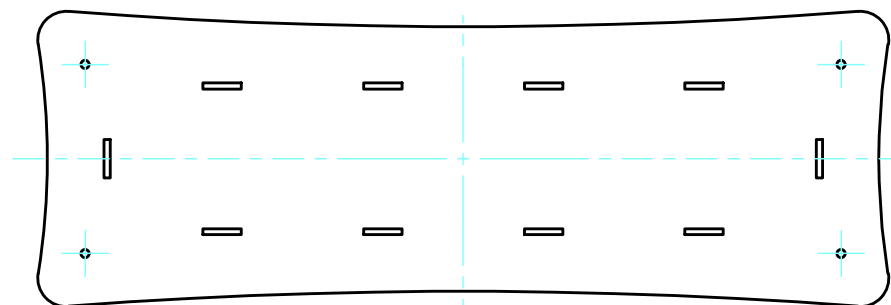
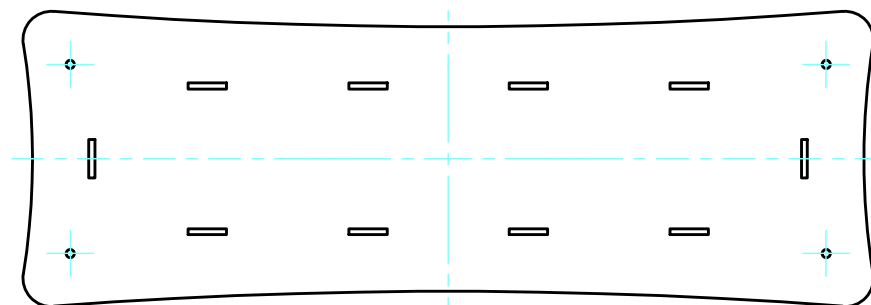

下カバー表面 / Bottom cover Frontside

下カバー裏面 / Bottom cover Backside

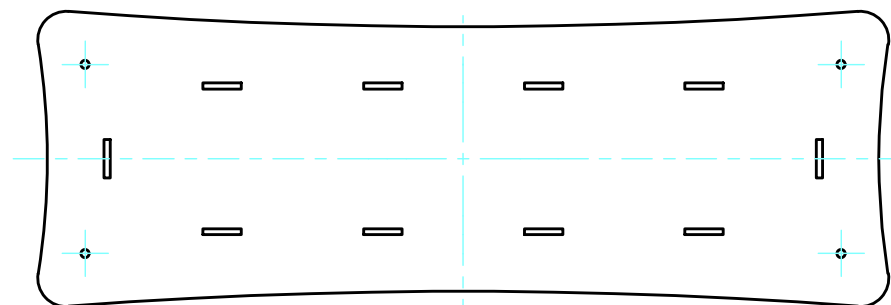
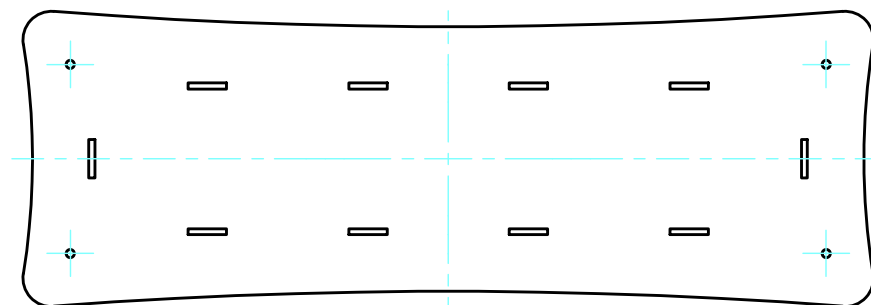

| | | | | |
|--|------------|------------|--|-----------------|
| 株式会社タカチ電機工業 TAKACHI ELECTRONICS ENCLOSURE CO., LTD. | | | 品名/Title スケルトンフリーサイズケース CUSTOM SIZED SKELETON CASE | 尺度/Scale 1:4 |
| 承認/Approved | 検図/Checked | 製図/Created | 型番/Product number SKLF□-□-□S18□ (W351~400, D50~100) | |
| 中根 | 野村 | 常山 | 作成日/Date 2021/04/26 | 3 / 5 |

Wパネル / W panel

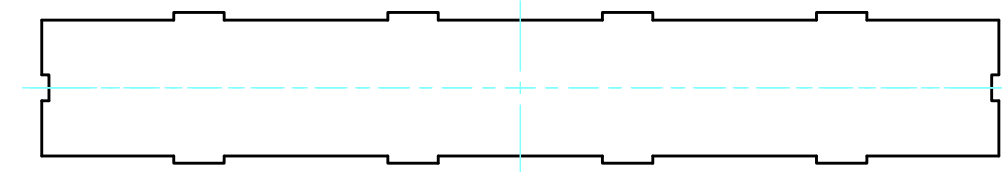
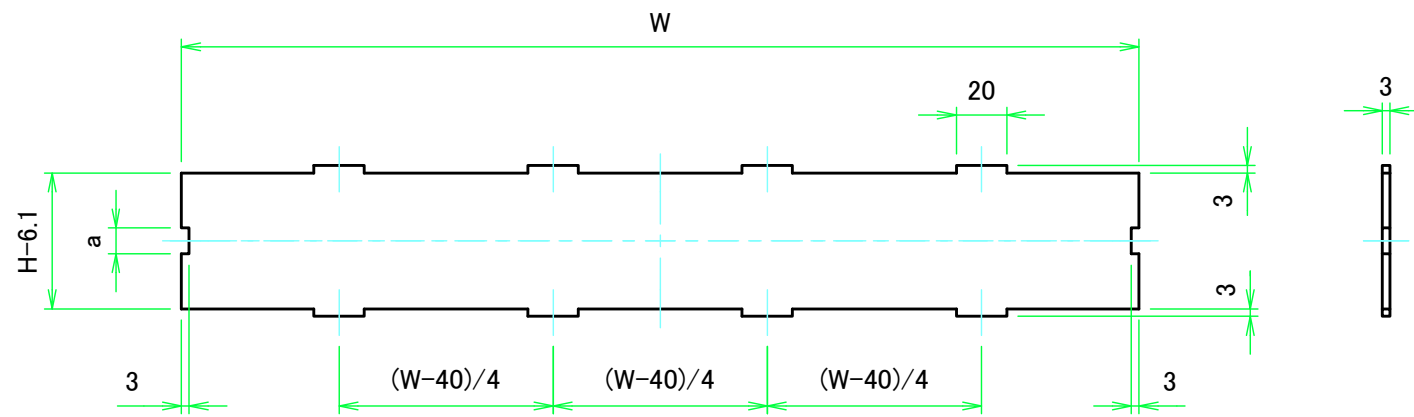

Wパネル1表面 / W panel 1 Frontside

Wパネル1裏面 / W panel 1 Backside

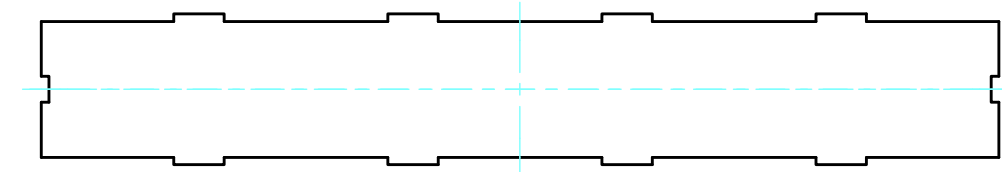
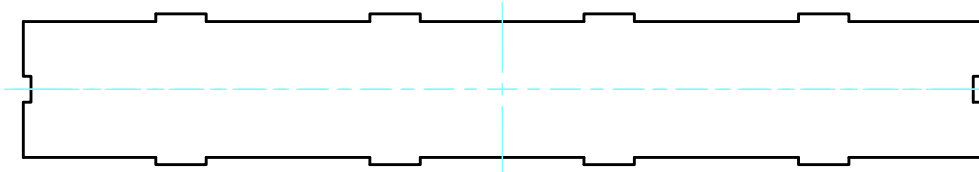

Wパネル2表面 / W panel 2 Frontside

Wパネル2裏面 / W panel 2 Backside

※高さ(H)寸法によりハメ込み部aの寸法、箇所数が異なります。下記表をご確認ください。
 Number of joints vary by specified H dimensions. Refer to the below chart for more information

| H寸法 / H dimension | ハメ込み部a / joint a dimension | 箇所数(片面) / Joints(one side) |
|-------------------|----------------------------|----------------------------|
| 30 ~ 100 | 10.2 | 1 |
| 101 ~ 200 | 20.2 | 1 |
| 201 ~ 300 | 20.2 | 2 |
| 301 ~ 400 | 20.3 | 3 |
| 401 ~ 500 | 20.3 | 4 |

| | | | | |
|--|------------|------------|--|-----------------|
| 株式会社タカチ電機工業 TAKACHI ELECTRONICS ENCLOSURE CO., LTD. | | | 品名/Title スケルトンフリーサイズケース CUSTOM SIZED SKELETON CASE | 尺度/Scale 1:3 |
| 承認/Approved | 検図/Checked | 製図/Created | 型番/Product number SKLF□-□-□S18□ (W351~400, D50~100) | |
| 中根 | 野村 | 常山 | 作成日/Date 2021/04/26 | 4 / 5 |

Dパネル / D panel

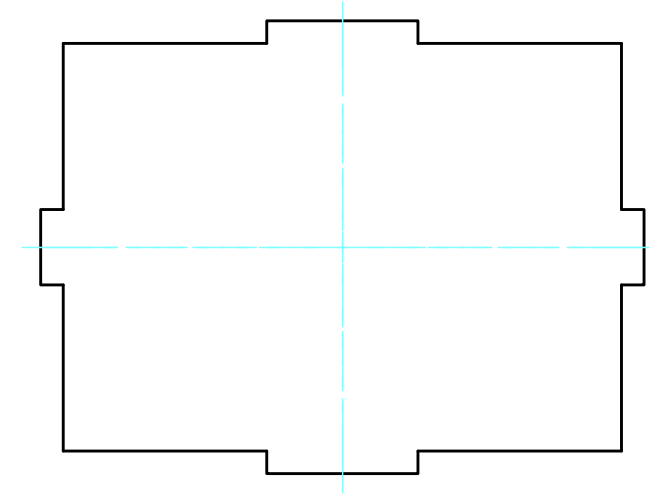
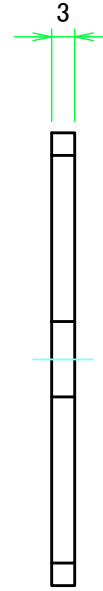
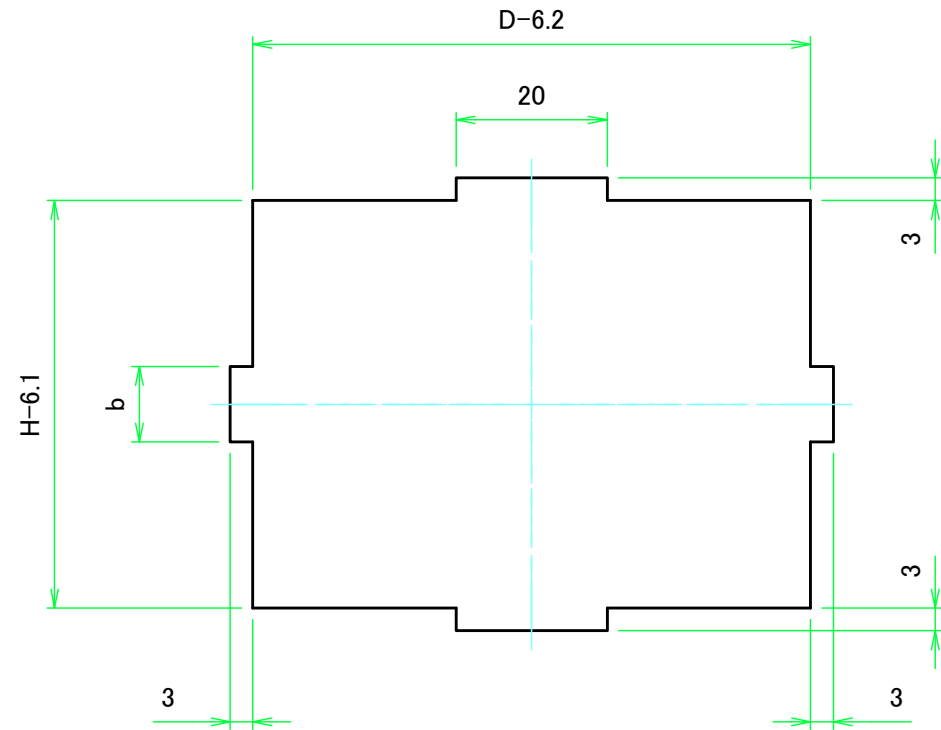

Dパネル1表面 / D panel 1 Frontside

Dパネル1裏面 / D panel 1 Backside

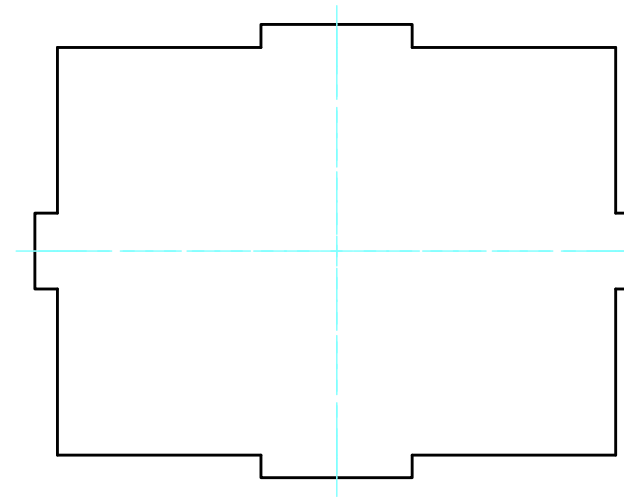
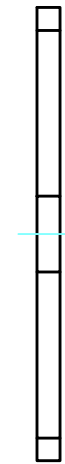
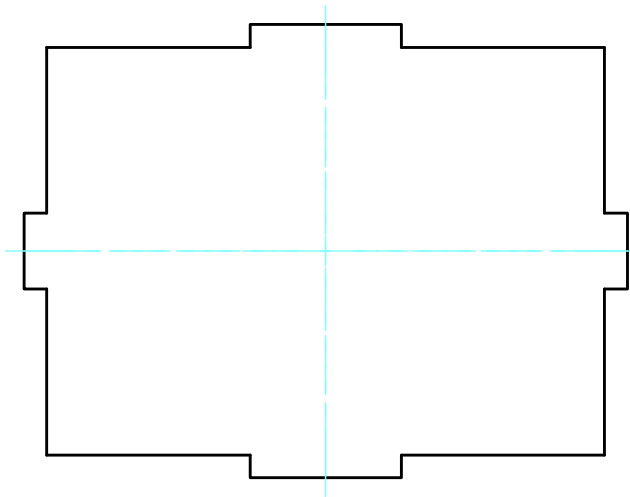

Dパネル2表面 / D panel 2 Frontside

Dパネル2裏面 / D panel 2 Backside

※高さ(H)寸法によりハメ込み部bの寸法、箇所数が異なります。下記表をご確認下さい。

Number of joints vary by specified H dimensions. Refer to the below chart for more information

| H寸法 / H dimension | ハメ込み部b / joint b dimension | 箇所数(片面) / Joints(one side) |
|-------------------|----------------------------|----------------------------|
| 30 ~ 100 | 10 | 1 |
| 101 ~ 200 | 20 | 1 |
| 201 ~ 300 | 20 | 2 |
| 301 ~ 400 | 20 | 3 |
| 401 ~ 500 | 20 | 4 |

| | | | | |
|--|------------|------------|--|-----------------|
| 株式会社タカチ電機工業 <small>TAKACHI ELECTRONICS ENCLOSURE CO., LTD.</small> | | | 品名/Title スケルトンフリーサイズケース CUSTOM SIZED SKELETON CASE | 尺度/Scale 1:1 |
| 承認/Approved | 検図/Checked | 製図/Created | 型番/Product number SKLF□-□-□S18□ (W351~400, D50~100) | |
| 中根 | 野村 | 常山 | 作成日/Date 2021/04/26 | 5 / 5 |