

構成内容 / Components				
No.	名称 / Part name	数量 / Pcs	材質 / Material	色・表面処理 / Color・Finish
1	上カバー Top cover	1	アルミ押出材 Extruded aluminium A6063S-T5	ライトグレー, ブラック・塗装 Light gray, Black・Painted
2	下カバー Bottom cover	1	アルミ押出材 Extruded aluminium A6063S-T5	ライトグレー, ブラック・塗装 Light gray, Black・Painted
3	パネル Panel	2	アルミ板 A1100P t1.5 Aluminium A1100P t1.5	ライトグレー, ブラック・塗装 Light gray, Black・Painted
4	サイド金具 / Joint plate	2	鋼板 / Steel SPC t2.0	三価クロメート / Trivalent chromate
5	取付ビス(サラ M3 x 5) Screw(Countersunk M3 - 5)	12	鉄 Steel	三価黒クロメート Black trivalent chromate
6	ゴム足 / Rubber feet	4	合成ゴム / Rubber	ブラック / Black

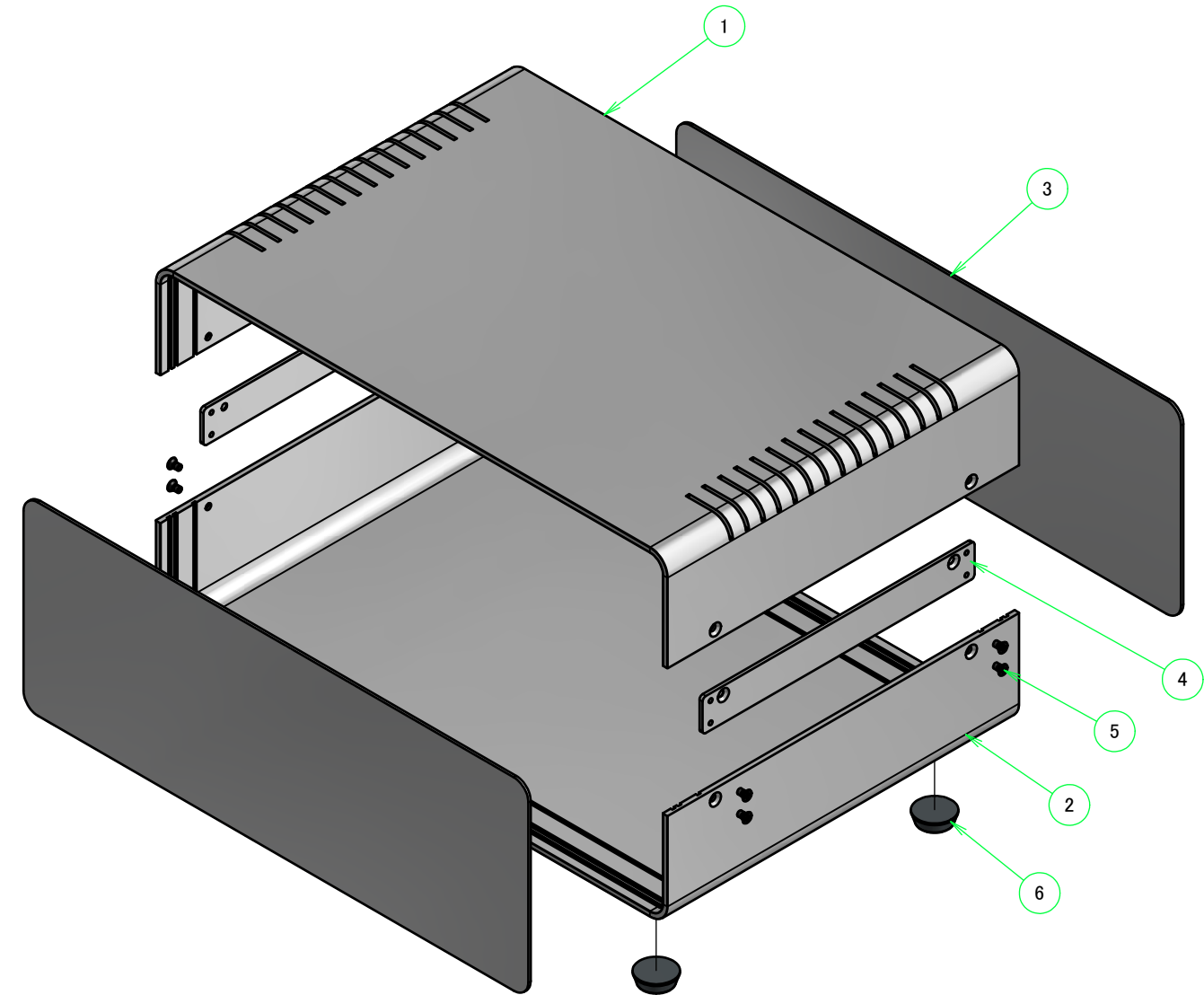
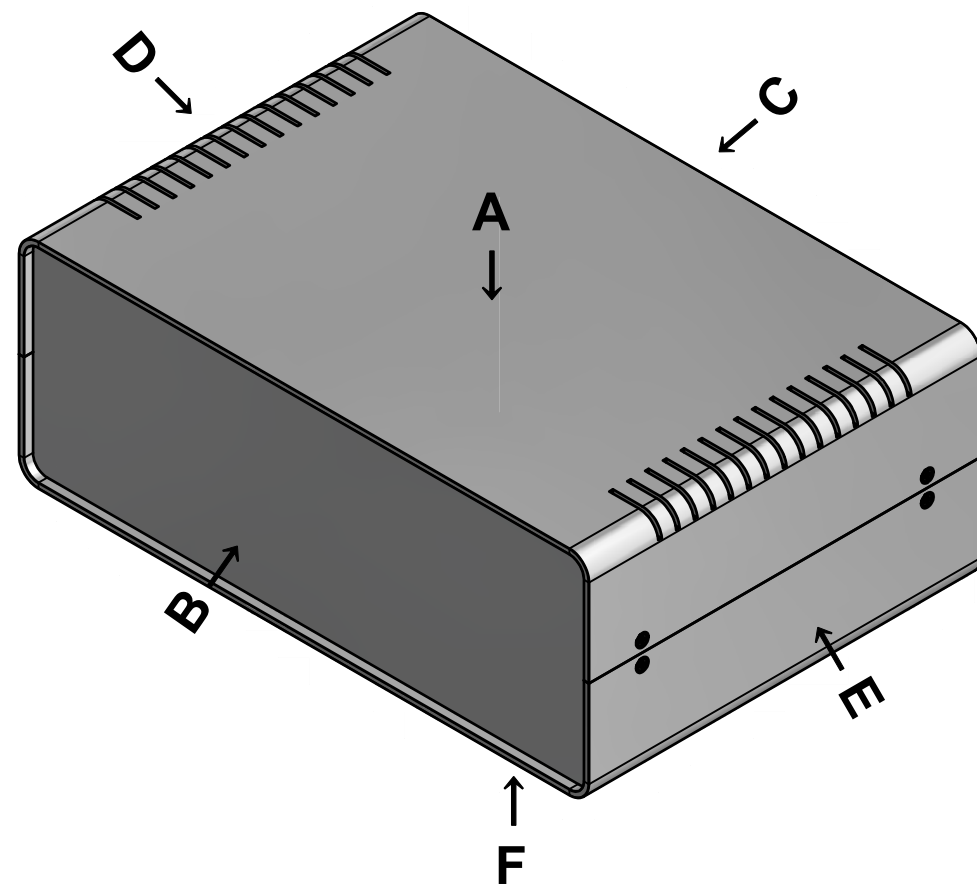
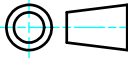

* ゴム足は任意の場所に貼り付けできます。
* Adhesive rubber feet included.

色仕様(型番末尾□) / Color type (End of product number□)		
記号 / Code	上下カバー / Top・Bottom cover	パネル / Panel
GG	ライトグレー / Light gray	ライトグレー / Light gray
BB	ブラック / Black	ブラック / Black

TAKACHI 株式会社タカチ電機工業 TAKACHI ELECTRONICS ENCLOSURE CO., LTD.		品名/Title ユニバーサルアルミサッシケース UNIVERSAL ALUMINIUM CASE	 尺度/Scale 1:3
承認/Approved 中根	検図/Checked 大江	製図/Created 横田	
		型番/Product number UC32-12-22□	1 / 4
		作成日/Date 2020/01/21	

外視 / External View

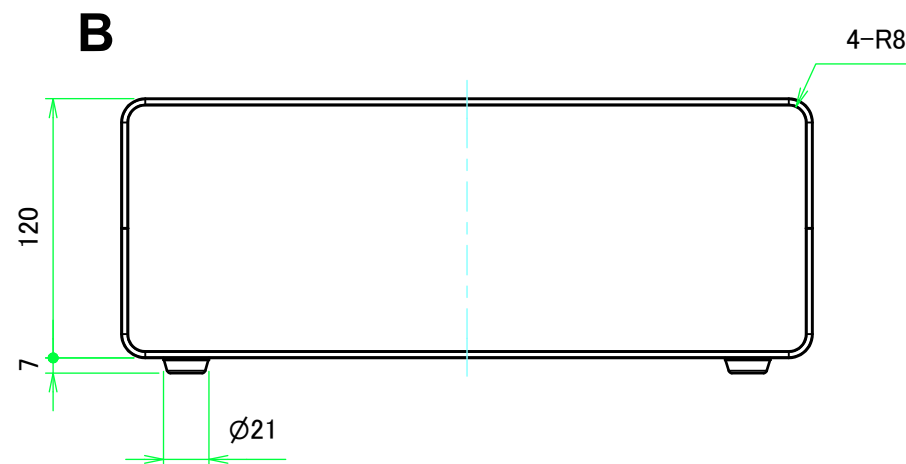
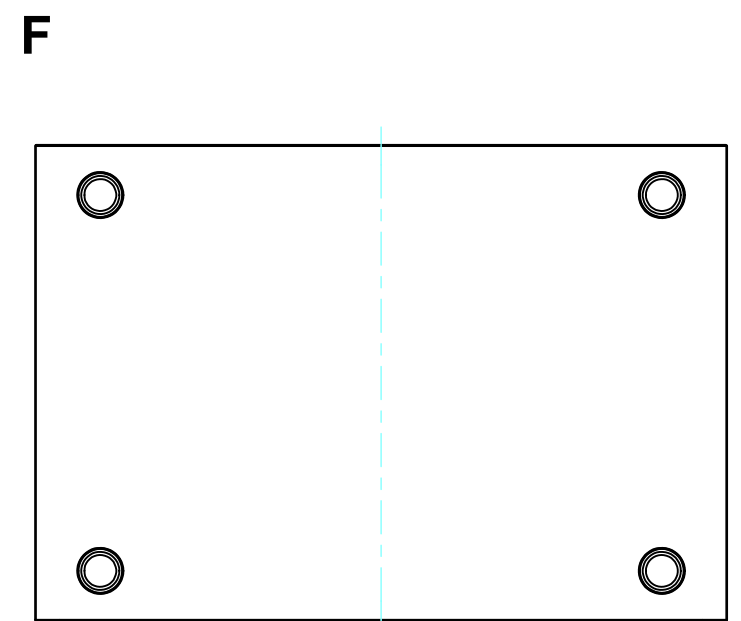
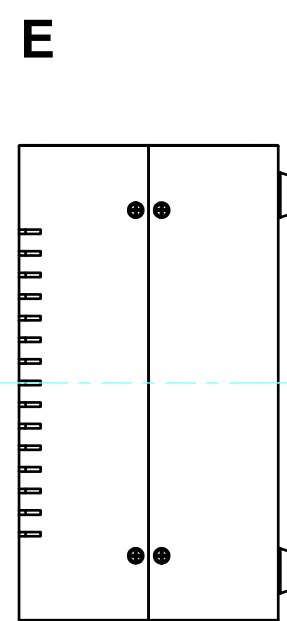
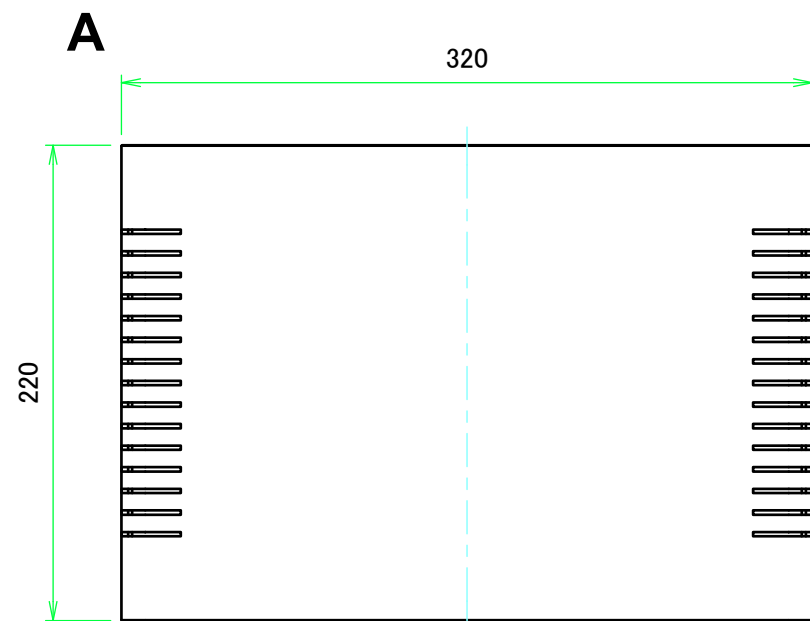
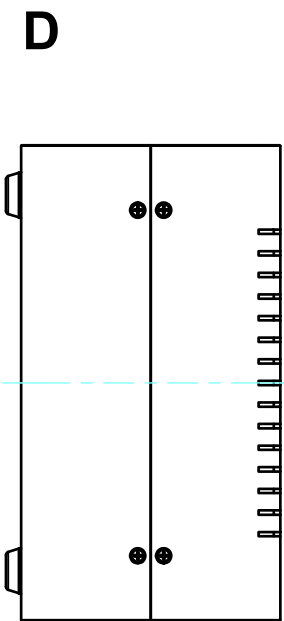
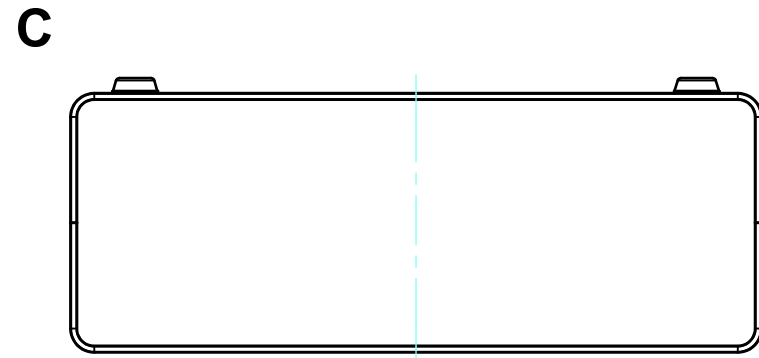

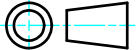
 株式会社タカチ電機工業 TAKACHI ELECTRONICS ENCLOSURE CO., LTD.			品名/Title ユニバーサルアルミサッシケース UNIVERSAL ALUMINIUM CASE	 尺度/Scale 1:3.5
承認/Approved 中根	検図/Checked 大江	製図/Created 横田	型番/Product number UC32-12-22□ 作成日/Date 2020/01/21	

内視 / Internal View

C-C (1:3.5)

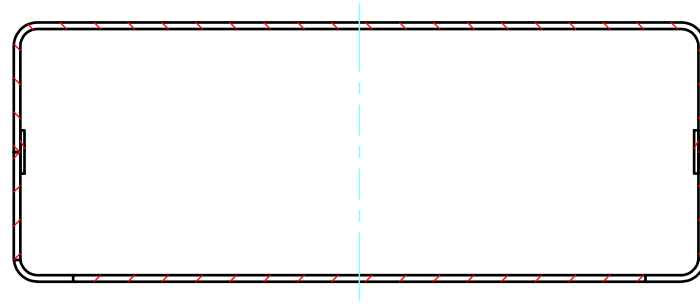

下カバー(内視)
Bottom cover (Internal view)

A-A (1:3.5)

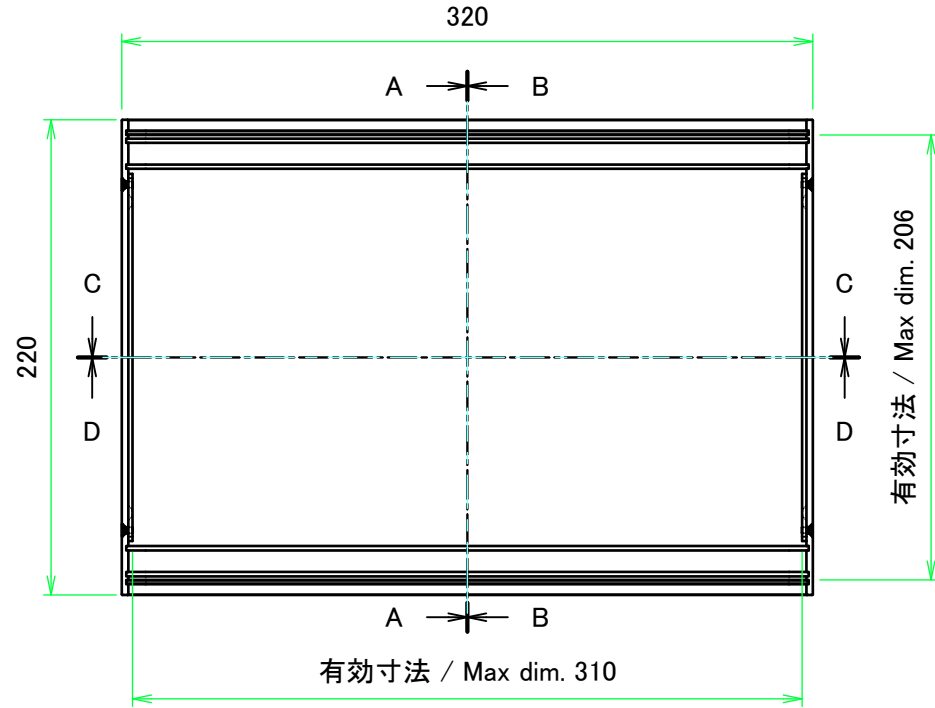
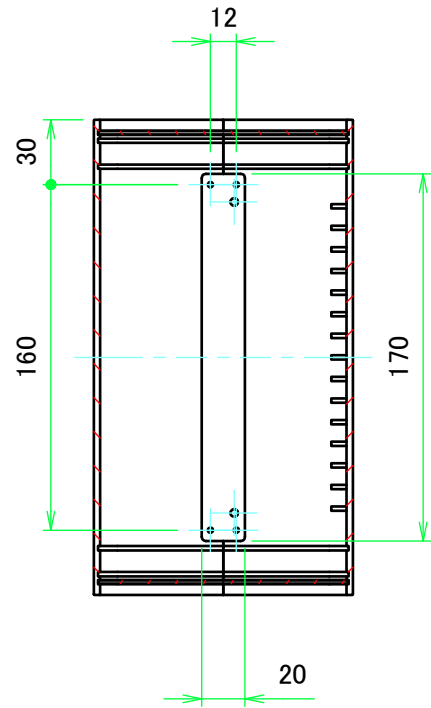

B-B (1:3.5)

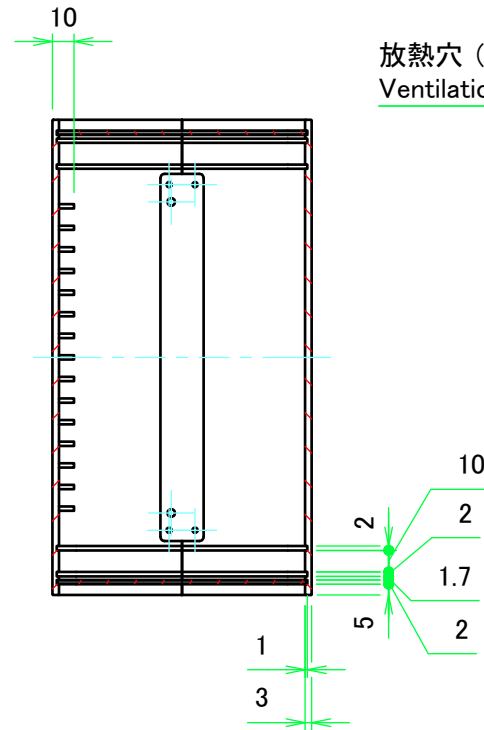

放熱穴 (2x30 P10)
Ventilation slits (2x30 P10)

上カバー(内視)
Top cover (Internal view)

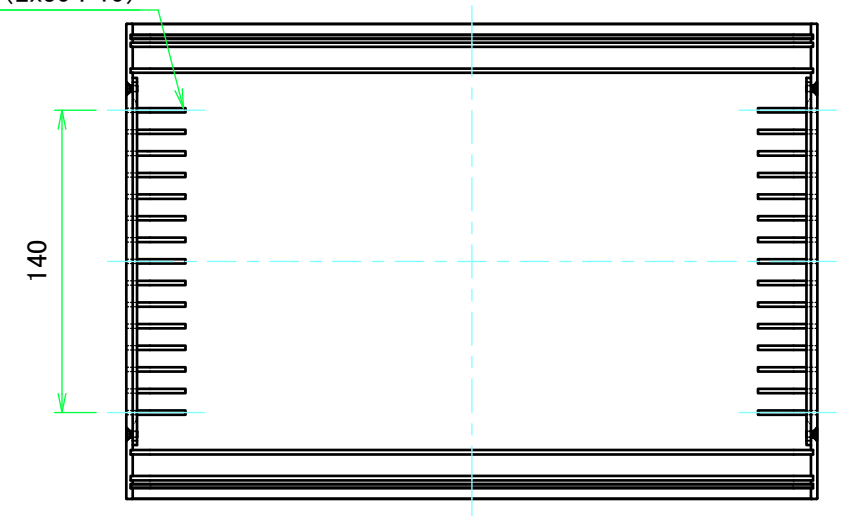

4-R8 D-D (1:3.5)

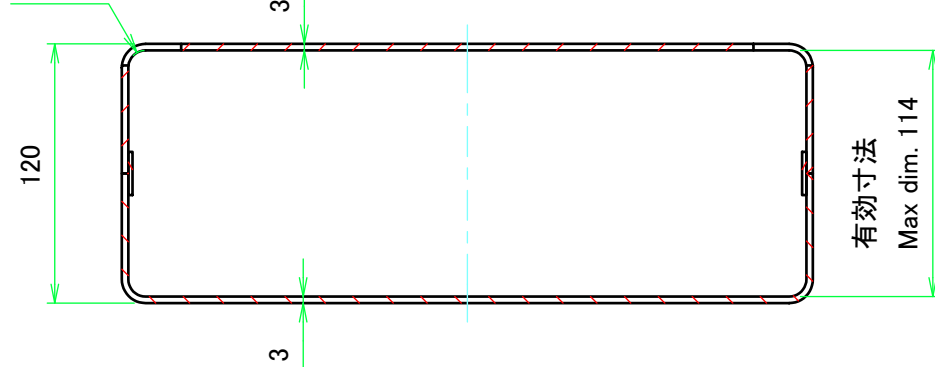

株式会社タカチ電機工業 TAKACHI ELECTRONICS ENCLOSURE CO., LTD.			品名/Title ユニバーサルアルミサッシケース UNIVERSAL ALUMINIUM CASE	尺度/Scale 1:3.5
承認/Approved	検図/Checked	製図/Created	型番/Product number UC32-12-22□	
中根	大江	横田	作成日/Date 2020/01/21	3 / 4

パネル / Panel

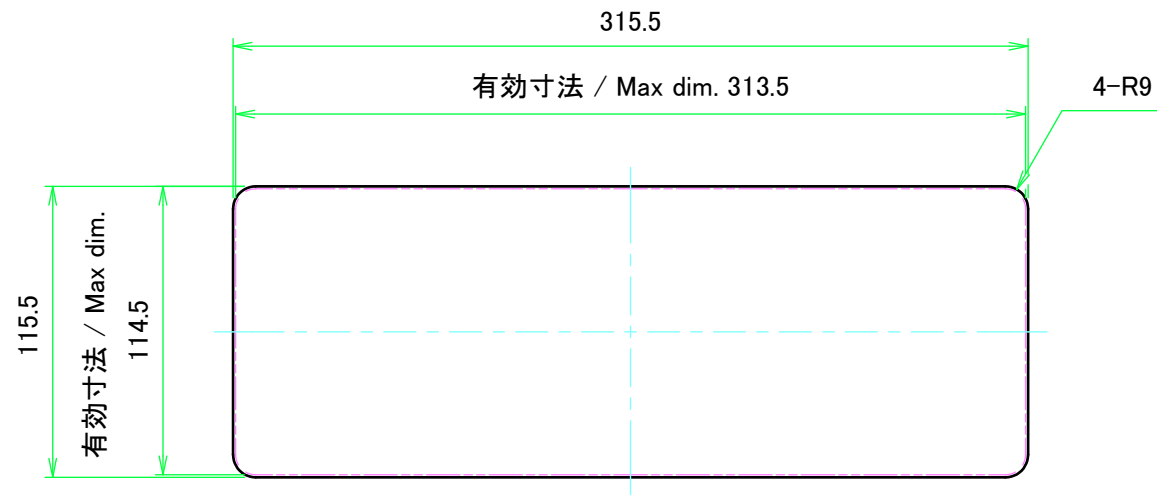

保護シート面
Surface protective film side

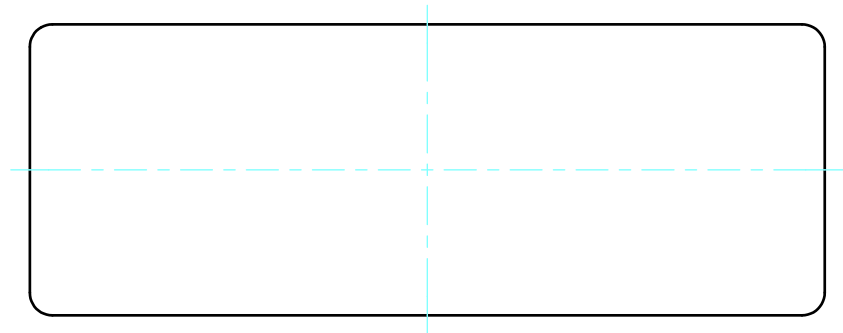

パネル表面 / Panel Frontside

パネル裏面 / Panel Backside

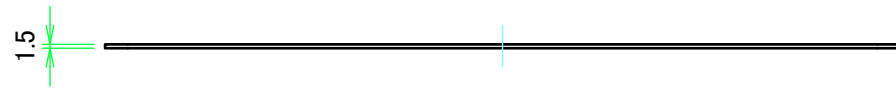

保護シート面
Surface protective film side

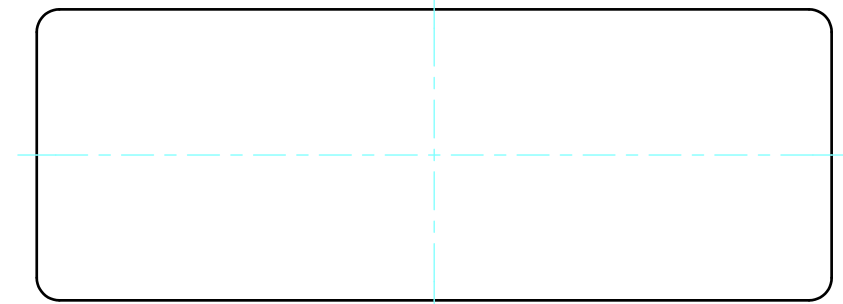

パネル表面 / Panel Frontside

パネル裏面 / Panel Backside

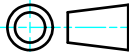

 株式会社タカチ電機工業 TAKACHI ELECTRONICS ENCLOSURE CO., LTD.			品名/Title ユニバーサルアルミサッシケース UNIVERSAL ALUMINIUM CASE	 尺度/Scale 1:3
承認/Approved 中根	検図/Checked 大江	製図/Created 横田	型番/Product number UC32-12-22□ 作成日/Date 2020/01/21	