

構成内容 / Components

No.	名称 / Part name	数量 / Pcs	材質 / Material	色・表面処理 / Color・Finish
1	外部取付足 Bracket	2	ポリカーボネート polycarbonate	ホワイトグレー (RAL7035) White gray (RAL7035)
2	取付ビス (皿 UNF#10-32) Screw (Flat head UNF#10-32)	4	ステンレス Stainless steel	無処理 Unfinished

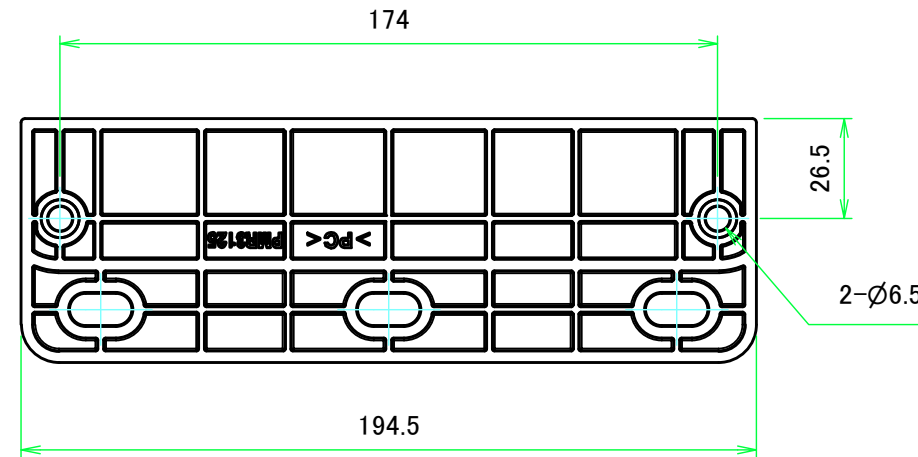
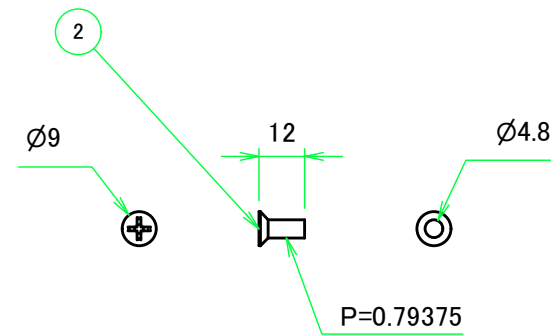
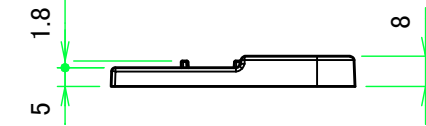
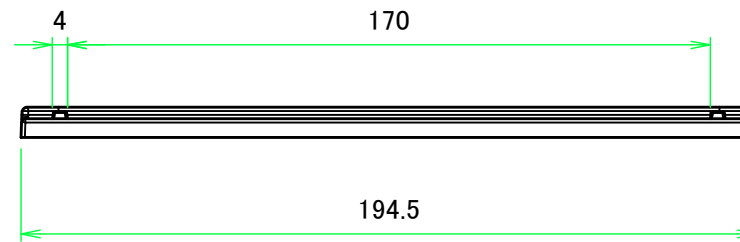
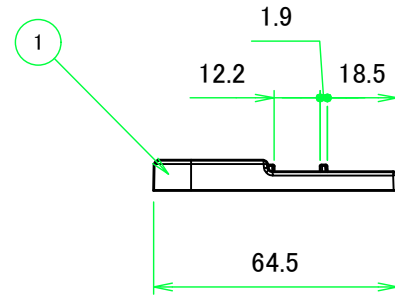
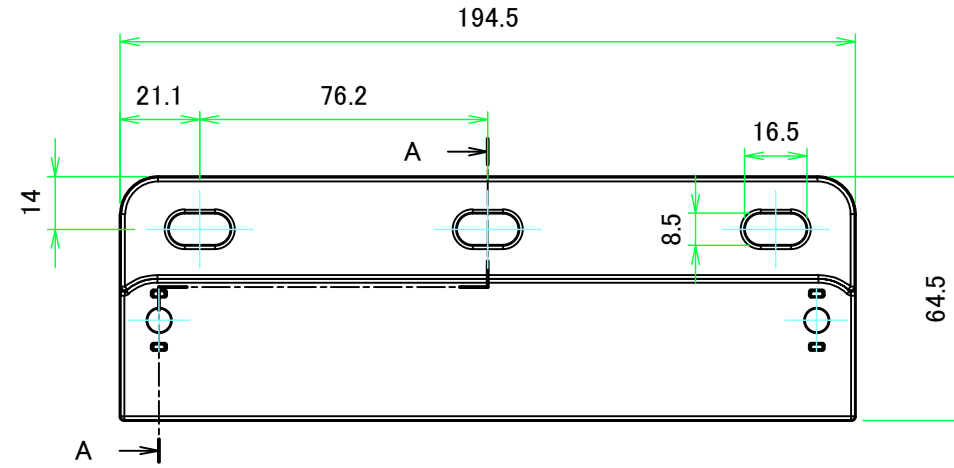
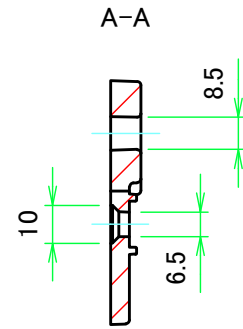

株式会社タカチ電機工業 TAKACHI ELECTRONICS ENCLOSURE CO., LTD.			品名/Title 外部取付足 Wall Mounting bracket for UPC	
承認/Approved	検図/Checked	製図/Created	型番/Product number	尺度/Scale
中根	谷	常山	UMF23	1:2
			作成日/Date	ページ/Page
			2023/04/07	1 / 1
本図面の著作権は株式会社タカチ電機工業に帰属します。 / Copyright (C) TAKACHI ELECTRONICS ENCLOSURE CO., LTD. All Rights Reserved.				